



chevrolet.com (U.S.)
chevrolet.gm.ca (Canada)
chevrolet.com.mx (Mexico)



2015

Traverse



2015 Chevrolet Traverse Owner Manual

In Brief	1-1	Storage	4-1	Phone	7-34
Instrument Panel	1-2	Storage Compartments	4-1	Settings	7-41
Initial Drive Information	1-4	Additional Storage Features	4-3	Trademarks and License	
Vehicle Features	1-17	Roof Rack System	4-5	Agreements	7-43
Performance and		Instruments and Controls	5-1	Climate Controls	8-1
Maintenance	1-26	Controls	5-2	Climate Control Systems	8-1
Keys, Doors, and		Warning Lights, Gauges, and		Air Vents	8-11
Windows	2-1	Indicators	5-11	Maintenance	8-12
Keys and Locks	2-1	Information Displays	5-25	Driving and Operating	9-1
Doors	2-8	Vehicle Messages	5-34	Driving Information	9-2
Vehicle Security	2-12	Vehicle Personalization	5-45	Starting and Operating	9-14
Exterior Mirrors	2-14	Universal Remote System	5-52	Engine Exhaust	9-21
Interior Mirrors	2-16	Lighting	6-1	Automatic Transmission	9-22
Windows	2-17	Exterior Lighting	6-1	Drive Systems	9-25
Roof	2-19	Interior Lighting	6-5	Brakes	9-26
Seats and Restraints	3-1	Lighting Features	6-6	Ride Control Systems	9-28
Head Restraints	3-2	Infotainment System	7-1	Cruise Control	9-30
Front Seats	3-3	Introduction	7-1	Driver Assistance Systems	9-32
Rear Seats	3-9	Radio	7-10	Fuel	9-42
Safety Belts	3-13	Audio Players	7-20	Trailer Towing	9-46
Airbag System	3-23	Rear Seat Infotainment	7-32	Conversions and Add-Ons	9-54
Child Restraints	3-36				

2015 Chevrolet Traverse Owner Manual

Vehicle Care	10-1	Technical Data	12-1
General Information	10-2	Vehicle Identification	12-1
Vehicle Checks	10-3	Vehicle Data	12-2
Headlamp Aiming	10-26	Customer Information	13-1
Bulb Replacement	10-26	Customer Information	13-1
Electrical System	10-28	Reporting Safety Defects	13-12
Wheels and Tires	10-35	Vehicle Data Recording and	
Jump Starting	10-67	Privacy	13-14
Towing the Vehicle	10-70	OnStar	14-1
Appearance Care	10-74	OnStar Overview	14-1
Service and Maintenance ...	11-1	OnStar Services	14-2
General Information	11-1	OnStar Additional	
Maintenance Schedule	11-2	Information	14-6
Special Application		Index	i-1
Services	11-8		
Additional Maintenance			
and Care	11-8		
Recommended Fluids,			
Lubricants, and Parts	11-12		
Maintenance Records	11-14		



The names, logos, emblems, slogans, vehicle model names, and vehicle body designs appearing in this manual including, but not limited to, GM, the GM logo, CHEVROLET, the CHEVROLET Emblem, and TRAVERSE are trademarks and/or service marks of General Motors LLC, its subsidiaries, affiliates, or licensors.

For vehicles first sold in Canada, substitute the name "General Motors of Canada Limited" for Chevrolet Motor Division wherever it appears in this manual.

This manual describes features that may or may not be on the vehicle because of optional equipment that was not purchased on the vehicle, model variants, country specifications, features/applications that may not be available in your region, or changes subsequent to the printing of this owner manual.

Refer to the purchase documentation relating to your specific vehicle to confirm the features.

Keep this manual in the vehicle for quick reference.

Canadian Vehicle Owners

Propriétaires Canadiens

A French language manual can be obtained from your dealer, at www.helminc.com, or from:

On peut obtenir un exemplaire de ce guide en français auprès du concessionnaire ou à l'adresse suivante:

Helm, Incorporated
Attention: Customer Service
47911 Halyard Drive
Plymouth, MI 48170

Using this Manual

To quickly locate information about the vehicle, use the Index in the back of the manual. It is an alphabetical list of what is in the manual and the page number where it can be found.

Danger, Warnings, and Cautions

Warning messages found on vehicle labels and in this manual describe hazards and what to do to avoid or reduce them.



Danger

Danger indicates a hazard with a high level of risk which will result in serious injury or death.



Warning

Warning indicates a hazard that could result in injury or death.



Caution

Caution indicates a hazard that could result in property or vehicle damage.



A circle with a slash through it is a safety symbol which means “Do Not,” “Do not do this,” or “Do not let this happen.”

Symbols

The vehicle has components and labels that use symbols instead of text. Symbols are shown along with the text describing the operation or information relating to a specific component, control, message, gauge, or indicator.

 : This symbol is shown when you need to see your owner manual for additional instructions or information.

 : This symbol is shown when you need to see a service manual for additional instructions or information.

Vehicle Symbol Chart

Here are some additional symbols that may be found on the vehicle and what they mean. For more information on the symbol, refer to the Index.

 : Airbag Readiness Light

 : Antilock Brake System (ABS)

 : Audio Steering Wheel Controls or OnStar® (if equipped)

 : Brake System Warning Light

 : Charging System

 : Cruise Control

 : Engine Coolant Temperature

 : Exterior Lamps









 : Fog Lamps

 : Fuel Gauge

 : Fuses

 : Headlamp High/Low-Beam Changer

 : LATCH System Child Restraints

-  : Malfunction Indicator Lamp
-  : Oil Pressure
-  : Outside Power Foldaway Mirrors
-  : Power
-  : Remote Vehicle Start
-  : Safety Belt Reminders
-  : Tire Pressure Monitor
-  : Tow/Haul Mode
-  : Traction Control/StabiliTrak®
-  : Windshield Washer Fluid

In Brief

Instrument Panel

Instrument Panel 1-2

Initial Drive Information

Initial Drive Information 1-4

Remote Keyless Entry (RKE)

System 1-4

Remote Vehicle Start 1-5

Door Locks 1-5

Liftgate 1-6

Windows 1-7

Seat Adjustment 1-7

Memory Features 1-8

Second Row Seats 1-9

Third Row Seats 1-9

Heated and Cooled Front

Seats 1-10

Head Restraint

Adjustment 1-10

Safety Belts 1-10

Passenger Sensing

System 1-11

Mirror Adjustment 1-11

Steering Wheel

Adjustment 1-12

Interior Lighting 1-13

Exterior Lighting 1-14

Windshield Wiper/Washer 1-14

Climate Controls 1-15

Transmission 1-16

Vehicle Features

Infotainment System 1-17

Radio(s) 1-17

Satellite Radio 1-20

Portable Audio Devices 1-21

Bluetooth® 1-21

Steering Wheel Controls

(Radio without

Touchscreen) 1-21

Steering Wheel Controls

(Radio with

Touchscreen) 1-22

Cruise Control 1-23

Driver Information Center

(DIC) (With DIC Buttons) ... 1-23

Forward Collision Alert (FCA)

System 1-24

Lane Departure

Warning (LDW) 1-24

Side Blind Zone

Alert (SBZA) 1-24

Rear Vision

Camera (RVC) 1-24

Rear Cross Traffic Alert

(RCTA) System 1-24

Parking Assist 1-24

Power Outlets 1-25

Universal Remote System ... 1-25

Sunroof 1-25

Performance and Maintenance

Traction Control/Electronic

Stability Control 1-26

Tire Pressure Monitor 1-26

Engine Oil Life System 1-26

Driving for Better Fuel

Economy 1-27

Roadside Assistance

Program 1-27

OnStar® 1-28

Instrument Panel

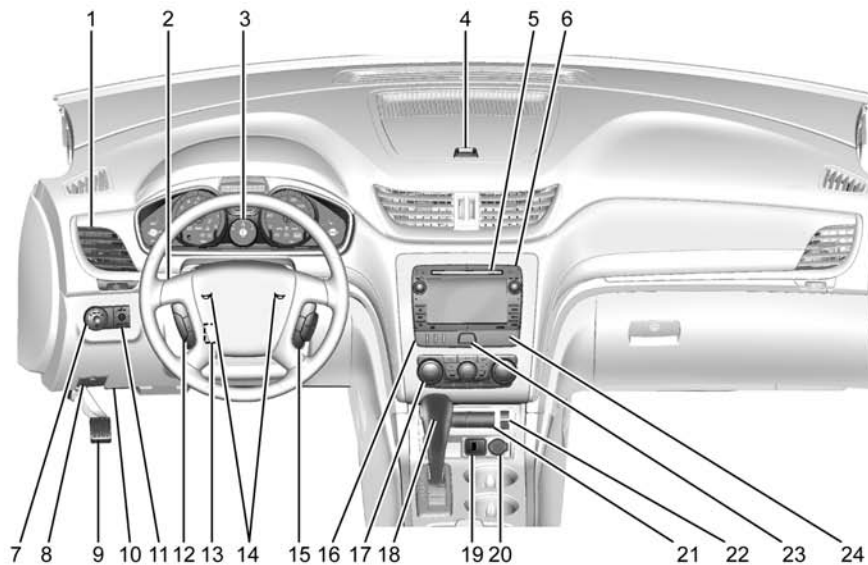

1. *Air Vents on page 8-11.*
2. *Turn Signal Lever. See Turn and Lane-Change Signals on page 6-4 (Out of View). Windshield Wiper/Washer on page 5-5 (Out of View).*
3. *Instrument Cluster on page 5-12.*
4. *Instrument Panel Storage on page 4-1.*
5. *CD Player. See CD Player (Radio with Touchscreen) on page 7-22 or CD Player (Radio without Touchscreen) on page 7-20.*
6. *Infotainment on page 7-1.*
7. *Exterior Lamp Controls on page 6-1. Fog Lamps on page 6-4 (If Equipped).*
8. *Hood Release. See Hood on page 10-4.*
9. *Parking Brake on page 9-27.*
10. *Data Link Connector (DLC) (Out of View). See Malfunction Indicator Lamp on page 5-18.*
11. *Dome Lamp Override. See Dome Lamps on page 6-5. Instrument Panel Illumination Control on page 6-5.*
12. *Cruise Control on page 9-30.*
13. *Steering Wheel Adjustment on page 5-2.*
14. *Horn on page 5-5.*
15. *Steering Wheel Controls (Radio with Touchscreen) on page 5-3 or Steering Wheel Controls (Radio without Touchscreen) on page 5-2 (If Equipped).*
16. *Driver Information Center (DIC) Buttons. See Driver Information Center (DIC) (With DIC Buttons) on page 5-25 or Driver Information Center (DIC) (Without DIC Buttons) on page 5-31.*
17. *Climate Control Systems on page 8-1 (If Equipped). Dual Automatic Climate Control System on page 8-4 (If Equipped).*
18. *Shift Lever. See Shifting Into Park on page 9-19.*
19. *USB Port. See Auxiliary Devices on page 7-31.*
20. *Power Outlets on page 5-9.*

1-4 In Brief

21. *Rear Window Wiper/Washer on page 5-5.*
Traction Control System (TCS) Disable Button. See *Traction Control/Electronic Stability Control on page 9-28.*
Forward Collision Alert (FCA) System on page 9-32 (If Equipped).
Lane Departure Warning (LDW) on page 9-41 (If Equipped).
Tow/Haul Button (If Equipped). See *Tow/Haul Mode on page 9-25.*
Power Liftgate Button (If Equipped). See *Liftgate on page 2-8.*
22. *Heated and Cooled Front Seats on page 3-8 (If Equipped).*
23. *Hazard Warning Flashers on page 6-3.*
24. *Passenger Sensing System on page 3-30.*

Initial Drive Information

This section provides a brief overview about some of the important features that may or may not be on your specific vehicle.

For more detailed information, refer to each of the features which can be found later in this owner manual.

Remote Keyless Entry (RKE) System

The RKE transmitter is used to remotely lock and unlock the doors from up to 60 m (195 ft) away from the vehicle.





Press  to unlock the driver door.

Press  again within five seconds to unlock all remaining doors.

Press  to lock all doors.

Lock and unlock feedback can be personalized.

To open or close the liftgate, press and hold  until the liftgate begins to move.

Press  and release to locate the vehicle.

Press  and hold for more than two seconds to sound the panic alarm.



Press  again to cancel the panic alarm.

See *Remote Keyless Entry (RKE) System Operation* on page 2-2.

Remote Vehicle Start

Starting the Vehicle

With this feature the engine can be started from outside of the vehicle.

1. Aim the RKE transmitter at the vehicle.
2. Press and release .
3. Immediately after completing Step 2, press and hold  until the parking lamps flash.

When the vehicle starts, the parking lamps will turn on and remain on as long as the engine is running. The doors will be locked and the climate control system may come on.

The engine will continue to run for 10 minutes. Repeat the steps for a 10-minute time extension. Remote start can be extended only once.

Canceling a Remote Start



To cancel a remote start:

- Aim the RKE transmitter at the vehicle and press and hold  until the parking lamps turn off.
- Turn on the hazard warning flashers.
- Turn the ignition switch on and then off.

See *Remote Vehicle Start* on page 2-4.

Door Locks

To lock or unlock a door manually:

- From the inside use the door lock knob on the window sill.
- From the outside turn the key toward the front or rear of the vehicle, or press the  or  button on the Remote Keyless Entry (RKE) transmitter.

Power Door Locks



Base Model

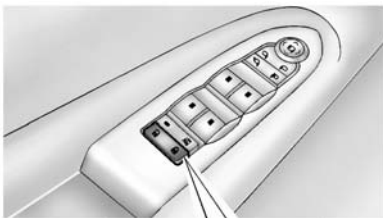

Uplevel Model

 : Press to unlock the doors.

 : Press to lock the doors.

See *Power Door Locks* on page 2-7.

Liftgate

To open the liftgate the vehicle must be in P (Park). Press the touch pad under the liftgate handle and lift up. To close the liftgate, use the pull cup or pull strap as an aid.

Power Liftgate

If equipped with a power liftgate, the vehicle must be in P (Park) to operate it.

- Press and hold  on the Remote Keyless Entry (RKE) transmitter.

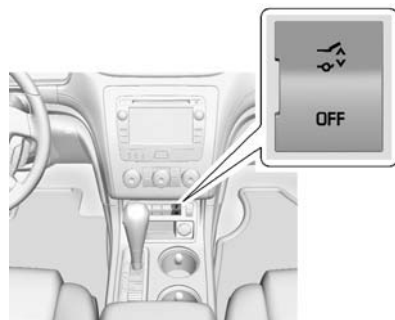

- Press .
- Press the touch pad on the outside liftgate handle.

See *Liftgate* on page 2-8.

Windows



Uplevel Shown, Base Similar

Press the switch to lower the window. Pull the switch up to raise it.

For more information, see *Power Windows* on page 2-17.

Seat Adjustment

Manual Seats

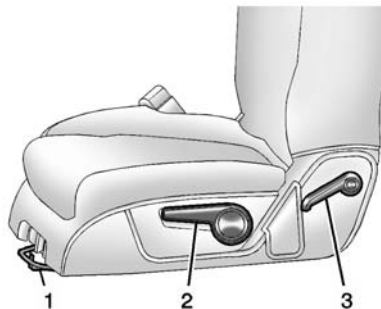

1. Seat Adjustment Handle
2. Driver Seat Height Adjustment Lever
3. Seatback Lever

To adjust a manual seat:

1. Lift the handle (1) under the seat to unlock it.
2. Slide the seat to the desired position, and then release the handle (1).
3. Try to move the seat back and forth to be sure it is locked in place.

Move the lever (2) up or down to raise or lower the seat.

Use the lever (3) to adjust the seatback.

See *Seat Adjustment* on page 3-3 and *Reclining Seatbacks* on page 3-5.

1-8 In Brief

Power Seats

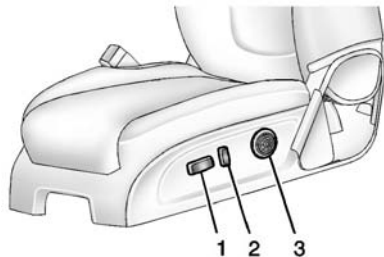

1. Seat Adjustment Control
2. Seatback Control
3. Lumbar Control

To adjust a power seat, if equipped:

- Move the seat forward or rearward by sliding the control (1) forward or rearward.
- Raise or lower the front part of the seat cushion by moving the front of the control (1) up or down.

- Raise or lower the entire seat by moving the rear of the control (1) up or down.
- Adjust the seatback by tilting the top of the control (2) forward or rearward.

See *Reclining Seatbacks* on page 3-5.

- Increase or decrease lumbar support by pressing the front or rear of the control (3).

See *Lumbar Adjustment* on page 3-4.

See *Power Seat Adjustment* on page 3-4.

Memory Features

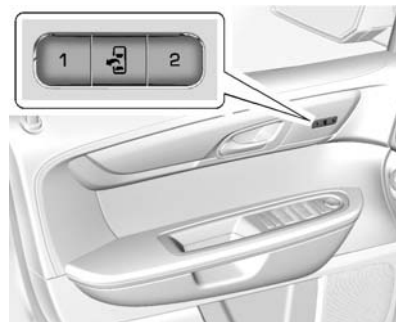

If equipped, the controls on the driver door are used to program and recall memory settings for the driver seat and outside mirrors.

See *Memory Seats* on page 3-6 and *Vehicle Personalization (With DIC Buttons)* on page 5-45.

Second Row Seats

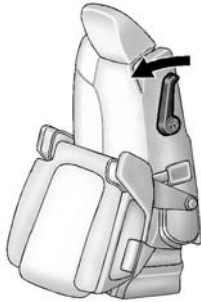

The second row seat can be folded to access the third row. Pull the sliding seat lever forward; the seat cushion folds, and the seat slides forward.

See *Rear Seats* on page 3-9.

Third Row Seats

The third row seatbacks can be folded forward, and the seats can be removed.

To fold the third row seatback:

1. Remove anything on or under the seat.

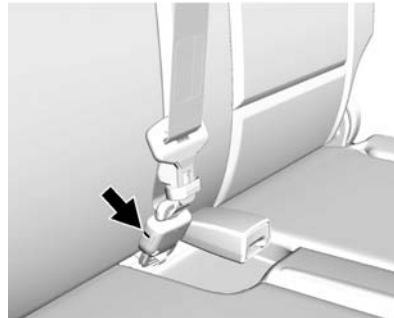

2. Disconnect the rear safety belt mini-latch using a key in the slot on the mini-buckle, and let the belt retract into the headliner. Stow the mini-latch in the holder in the headliner.



3. Pull up on the release lever on the back of the seat.
4. Push the seatback forward to lay flat.

See *Third Row Seats* on page 3-11.

Heated and Cooled Front Seats



Heated and Cooled Seat Buttons Shown, Heated Seat Buttons Similar

If equipped, the buttons are on the center stack. To operate, the engine must be running.

 : If equipped, press to heat the seatback only.

 : If equipped, press to cool the entire seat.

 : Press to heat the seat and seatback.

Press the button once for the highest setting. With each press of the button, the seat will change to the next lower setting, and then to the off setting. The lights indicate three for the highest setting and one for the lowest.

See *Heated and Cooled Front Seats* on page 3-8.

Head Restraint Adjustment

Do not drive until the head restraints for all occupants are installed and adjusted properly.

To achieve a comfortable seating position, change the seatback recline angle as little as necessary while keeping the seat and the head restraint height in the proper position.

See *Head Restraints* on page 3-2 and *Seat Adjustment* on page 3-3.

Safety Belts



Refer to the following sections for important information on how to use safety belts properly:

- *Safety Belts* on page 3-13.
- *How to Wear Safety Belts Properly* on page 3-15.
- *Lap-Shoulder Belt* on page 3-16.
- *Lower Anchors and Tethers for Children (LATCH System)* on page 3-44.

Passenger Sensing System



United States



Canada and Mexico

The passenger sensing system will turn off the front outboard passenger frontal airbag under certain conditions. No other airbag is affected by the passenger sensing system. See *Passenger Sensing System* on page 3-30.

The passenger airbag status indicator will light on the instrument panel when the vehicle is started. See *Passenger Airbag Status Indicator* on page 5-17.

Mirror Adjustment

Exterior Mirrors



Base Model

To adjust the mirrors:

1. Press ◀ or ▶ to select a mirror.
2. Press the control pad to adjust the mirror.

3. Return the switch to the center to deselect the mirror.

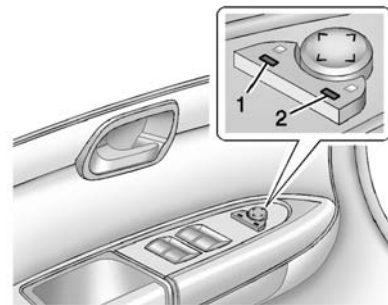

Uplevel Model

To adjust the mirrors:

1. Press (1) or (2) to select a mirror.
2. Press the control pad to adjust the mirror.
3. Press (1) or (2) again to deselect the mirror.

Folding Mirrors

For vehicles with manual folding mirrors, push the mirror toward the vehicle. Pull the mirror out to return to its original position.

For vehicles with power folding mirrors:

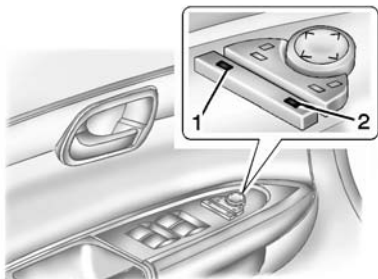

1. Press (1) to fold the mirrors out to the driving position.
2. Press (2) to fold the mirrors in to the folded position.

See *Folding Mirrors* on page 2-15.

Interior Mirror

Adjustment

Adjust the rearview mirror to clearly view the area behind the vehicle.

Manual Rearview Mirror

For vehicles with a manual rearview mirror, push the tab forward for daytime use and pull it for nighttime use to avoid glare from the headlamps from behind. See *Manual Rearview Mirror* on page 2-17.

Automatic Dimming Rearview Mirror

The mirror will automatically reduce the glare from the headlamps from behind. The dimming feature comes on when the vehicle is started. See *Automatic Dimming Rearview Mirror* on page 2-17.

Steering Wheel Adjustment



To adjust the steering wheel:

1. Pull the lever down.
2. Move the steering wheel up or down.

- Pull or push the steering wheel closer or away from you.
- Push the lever up to lock the steering wheel in place.

Do not adjust the steering wheel while driving.

Interior Lighting

Dome Lamps

The dome lamps are in the overhead console and above the rear seat passengers.

The dome lamps come on when a door is opened, unless the dome lamp override button is pressed in.

To manually turn them on, turn the instrument panel brightness control clockwise to the farthest position.

Dome Lamp Override

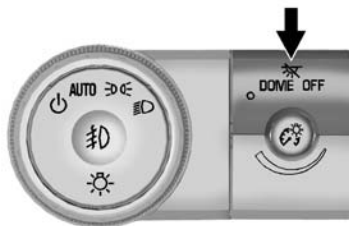

The dome lamp override button is next to the exterior lamps control.

☾ DOME OFF: Press the button and the dome lamps remain off when a door is opened. An indicator light on the button comes on to show that the dome lamps are off. Press the button again so the dome lamps come on when a door is opened.

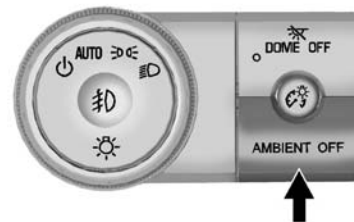

AMBIENT OFF (If Equipped):

Press the button to turn the ambient lights off. Press the button again to turn ambient lights on.

Reading Lamps

Press the button near each lamp to turn them on or off.

For more information, see:

- Dome Lamps on page 6-5.*
- Instrument Panel Illumination Control on page 6-5.*

Exterior Lighting

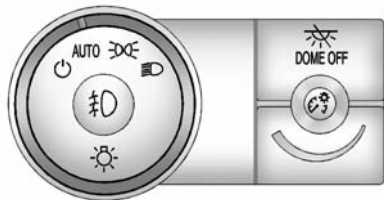

The exterior lamp control is on the instrument panel, to the left of the steering wheel.

OFF : Briefly turn to this position to turn the automatic light control off or on again.

AUTO : Turns the headlamps on automatically at normal brightness, together with the other exterior lamps and instrument panel lights.

☰ : Turns on the parking lamps including all lamps, except the headlamps.

☰ : Turns on the headlamps together with the parking lamps and instrument panel lights. A warning chime sounds if the driver door is opened when the ignition switch is off and the headlamps are on.

☰ : If equipped, it turns the fog lamps on or off.

See:

- *Exterior Lamp Controls on page 6-1*
- *Fog Lamps on page 6-4*

Windshield Wiper/Washer

The windshield wiper/washer lever is located on the left side of the steering column.

Turn the band with the wiper symbol to control the windshield wipers.



☰ : Use for a single wiping cycle.

OFF : Use to turn the wipers off.

☰ : Delays wiping cycle. Turn the band up for more frequent wipes or down for less frequent wipes.

LO : Slow wipes.

HI : Fast wipes.

Windshield Washer

☰ **FRONT** : Press the button at the end of the lever to spray washer fluid on the windshield.

Rear Window Wiper/Washer

The rear wiper and rear wash button is on the center stack below the climate control system.

 : Press to turn the rear wiper on and off. The wiper speed cannot be changed.

 : Press to spray washer fluid on the rear window. The window wiper will also come on.

See *Windshield Wiper/Washer* on page 5-5 and *Rear Window Wiper/Washer* on page 5-5.

Climate Controls

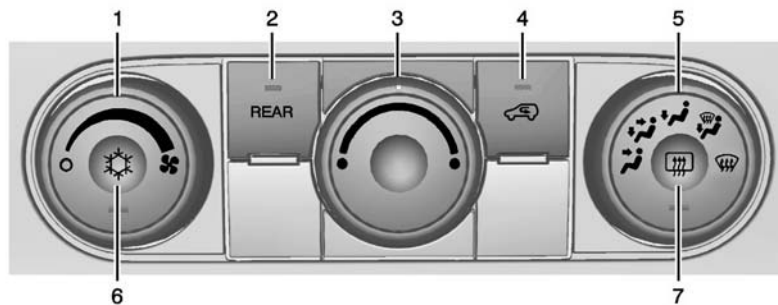

1. Fan Control
2. REAR (Rear Climate Control)
3. Temperature Control
4. Recirculation
5. Air Delivery Mode Control
6. Air Conditioning
7. Rear Window Defogger

Dual Automatic Climate Control System

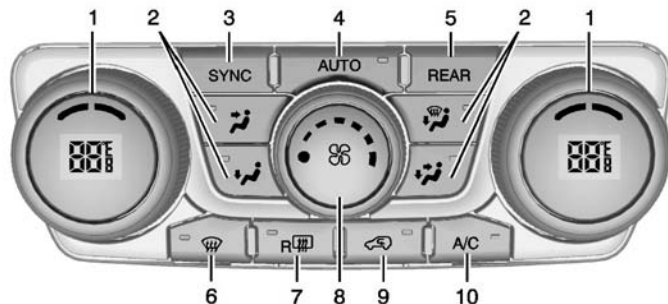

1. Driver and Passenger Side Temperature Controls
 2. Air Delivery Mode Controls
 3. SYNC (Synchronized Temperature)
 4. AUTO (Automatic Operation)
 5. REAR (Rear Climate Control)
 6. Defrost
 7. Rear Window Defogger
 8. Fan Control
 9. Recirculation
 10. A/C (Air Conditioning)
- See *Climate Control Systems on page 8-1* or *Dual Automatic Climate Control System on page 8-4* (If Equipped). For more information about the rear climate control, see *Rear Climate Control System on page 8-9* or *Rear Climate Control System (with Rear Seat Audio) on page 8-10*.

Transmission

Electronic Range Select (ERS) Mode

ERS mode allows you to choose the top-gear limit of the transmission and the vehicle's speed while driving downhill or towing a trailer. The vehicle has an electronic shift position indicator within the instrument cluster. When using the ERS mode a number will display next to the L, indicating the current gear that has been selected.

To use this feature:

1. Move the shift lever to L (Low).
2. Press the plus/minus button on the shift lever, to increase or decrease the gear range available.

See *Manual Mode on page 9-24*.

Vehicle Features

Infotainment System

If the vehicle has a base radio it is included in this manual. See the separate infotainment manual for information on the connected radios, audio players, phone, navigation system, and voice or speech recognition. There is also information on settings and downloadable applications (if equipped).

Radio(s)

Radio without Touchscreen



⏻ : Press to turn the system on and off. Turn to increase or decrease the volume.

BAND: Press to choose between FM, AM, or SiriusXM[®], if equipped.

🎵 : Select radio stations or set Tone options.

⏪ or ⏩ : Seek or scan stations or tracks.

i: Change the display between the radio station frequency and the time, if equipped. While the ignition is off, press **i** to display the time.

For more information about these and other radio features, see *Operation (Radio without Touchscreen)* on page 7-5 or *Operation (Radio with Touchscreen)* on page 7-8.

If equipped with Rear Seat Entertainment (RSE), see the infotainment manual.



Storing a Favorite Station

A maximum of 36 stations can be stored as favorites using the six softkeys located below the radio station frequency tabs and by using the radio FAV button. Press FAV to go through up to six pages of favorites, each having six favorite stations available per page. Each page of favorites can contain any combination of AM, FM, or SiriusXM stations, if equipped.

See *AM-FM Radio (Radio without Touchscreen)* on page 7-10 or *AM-FM Radio (Radio with Touchscreen)* on page 7-12.

Setting the Clock

To set the time and date:

1. Turn the ignition key to ACC/ACCESSORY or ON/RUN, then press  to turn the radio on.
2. Press  to display HR, MIN, MM, DD, YYYY (hour, minute, month, day, and year).
3. Press the pushbutton located under any one of the labels to be changed.
4. To increase or decrease the time or date, turn  clockwise or counterclockwise.

See *Clock (Radio without Touchscreen)* on page 5-7 or *Clock (Radio with Touchscreen)* on page 5-8.

Radio with Touchscreen



PUSH/⏻ : Press to turn the system on and off. Turn to adjust the volume.

⏏ : Press to eject a disc from the CD. See *CD Player (Radio with Touchscreen)* on page 7-22 or *CD Player (Radio without Touchscreen)* on page 7-20.

AUX Port: 3.5 mm (1/8 in) connection for external audio devices.

PUSH/SEL: Turn to manually find a station or highlight a menu selection. Press to select a highlighted selection.

🏠 : Press to go to the Home Page. See “Home Page” in *Operation (Radio without Touchscreen)* on page 7-5 or *Operation (Radio with Touchscreen)* on page 7-8.

SRCE: Press to change the audio source to AM, FM, CD, and if equipped, SiriusXM®, front auxiliary, rear auxiliary, and iPod/USB.

FAV: Press to display the favorite list or add a favorite. See *Operation (Radio without Touchscreen)* on page 7-5 or *Operation (Radio with Touchscreen)* on page 7-8.

⏪ SEEK or SEEK ⏩ : Seek or scan stations and tracks. See *Operation (Radio without Touchscreen)* on page 7-5 or *Operation (Radio with Touchscreen)* on page 7-8.

⏪ BACK : Press to return to the previous screen in a menu.

Storing Radio Station Presets

Up to 30 preset stations can be stored. AM, FM, and SiriusXM (if equipped) can be mixed.

1. From the AM, FM, or SiriusXM main page, press and hold any 1–5 buttons or one of the preset screen buttons at the bottom of the screen. After a few seconds, a beep is heard and the new preset information displays on that screen button.
2. Repeat for each preset.

Setting the Clock

Press Settings on the Home Page, then press the Set Time or Set Date settings screen button to display the different options for setting the time and date.

Set Time:

- Press the up or down arrows to change the Hours, Minutes, AM, PM, or 24 hour setting on the clock.

- Press and hold to quickly increase or decrease the time settings.
- Press OK to save the adjustments.
- Press the Back or Cancel screen button to cancel the adjustments.

Set Date:

- Press the up or down arrows to increase or decrease the Month, Day, and Year settings.
- Press and hold to quickly increase or decrease the date settings.
- Press OK to save the adjustments.
- Press the Back or Cancel screen button to cancel the adjustments.

Satellite Radio

If equipped, vehicles with a SiriusXM[®] satellite radio tuner and a valid SiriusXM satellite radio subscription can receive SiriusXM programming.

SiriusXM Satellite Radio Service

SiriusXM is a satellite radio service based in the 48 contiguous United States and 10 Canadian provinces. SiriusXM satellite radio has a wide variety of programming and commercial-free music, coast to coast, and in digital-quality sound. A fee is required to receive the SiriusXM service.

Refer to:

- www.siriusxm.com or call 1-866-635-2349 (U.S.).
- www.xmradio.ca or call 1-877-209-0079 (Canada).

See *Satellite Radio (Radio without Touchscreen)* on page 7-15 or *Satellite Radio (Radio with Touchscreen)* on page 7-18.

Portable Audio Devices

The vehicle has a 3.5 mm (1/8 in) auxiliary input jack on the faceplate and a USB port in the center stack. External devices such as iPods, laptop computers, MP3 players, CD changers, USB storage devices, etc. can be connected to the auxiliary port using a 3.5 mm (1/8 in) input jack or the USB port depending on the audio system.

If equipped, there are two USB ports on the rear of the center console that can be used for charging only. They can charge devices that draw 2.1 amps or less. See the device's owner manual for the specification.

See *Auxiliary Devices* on page 7-31.

Bluetooth®

The Bluetooth® system allows users with a Bluetooth-enabled mobile phone to make and receive hands-free calls using the vehicle audio system and controls.

The Bluetooth-enabled mobile phone must be paired with the in-vehicle Bluetooth system before it can be used in the vehicle. Not all phones will support all functions.

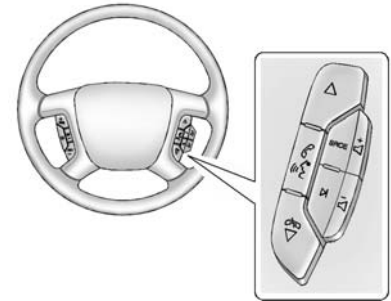

See *Bluetooth* on page 7-34.

Steering Wheel Controls (Radio without Touchscreen)





Δ or \rightarrow / ∇ : Press to change favorite radio stations, select tracks on a CD, or navigate tracks or folders on an iPod or USB device.

$\text{Speaker with slash}$: Press to mute the speakers, press again to unmute. Press and hold to interact with Bluetooth and OnStar®, if equipped.

  : Press to reject an incoming call, or end a current call.

SRCE: Press to switch between AM, FM, CD, and if equipped, SiriusXM[®], front auxiliary, rear auxiliary, and iPod/USB.



 : Press to seek the next radio station, track, or chapter while sourced to the CD slot, or to select tracks and folders on an iPod or USB device.

+  or -  : Press to increase or to decrease the volume.

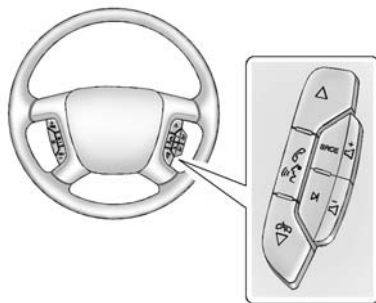

See *Steering Wheel Controls (Radio with Touchscreen)* on page 5-3 or *Steering Wheel Controls (Radio without Touchscreen)* on page 5-2.

Steering Wheel Controls (Radio with Touchscreen)



 or   : Press to change favorite radio stations, select tracks on a CD, or navigate tracks or folders on an iPod or USB device.



  : Press to interact with Bluetooth and OnStar[®], if equipped.

  : Press to reject an incoming call, or end a current call.

SRCE: Press to switch between AM, FM, CD, and if equipped, SiriusXM[®], front auxiliary, rear auxiliary, and iPod/USB.

Press and hold to mute/pause the system.

 : Press to seek the next radio station, track, or chapter while sourced to the CD slot, or to select tracks and folders on an iPod or USB device.

+  or -  : Press to increase or to decrease the volume.

See *Steering Wheel Controls (Radio with Touchscreen)* on page 5-3 or *Steering Wheel Controls (Radio without Touchscreen)* on page 5-2.

Cruise Control

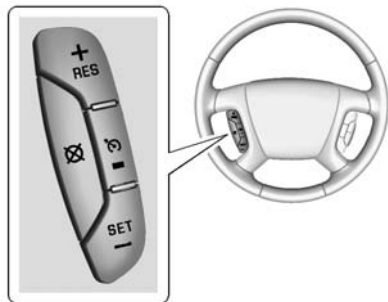

 : Press to turn cruise control on or off. The indicator light on the button comes on when the cruise control is on.

+RES: If there is a set speed in memory, press briefly to resume to that speed or press and hold to accelerate. If cruise control is already active, use to increase vehicle speed.

SET-: Press briefly to set the speed and activate cruise control. If cruise control is already active, use to decrease vehicle speed.

 : Press to disengage cruise control without erasing the set speed from memory.

See *Cruise Control* on page 9-30.

Driver Information Center (DIC) (With DIC Buttons)

To access the DIC, some vehicles have buttons located on the instrument panel.



 : Press to set or reset certain functions and to turn off or acknowledge messages on the DIC.

 : Press to customize the feature settings on your vehicle. See *Vehicle Personalization (With DIC Buttons)* on page 5-45 for more information.

 : Press to display the oil life, park assist on vehicles with this feature, units, tire pressure readings on vehicles with this feature, and compass calibration and zone setting on vehicles with this feature.

 : Press this button to display the odometer, trip odometers, fuel range, average economy, timer, fuel used, and average speed.

Some vehicles do not have the buttons shown, however some of the menus can be viewed by using the trip odometer reset stem.

See *Driver Information Center (DIC) (With DIC Buttons)* on page 5-25 or *Driver Information Center (DIC) (Without DIC Buttons)* on page 5-31.

Forward Collision Alert (FCA) System

If equipped, FCA may help avoid or reduce the harm caused by front-end crashes. FCA provides a green indicator, , when a vehicle is detected ahead. This indicator displays amber if you follow a vehicle much too closely. When approaching a vehicle ahead too quickly, FCA provides a red flashing alert on the windshield and rapidly beeps.

See *Forward Collision Alert (FCA) System* on page 9-32.

Lane Departure Warning (LDW)

If equipped, LDW may help avoid unintentional lane departures at speeds of 56 km/h (35 mph) or greater. LDW uses a camera sensor to detect the lane markings. The LDW light, , is green if a lane marking is detected. If the vehicle

departs the lane, the light will change to amber and flash. In addition, beeps will sound.

See *Lane Departure Warning (LDW)* on page 9-41.

Side Blind Zone Alert (SBZA)

If equipped, SBZA will detect vehicles in the next lane over in the vehicle's side blind zone area. When this happens, the SBZA display will light up in the corresponding outside side mirror and will flash if the turn signal is on.

See *Side Blind Zone Alert (SBZA)* on page 9-36.

Rear Vision Camera (RVC)

If equipped, RVC displays a view of the area behind the vehicle, on the center stack display, when the vehicle is shifted into R (Reverse).

See *Rear Vision Camera (RVC)* on page 9-38.

Rear Cross Traffic Alert (RCTA) System

If equipped, when backing, the RCTA system uses a triangle with an arrow displayed on the RVC screen to warn of traffic behind your vehicle that may cross your vehicle's path. In addition, beeps will sound.

See "Rear Cross Traffic Alert (RCTA)" under *Rear Vision Camera (RVC)* on page 9-38.

Parking Assist

If equipped, this system uses sensors on the rear bumper to assist with parking and avoiding objects while in R (Reverse). It operates at speeds less than 8 km/h (5 mph). Rear Parking Assist (RPA) uses audible beeps to provide distance and system information.

Keep the sensors on the vehicle's rear bumper clean to ensure proper operation.

See *Parking Assist* on page 9-34.

Power Outlets

The vehicle has 12-volt accessory power outlets, which can be used to plug in electrical equipment, such as a cell phone or MP3 player.

The power outlets are located:

- On the center stack below the climate controls.
- Inside the center console.
- At the rear of the center console.
- In the rear cargo area.

To use the outlets, remove the cover.

See *Power Outlets* on page 5-9.

Universal Remote System



If equipped, the Universal Home Remote System allows for garage door openers, security systems, and home automation devices to be programmed to work with these buttons in the vehicle.

See *Universal Remote System* on page 5-52.

Sunroof

The ignition must be in ON/RUN or ACC/ACCESSORY, or Retained Accessory Power (RAP) must be active to operate the sunroof and power sunshade. See *Retained Accessory Power (RAP)* on page 9-18.

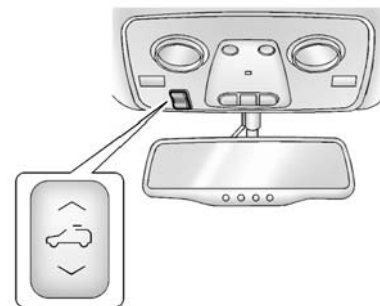

Vent: Press the front or rear of the switch to vent or close the sunroof.



Express-open/Express-close: Press and release the rear or front of the switch to express-open or express-close the sunroof.

See *Sunroof* on page 2-19.

Performance and Maintenance

Traction Control/ Electronic Stability Control

The vehicle has a traction control system that limits wheel spin, and the StabiliTrak system that assists with directional control of the vehicle in difficult driving conditions. Both systems turn on automatically every time the vehicle is started.

- To turn off traction control and StabiliTrak, press and release  on the center stack, and the appropriate DIC message displays. See *Ride Control System Messages* on page 5-41.
- Press and release  again to turn on both systems.

See *Traction Control/Electronic Stability Control* on page 9-28.

Tire Pressure Monitor

This vehicle may have a Tire Pressure Monitor System (TPMS).



The low tire pressure warning light alerts to a significant loss in pressure of one of the vehicle's tires. If the warning light comes on, stop as soon as possible and inflate the tires to the recommended pressure shown on the Tire and Loading Information label. See *Vehicle Load Limits* on page 9-9. The warning light will remain on until the tire pressure is corrected.

The low tire pressure warning light may come on in cool weather when the vehicle is first started, and then turn off as the vehicle is driven. This may be an early indicator that the

tire pressures are getting low and the tires need to be inflated to the proper pressure.

The TPMS does not replace normal monthly tire maintenance. Maintain the correct tire pressures.

See *Tire Pressure Monitor System* on page 10-44.

Engine Oil Life System

The engine oil life system calculates engine oil life based on vehicle use and displays the CHANGE ENGINE OIL SOON message when it is time to change the engine oil and filter. The oil life system should be reset to 100% only following an oil change.

Resetting the Oil Life System

1. Turn the ignition to ON/RUN, with the engine off.

- If the vehicle has Driver Information Center (DIC) buttons: Press the vehicle information button until OIL LIFE REMAINING displays.

If the vehicle does not have Driver Information Center (DIC) buttons: The vehicle must be in P (Park) to access this display. Press the trip odometer reset stem until OIL LIFE REMAINING displays.

- If the vehicle has Driver Information Center (DIC) buttons: Press and hold the set/reset button until "100%" is displayed. Three chimes sound and the CHANGE ENGINE OIL SOON message goes off.

If the vehicle does not have Driver Information Center (DIC) buttons: Press and hold the trip odometer reset stem until OIL LIFE REMAINING shows "100%." Three chimes sound and the CHANGE ENGINE OIL SOON message goes off.

- Turn the key to LOCK/OFF.

See *Engine Oil Life System* on page 10-9.

Driving for Better Fuel Economy

Driving habits can affect fuel mileage. Here are some driving tips to get the best fuel economy possible.

- Avoid fast starts and accelerate smoothly.
- Brake gradually and avoid abrupt stops.
- Avoid idling the engine for long periods of time.
- When road and weather conditions are appropriate, use cruise control.
- Always follow posted speed limits or drive more slowly when conditions require.
- Keep vehicle tires properly inflated.

- Combine several trips into a single trip.
- Replace the vehicle's tires with the same TPC Spec number molded into the tire's sidewall near the size.
- Follow recommended scheduled maintenance.

Roadside Assistance Program

U.S.: 1-800-243-8872

TTY Users (U.S. Only):
1-888-889-2438

Canada: 1-800-268-6800

New Chevrolet owners are automatically enrolled in the Roadside Assistance Program.

See *Roadside Assistance Program* on page 13-5.

OnStar®

This vehicle may be equipped with a comprehensive, in-vehicle system that can connect to a live OnStar Advisor for Emergency, Security, Navigation, Connection, and Diagnostic Services. OnStar services may require a paid subscription. See *OnStar Overview* on page 14-1.

Keys, Doors, and Windows

Keys and Locks

- Keys 2-1
- Remote Keyless Entry (RKE) System 2-2
- Remote Keyless Entry (RKE) System Operation 2-2
- Remote Vehicle Start 2-4
- Door Locks 2-6
- Power Door Locks 2-7
- Delayed Locking 2-7
- Automatic Door Locks 2-7
- Lockout Protection 2-7
- Safety Locks 2-8

Doors

- Liftgate 2-8

Vehicle Security

- Vehicle Security 2-12
- Vehicle Alarm System 2-12
- Immobilizer 2-13
- Immobilizer Operation 2-13

Exterior Mirrors

- Convex Mirrors 2-14
- Power Mirrors 2-15
- Folding Mirrors 2-15
- Heated Mirrors 2-16
- Park Tilt Mirrors 2-16

Interior Mirrors

- Interior Rearview Mirrors 2-16
- Manual Rearview Mirror 2-17
- Automatic Dimming Rearview Mirror 2-17

Windows

- Windows 2-17
- Power Windows 2-17
- Sun Visors 2-19

Roof

- Sunroof 2-19

Keys and Locks

Keys

 **Warning**

Leaving children in a vehicle with the ignition key is dangerous and children or others could be seriously injured or killed. They could operate the power windows or other controls or make the vehicle move. The windows will function with the keys in the ignition, and children or others could be caught in the path of a closing window. Do not leave children in a vehicle with the ignition key.

2-2 Keys, Doors, and Windows



The key is used for the ignition and all door locks.

The key has a bar-coded key tag that the dealer or qualified locksmith can use to make new keys. Store this information in a safe place, not in the vehicle.

If it becomes difficult to turn the key, inspect the key blade for debris.

See your dealer if a replacement key or additional key is needed.

If locked out of the vehicle, call Roadside Assistance. See *Roadside Assistance Program* on page 13-5.

If equipped, with an active OnStar subscription, an OnStar Advisor may remotely unlock the vehicle. See "OnStar," if equipped.

Remote Keyless Entry (RKE) System

See *Radio Frequency Statement* on page 13-12.

If there is a decrease in the RKE operating range:

- Check the distance. The transmitter may be too far from the vehicle.
- Check the location. Other vehicles or objects may be blocking the signal.
- Check the transmitter's battery. See "Battery Replacement" later in this section.
- If the transmitter is still not working correctly, see your dealer or a qualified technician for service.

Remote Keyless Entry (RKE) System Operation

The RKE transmitter functions work up to 60 m (195 ft) away from the vehicle.

Other conditions can affect the performance of the transmitter. See *Remote Keyless Entry (RKE) System* on page 2-2.





With Remote Start and Power Liftgate Shown, Without Similar



Ⓞ (Remote Vehicle Start):

If equipped, see *Remote Vehicle Start* on page 2-4.

 **(Lock):** Press to lock all the doors.

If enabled through the Driver Information Center (DIC), the parking lamps flash once to indicate locking has occurred. If enabled through the DIC, the horn sounds when  is pressed again within five seconds. See *Vehicle Personalization (With DIC Buttons)* on page 5-45.

Pressing  may arm the content theft-deterrent system. See *Vehicle Alarm System* on page 2-12.



 **(Unlock):** Press once to unlock only the driver door. If  is pressed again within five seconds, all remaining doors unlock. The interior lamps come on and stay on for 20 seconds or until the ignition is turned on.

If enabled through the DIC, the parking lamps flash twice to indicate unlocking has occurred. See *Vehicle Personalization (With DIC Buttons)* on page 5-45.

Pressing  on the RKE transmitter disarms the content theft-deterrent system. See *Vehicle Alarm System* on page 2-12.

 **(Power Liftgate):** Press and hold until the liftgate begins to move to open or close the liftgate. The taillamps flash and a chime sounds to indicate when the liftgate is opening or closing.

 **(Vehicle Locator/Panic Alarm):** Press and release to locate the vehicle. The parking lamps flash and the horn sounds three times.

Press and hold  for more than two seconds to activate the panic alarm. The parking lamps flash and the horn sounds repeatedly for 30 seconds. The alarm turns off when the ignition is moved to ON/RUN or  is pressed again. The ignition must be in LOCK/OFF for the panic alarm to work.

Programming Transmitters to the Vehicle

Only RKE transmitters programmed to this vehicle will work. If a transmitter is lost or stolen, a replacement can be purchased and programmed through your dealer. When the replacement transmitter is programmed to this vehicle, all remaining transmitters must also be reprogrammed. Any lost or stolen transmitters will no longer work once the new transmitter is programmed. Each vehicle can have up to eight transmitters programmed to it. See your dealer to program transmitters to this vehicle.

Battery Replacement

Replace the battery if the REPLACE BATTERY IN REMOTE KEY message displays in the DIC.

2-4 Keys, Doors, and Windows

Caution

When replacing the battery, do not touch any of the circuitry on the transmitter. Static from your body could damage the transmitter.

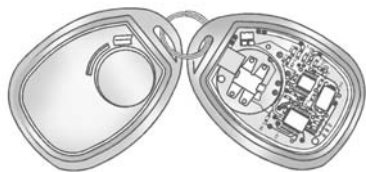

1. Separate the transmitter with a flat, thin object, such as a flat head screwdriver.
 - Carefully insert the tool into the notch located along the parting line of the

transmitter. Do not insert the tool too far. Stop as soon as resistance is felt.

- Twist the tool until the transmitter is separated.
2. Remove the old battery. Do not use a metal object.
 3. Insert the new battery, positive side facing down. Replace with a CR2032 or equivalent battery.
 4. Snap the transmitter back together.

Remote Vehicle Start

This vehicle may have a remote starting feature that starts the engine from outside of the vehicle.

Ⓚ (Remote Start): This button is on the RKE transmitter if the vehicle has remote start.

Laws in some communities may restrict the use of remote starters. For example, some laws may require a person using the remote start to have the vehicle in view

when doing so. Check local regulations for any requirements on remote starting of vehicles.



Do not use the remote start feature if the vehicle is low on fuel. The vehicle could run out of fuel.

If the vehicle has the remote start feature, the RKE transmitter range may be less while the vehicle is running.

Other conditions can affect the performance of the transmitter. See *Remote Keyless Entry (RKE) System* on page 2-2.

Starting the Engine Using Remote Start

To start the vehicle:

1. Aim the RKE transmitter at the vehicle.
2. Press and release  on the RKE transmitter.
3. Immediately after completing Step 2, press and hold  until the parking lamps flash. If the

vehicle's lights cannot be seen, press and hold  for at least four seconds.

When the vehicle starts, the parking lamps will turn on and remain on as long as the engine is running. The doors will be locked and the climate control system will operate automatically if the vehicle has the automatic system, or at the same setting as when the vehicle was last turned off.

If the vehicle has an automatic climate control system and heated seats, the heated seats turn on during colder outside temperatures and shut off when the key is turned to ON/RUN. See *Heated and Cooled Front Seats* on page 3-8.

The rear window defogger and heated mirrors, if the vehicle has them, turn on during colder outside temperatures and turn off when the key is turned to ON/RUN.



After entering the vehicle during a remote start, insert and turn the key to the ON/RUN position to drive the vehicle.

If the vehicle is left running it automatically shuts off after 10 minutes unless a time extension has been done.

Extending Engine Run Time

To extend the engine run time by 10 minutes, repeat Steps 1–3 while the engine is still running. The engine run time can only be extended if it is the first remote start since the vehicle has been driven. Remote start can be extended one time.

If the remote start procedure is used again before the first 10-minute time frame has ended, the first 10 minutes will immediately expire and the second 10-minute time frame will start.

For example, if  and then  are pressed again after the vehicle has been running for five minutes,

10 minutes are added, allowing the engine to run for a total of 15 minutes.

A maximum of two remote starts or remote start attempts are allowed between ignition cycles.

After the vehicle's engine has been started two times using the remote start button, the ignition must be turned on and then back off before the remote start procedure can be used again.

Canceling a Remote Start

To manually shut off a remote start:

- Aim the RKE transmitter at the vehicle and press  until the parking lamps turn off.
- Turn on the hazard warning flashers.
- Turn the ignition switch on and then off.

2-6 Keys, Doors, and Windows

Conditions in Which the Remote Start Will Not Work

The vehicle cannot be started using the remote start feature if the key is in the ignition, the hood is open, or if there is an emission control system malfunction.

The engine turns off during a remote start if the coolant temperature gets too high or if the oil pressure gets low.

Door Locks

 **Warning**

Unlocked doors can be dangerous.

- Passengers, especially children, can easily open the doors and fall out of a moving vehicle. When a door is locked, the handle will not open it. The chance of being thrown out of the vehicle in a

(Continued)

Warning (Continued)

crash is increased if the doors are not locked. So, all passengers should wear safety belts properly and the doors should be locked whenever the vehicle is driven.

- Young children who get into unlocked vehicles may be unable to get out. A child can be overcome by extreme heat and can suffer permanent injuries or even death from heat stroke. Always lock the vehicle whenever leaving it.
- Outsiders can easily enter through an unlocked door when you slow down or stop the vehicle. Locking the doors can help prevent this from happening.

To lock or unlock a door manually:

- From the inside use the door lock knob on the window sill.
- From the outside turn the key toward the front or rear of the vehicle, or press the or button on the Remote Keyless Entry (RKE) transmitter.

Power Door Locks

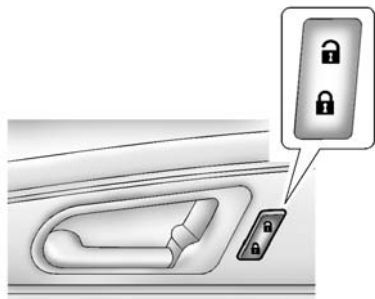

Base Model

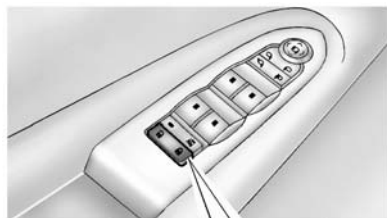

Uplevel Model

 (Unlock): Press to unlock the doors.



 (Lock): Press to lock the doors.

Delayed Locking

This feature delays the locking of the doors until five seconds after all doors are closed.

When  is pressed on the power door lock switch while the door or liftgate is open, a chime will sound three times indicating delayed locking is active.

The doors will lock automatically five seconds after all doors are closed. If a door is reopened before that time, the five-second timer will reset when all doors are closed again.

Press  on the door lock switch again or press  on the RKE transmitter to lock doors immediately.

This feature can also be programmed. See *Vehicle Personalization (With DIC Buttons)* on page 5-45.

Automatic Door Locks

The doors will lock automatically when all doors are closed, the ignition is on, and the shift lever is moved out of P (Park).

To unlock the doors:

- Press  on a door.
- Shift the transmission into P (Park).

Automatic door unlocking can be programmed through the Driver Information Center (DIC). See *Vehicle Personalization (With DIC Buttons)* on page 5-45.

Lockout Protection

When locking is requested with the driver door open and the key in the ignition, all the doors will lock and then the driver door will unlock.

2-8 Keys, Doors, and Windows

This can be manually overridden by pressing and holding  on the power door lock switch.

If Unlocked Door Anti-Lockout is turned on, the vehicle is off with the driver door open, and door locking is requested, all the doors will lock and only the driver door will unlock. The Unlocked Door Anti-Lockout feature can be turned on or off using the vehicle personalization menus. See *Vehicle Personalization (With DIC Buttons)* on page 5-45.

Safety Locks

Caution

Pulling the inside door handle while the rear door safety locks are engaged could damage your vehicle. Do not pull the inside door handle while the rear door safety locks are engaged.

The vehicle has rear door security locks to prevent passengers from opening the rear doors from the inside.

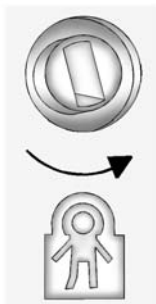

Open the rear doors to access the security locks on the inside edge of each door.

To set the locks, insert a key into the slot and turn it to the horizontal position. The door can only be opened from the outside with the door unlocked. To return the door to normal operation, turn the slot to the vertical position.

Doors

Liftgate

Warning

Exhaust gases can enter the vehicle if it is driven with the liftgate or trunk/hatch open, or with any objects that pass through the seal between the body and the trunk/hatch or liftgate. Engine exhaust contains carbon monoxide (CO) which cannot be seen or smelled. It can cause unconsciousness and even death.

If the vehicle must be driven with the liftgate or trunk/hatch open:

- Close all of the windows.
- Fully open the air outlets on or under the instrument panel.

(Continued)

Warning (Continued)

- Adjust the climate control system to a setting that brings in only outside air and set the fan speed to the highest setting. See “Climate Control Systems” in the Index.
- If the vehicle is equipped with a power liftgate, disable the power liftgate function.

See *Engine Exhaust* on page 9-21.

 **Caution**

To avoid damage to the liftgate or liftgate glass, make sure the area above and behind the liftgate is clear before opening it.

Manual Liftgate

To unlock the liftgate, press the power door lock switch or press  on the Remote Keyless Entry (RKE) transmitter twice. See *Remote Keyless Entry (RKE) System Operation* on page 2-2.

To open the liftgate, press the touch pad under the liftgate handle and lift up. The vehicle must be in P (Park) and the battery must be charged. Use the pull cup or pull strap to lower and close the liftgate.

Always close the liftgate before driving.

Power Liftgate

If equipped with a power liftgate, the vehicle must be in P (Park) to operate. The taillamps flash and a chime sounds when the power liftgate moves.

 **Warning**

You, or others, could be injured if caught in the path of the power liftgate. Make sure there is no one in the way of the liftgate as it is opening and closing.

The power liftgate can be power opened and closed in the following ways:

- Press and hold  on the RKE transmitter. See *Remote Keyless Entry (RKE) System Operation* on page 2-2.

2-10 Keys, Doors, and Windows

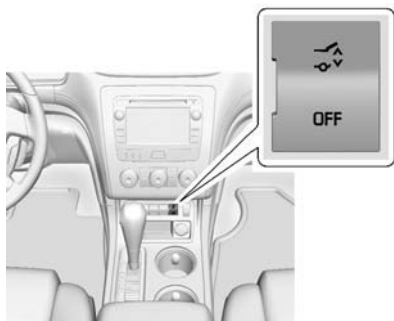

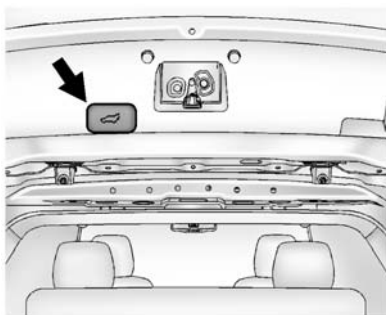

- Press .
- Press the touch pad on the outside liftgate handle.

Pressing the buttons or touch pad a second time while the liftgate is moving reverses the direction.



Power Liftgate Touch Pad

The liftgate can also be closed by pressing  next to the liftgate latch. Press  a second time during the liftgate operation to reverse the operation.

The power liftgate may be temporarily disabled under extreme temperatures or under low battery conditions. If this occurs, the liftgate can be operated manually.

If the vehicle is shifted out of P (Park) while the liftgate power function is in progress, it will

continue to completion. If the vehicle is shifted out of P (Park) and accelerated before the power liftgate latch closes, the liftgate may reverse to the open position. Cargo could fall out of the vehicle. Always make sure the power liftgate is closed and latched before driving away.

If the power liftgate is used and the liftgate support struts have lost pressure, the taillamps will flash and a chime will sound. The liftgate will stay open temporarily, and then slowly close. See your dealer for service before using the liftgate if this occurs.

Obstacle Detection Features

If an obstacle is encountered during the power open or close cycle, a warning chime will sound and the liftgate will automatically reverse the direction to the full closed or open position. After removing the obstacle the liftgate will resume normal operation.

If more obstacles are encountered on the same power cycle, the power function deactivates. The liftgate must be opened or closed manually if this occurs. A message displays on the Driver Information Center (DIC) to indicate that the liftgate is open. See *Door Ajar Messages on page 5-35*. After removing the obstacles, manually open the liftgate fully or close and latch the liftgate. The liftgate will resume normal power operation.

The vehicle also has pinch sensors along the side edges of the liftgate. If the sensors press against an object while closing, the liftgate will reverse direction and open fully. The liftgate will remain open until it is activated again or closed manually.

Do not force the liftgate open or closed during a power cycle.

Manual Operation of Power Liftgate





To change the liftgate to manual operation, press OFF on the power liftgate switch. A message displays on the DIC indicating manual operation mode. See *Door Ajar Messages on page 5-35*.

With the liftgate in manual mode and all of the doors unlocked, the liftgate can be manually opened and closed.

Press the touch pad on the outside of the liftgate pull cup and lift to open. Use the pull cup to lower and close the liftgate. The liftgate latch will power close.

Always close the liftgate before driving.

If  on the RKE transmitter or  on the liftgate is pressed while in manual operation mode, the taillamps will flash three times, but the liftgate will not move.

It is not recommended to drive with the liftgate open. However, if the vehicle must be driven with the liftgate open, the liftgate should be set to manual operation.

Vehicle Security

This vehicle has theft-deterrent features; however, they do not make the vehicle impossible to steal.

Vehicle Alarm System

On vehicles with an anti-theft alarm system, to activate the system:

- Press  on the Remote Keyless Entry (RKE) transmitter or the power door lock switch when any door is open.



The security light flashes.

When the door is closed, the security light stops flashing and stays on solid for approximately 30 seconds. The content theft-deterrent alarm is not armed until the security light goes off.

If the delayed locking feature is active, the alarm is not activated until all doors are closed and the security light goes off.

- Press  when the driver door is closed. The security light comes on solid for approximately 30 seconds and then goes off. The content theft-deterrent alarm is not armed until the security light goes off.

The theft-deterrent system will not activate if the doors are locked with the vehicle's key or the manual door lock.

If a locked door is opened without using the RKE transmitter, a 10-second pre-alarm occurs. The

horn chirps and the lights flash.

If the key is not placed in the ignition and turned to START or the door is not unlocked by pressing  during the 10-second pre-alarm, the alarm goes off. The headlamps flash and the horn sounds for about 30 seconds, then turns off to save the battery power.

The vehicle can be started with the correct ignition key if the alarm has been set off.

To avoid setting off the alarm by accident:

- Lock the vehicle with the door key after the doors are closed.
- Unlock the door with the RKE transmitter. Unlocking a door any other way sets off the alarm if the system has been armed.

Press  or place the key in the ignition and turn it to START to turn off the alarm.

Testing the Alarm

To test the alarm:

1. From inside the vehicle, lower the driver side window, and open the driver door.
2. Press .
3. Get out of the vehicle, close the door, and wait for the security light to go out.
4. Reach in through the window, unlock the door with the manual door lock, and open the door. This should set off the alarm.

If the alarm does not sound when it should, but the headlamps flash, check to see if the horn works. The horn fuse may be blown. To replace the fuse, see *Fuses and Circuit Breakers on page 10-29*.

If the alarm does not sound or the headlamps do not flash, see your dealer for service.

Immobilizer

See *Radio Frequency Statement on page 13-12*.

Immobilizer Operation

This vehicle has PASS-Key[®] III+ (Personalized Automotive Security System) theft-deterrent system. PASS-Key III+ is a passive theft-deterrent system.

The system is automatically armed when the key is removed from the ignition.

The system is automatically disarmed when the key is turned to ON/RUN, ACC/ACCESSORY, or START from the LOCK/OFF position.

You do not have to manually arm or disarm the system.

The security light comes on if there is a problem with arming or disarming the theft-deterrent system.

When the PASS-Key III+ system senses an incorrect key, the vehicle does not start. Anyone using a trial-and-error method to start the vehicle will be discouraged because of the high number of electrical key codes.

If the engine does not start and the security light on the instrument panel comes on when trying to start the vehicle, there may be a problem with the theft-deterrent system. Turn the ignition off and try again.

If the engine still does not start, and the key appears to be undamaged, try another ignition key and check the fuses. See *Fuses and Circuit Breakers on page 10-29* for additional information. If the engine still does not start with the other key, the vehicle needs service. If the vehicle does start, the first key may be faulty. See your dealer who can service the PASS-Key III+ to have a new key made. In an emergency, contact Roadside Assistance. See *Roadside Assistance Program on page 13-5*.

2-14 Keys, Doors, and Windows

It is possible for the PASS-Key III+ decoder to learn the transponder value of a new or replacement key. Up to 10 keys may be programmed to the vehicle. The following procedure is for programming additional keys only. If all currently programmed keys are lost or do not operate, you must see your dealer or a locksmith who can service PASS-Key III+ to have keys made and programmed to the system.

See your dealer or a locksmith who can service PASS-Key III+ to get a new key blank that is cut exactly as the ignition key that operates the system.

To program the new additional key:

1. Verify that the new key has a ⊕ stamped on it.
2. Insert the already programmed key in the ignition and start the engine. If the engine does not start, see your dealer for service.

3. After the engine has started, turn the key to LOCK/OFF, and remove the key.
4. Insert the key to be programmed and turn it to the ON/RUN position within five seconds of the original key being turned to the LOCK/OFF position.

The security light turns off once the key has been programmed.
5. Repeat Steps 1–4 if additional keys are to be programmed.

If the PASS-Key III+ key is lost or damaged, see your dealer or a locksmith to have a new key made.

The SERVICE THEFT DETERRENT SYSTEM message displays on the Driver Information Center (DIC) when there is a problem with the theft-deterrent system. See *Security Messages on page 5-41* for additional information.

Do not leave the key or device that disarms or deactivates the theft-deterrent system in the vehicle.

Exterior Mirrors

Convex Mirrors



A convex mirror can make things, like other vehicles, look farther away than they really are. If you cut too sharply into the right lane, you could hit a vehicle on the right. Check the inside mirror or glance over your shoulder before changing lanes.

The passenger side mirror is convex shaped. A convex mirror's surface is curved so more can be seen from the driver seat.

Power Mirrors



Base Model

To adjust the mirrors:

1. Press ◀ or ▶ to select a mirror.
2. Press the control pad to adjust the mirror.
3. Return the switch to the center to deselect the mirror.

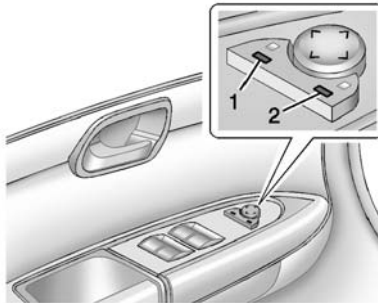

Uplevel Model

To adjust the mirrors:

1. Press (1) or (2) to select a mirror.
2. Press the control pad to adjust the mirror.
3. Press (1) or (2) again to deselect the mirror.

Side Blind Zone Alert (SBZA)

If the vehicle has the SBZA system, see *Side Blind Zone Alert (SBZA)* on page 9-36.

Folding Mirrors

For vehicles with manual folding mirrors, push the mirror toward the vehicle. Pull the mirror out to return to its original position.

For vehicles with power folding mirrors:

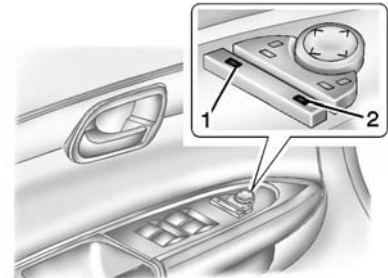

1. Press (1) to fold the mirrors out to the driving position.
2. Press (2) to fold the mirrors in to the folded position.

Resetting the Power Folding Mirrors

Reset the power folding mirrors if:

- The mirrors are accidentally obstructed while folding.
- They are accidentally manually folded/unfolded.
- The mirrors vibrate at normal driving speeds.

To reset the mirrors, fold and unfold the mirrors one time using the power folding mirror controls.

A popping noise may be heard during the resetting. This sound is normal during the reset operation.

Heated Mirrors

For vehicles with heated mirrors:

 **(Rear Window Defogger):**

Press to heat the mirrors.

See “Rear Window Defogger” under *Dual Automatic Climate Control System* on page 8-4.

Park Tilt Mirrors

If equipped with memory seats, the passenger and/or driver mirror tilts to a preselected position when the vehicle is in R (Reverse). This allows the curb to be seen when parallel parking.

The mirror(s) return to the original position when:

- The vehicle is shifted out of R (Reverse), or remains in R (Reverse) for about 30 seconds.
- The ignition is turned off.
- The vehicle is driven in R (Reverse) above a set speed.

To turn this feature on or off, see *Vehicle Personalization (With DIC Buttons)* on page 5-45.

Interior Mirrors

Interior Rearview Mirrors

Adjust the rearview mirror for a clear view of the area behind your vehicle.

If equipped with OnStar, the vehicle may have three control buttons at the bottom of the mirror. See your dealer for more information about OnStar and how to subscribe to it. See “Onstar,” if equipped.

Do not spray glass cleaner directly on the mirror. Use a soft towel dampened with water.

Manual Rearview Mirror

If equipped, push the tab forward for daytime use and pull it for nighttime use to avoid glare from the headlamps from behind.

Automatic Dimming Rearview Mirror

If equipped, automatic dimming reduces the glare of the headlamps from behind. This feature comes on when the vehicle is started.

Windows

Warning

Never leave a child, a helpless adult, or a pet alone in a vehicle, especially with the windows closed in warm or hot weather. They can be overcome by the extreme heat and suffer permanent injuries or even death from heat stroke.



The vehicle aerodynamics are designed to improve fuel economy performance. This may result in a pulsing sound when either rear window is down and the front windows are up. To reduce the sound, open either a front window or the sunroof, if equipped.

Power Windows

Warning

Children could be seriously injured or killed if caught in the path of a closing window. Never leave keys in a vehicle with children. When there are children in the rear seat, use the window lockout button to prevent operation of the windows. See *Keys on page 2-1*.

2-18 Keys, Doors, and Windows



Uplevel Shown, Base Similar

The driver door has switches that control the passenger and rear windows. The power windows work with the ignition in ACC/ACCESSORY or ON/RUN or with Retained Accessory Power (RAP) active. See *Retained Accessory Power (RAP)* on page 9-18.

Press the switch to lower the window. Pull up on the front edge of the switch to raise the window.

Express-Up/Express-Down Windows

A window with the express-up/down feature allows it to be raised or lowered without holding the switch. Press or pull the window switch fully and release it to activate the express feature. The express mode can be canceled by pressing or pulling the switch.

Programming the Power Windows

If the vehicle battery has been recharged, disconnected, or replaced, windows with the express-up feature need to be reprogrammed for this feature to work. To program the window:

1. Close all doors with the ignition in the ACC/ACCESSORY or ON/RUN position, or with Retained Accessory Power (RAP) active. See *Retained Accessory Power (RAP)* on page 9-18.

2. Press and continue to hold the window switch until the window is fully open.
3. Pull up and hold the window switch to close the window. Continue to hold it briefly after the window is fully closed.
4. Repeat for each window that has the express-up feature.

Anti-Pinch Feature

The anti-pinch feature is on windows with the express-up feature. If an object is in the way of the window as it is express-closing, or in certain weather conditions like severe icing, the window will stop and open to a factory preset position. The window functions normally once the obstruction is removed.

Rear Window Lockout

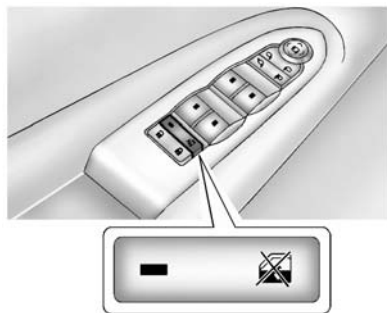

The rear window lockout feature prevents the rear passenger windows from operating, except from the driver position.

Press  to activate the rear window lockout switch. The indicator light comes on when activated.

Press  again to deactivate the lockout switch.

Sun Visors

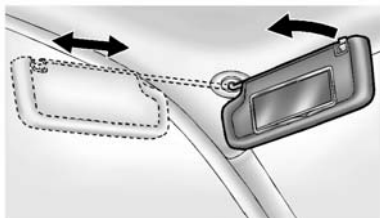

Pull the sun visor down to block glare. Detach the sun visor from the center mount to pivot to the side window or, if equipped, extend along the rod.

Roof

Sunroof

The ignition must be in ON/RUN or ACC/ACCESSORY, or Retained Accessory Power (RAP) must be active to operate the sunroof and power sunshade. See *Retained Accessory Power (RAP)* on page 9-18.

If equipped, there may be a rear sunroof over the second row seats. The rear sunroof does not open.

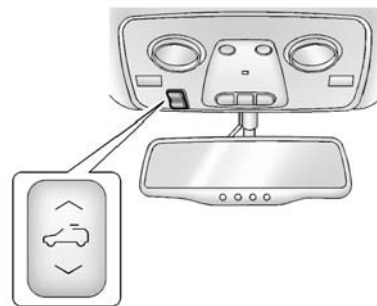

2-20 Keys, Doors, and Windows

Vent: Press and hold the front of the switch to vent the sunroof. Press and hold the rear of the switch to close the sunroof.

Express-open/Express-close:

Press and release the rear of the switch to express-open the sunroof. Press and release the front of the switch to express-close the sunroof.

Manual Sunshade

The sunshades must be opened and closed manually. To open the sunshade, press the button on the sunshade handle to release it and guide it back. To close the sunshade, pull the sunshade forward until it latches.

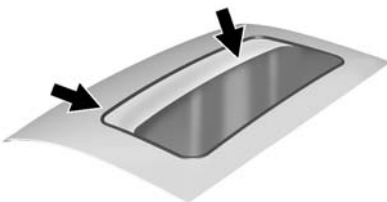

Dirt and debris may collect on the sunroof seal or in the track. This could cause an issue with sunroof operation or noise. It could also plug the water drainage system. Periodically open the sunroof and remove any obstacles or loose debris. Wipe the sunroof seal and roof sealing area using a clean cloth, mild soap, and water. Do not remove grease from the sunroof.

If water is seen dripping into the water drainage system, this is normal.

Seats and Restraints

Head Restraints

Head Restraints 3-2

Front Seats

Seat Adjustment 3-3
 Power Seat Adjustment 3-4
 Lumbar Adjustment 3-4
 Reclining Seatbacks 3-5
 Memory Seats 3-6
 Heated and Cooled Front
 Seats 3-8

Rear Seats

Rear Seats 3-9
 Third Row Seats 3-11

Safety Belts

Safety Belts 3-13
 How to Wear Safety Belts
 Properly 3-15

Lap-Shoulder Belt 3-16
 Safety Belt Use During
 Pregnancy 3-21
 Safety Belt Extender 3-21
 Safety System Check 3-21
 Safety Belt Care 3-22
 Replacing Safety Belt System
 Parts after a Crash 3-22

Airbag System

Airbag System 3-23
 Where Are the Airbags? 3-25
 When Should an Airbag
 Inflate? 3-27
 What Makes an Airbag
 Inflate? 3-28
 How Does an Airbag
 Restrain? 3-28
 What Will You See after an
 Airbag Inflates? 3-28
 Passenger Sensing
 System 3-30
 Servicing the Airbag-Equipped
 Vehicle 3-34

Adding Equipment to the
 Airbag-Equipped Vehicle ... 3-35
 Airbag System Check 3-35
 Replacing Airbag System
 Parts after a Crash 3-36

Child Restraints

Older Children 3-36
 Infants and Young
 Children 3-38
 Child Restraint Systems 3-41
 Where to Put the Restraint ... 3-43
 Lower Anchors and Tethers
 for Children (LATCH
 System) 3-44
 Replacing LATCH System
 Parts After a Crash 3-51
 Securing Child Restraints
 (Rear Seat) 3-51
 Securing Child Restraints
 (Front Passenger Seat) 3-53

Head Restraints

Front Seats

 **Warning**

With head restraints that are not installed and adjusted properly, there is a greater chance that occupants will suffer a neck/spinal injury in a crash. Do not drive until the head restraints for all occupants are installed and adjusted properly.

The vehicle's front seats have adjustable head restraints in the outboard seating positions.



Adjust the head restraint so that the top of the restraint is at the same height as the top of the occupant's head. This position reduces the chance of a neck injury in a crash.

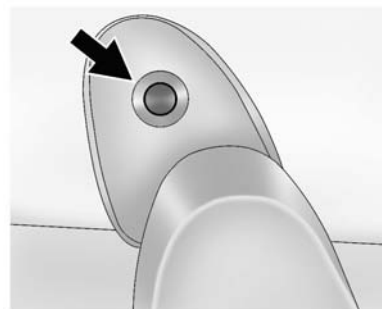

To raise or lower the head restraint, press the button located on the side of the head restraint, and pull up or push the head restraint down, and release the button. Pull and push on the head restraint after the button is released to make sure that it is locked in place.

To adjust the head restraint forward, grasp the head restraint and pull forward until the desired locking position is reached.

To adjust the head restraint rearward, press the button located on the side of the head restraint,

and push the head restraint rearward until the desired locking position is reached. Try to move the head restraint after the button is released to make sure that it is locked in place.

The front seat outboard head restraints are not removable.

Rear Seats

The vehicle's second row seats have head restraints in the outboard seating positions that cannot be adjusted.

The vehicle's third row seats have headrests in the outboard seating positions that cannot be adjusted.

The second row head restraints and third row headrests are not removable.

Front Seats

Seat Adjustment

Warning

You can lose control of the vehicle if you try to adjust a driver seat while the vehicle is moving. Adjust the driver seat only when the vehicle is not moving.

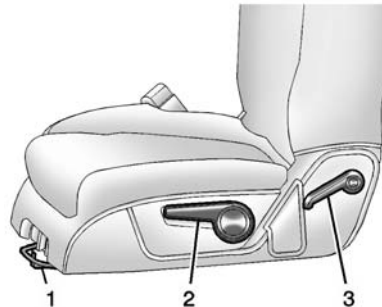

1. Seat Adjustment Handle

2. Driver Seat Height Adjustment Lever
3. Seatback Lever

To adjust a manual seat:

1. Lift the handle (1) under the seat to unlock it.
2. Slide the seat to the desired position, and then release the handle (1).
3. Try to move the seat back and forth to be sure it is locked in place.

Move the lever (2) up or down to raise or lower the seat.

Use the lever (3) to adjust the seatback. See *Reclining Seatbacks* on page 3-5.

3-4 Seats and Restraints

Power Seat Adjustment

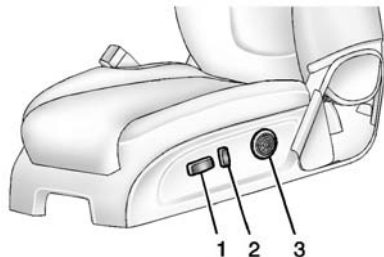

1. Seat Adjustment Control
2. Seatback Control
3. Lumbar Control

To adjust a power seat, if equipped:

- Move the seat forward or rearward by sliding the control (1) forward or rearward.
- Raise or lower the front part of the seat cushion by moving the front of the control (1) up or down.

- Raise or lower the entire seat by moving the rear of the control (1) up or down.
- Adjust the seatback by tilting the top of the control (2) forward or rearward.

See *Reclining Seatbacks* on page 3-5.

- Increase or decrease lumbar support by pressing the front or rear of the control (3).

See *Lumbar Adjustment* on page 3-4.

Lumbar Adjustment

Manual Lumbar

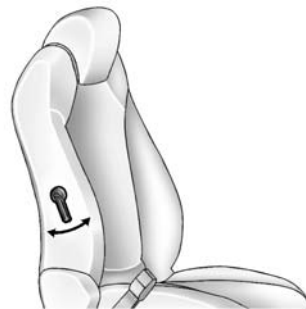

If equipped, move the handle forward or rearward to increase or decrease lumbar support.

Power Lumbar

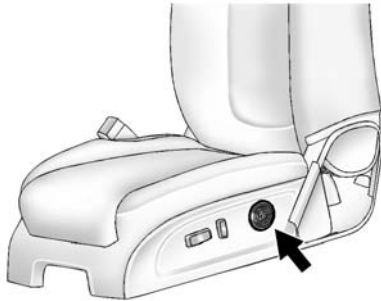

If equipped, press and hold the front or rear of control to increase or decrease lumbar support. Release the control when the seatback reaches the desired level of lumbar support.

Reclining Seatbacks

Warning

Sitting in a reclined position when the vehicle is in motion can be dangerous. Even when buckled up, the safety belts cannot do their job.

The shoulder belt will not be against your body. Instead, it will be in front of you. In a crash, you could go into it, receiving neck or other injuries.

The lap belt could go up over your abdomen. The belt forces would be there, not at your pelvic bones. This could cause serious internal injuries.

For proper protection when the vehicle is in motion, have the seatback upright. Then sit well back in the seat and wear the safety belt properly.



Do not have a seatback reclined if the vehicle is moving.

Manual Reclining Seatbacks

Warning

If either seatback is not locked, it could move forward in a sudden stop or crash. That could cause injury to the person sitting there. Always push and pull on the seatbacks to be sure they are locked.

3-6 Seats and Restraints

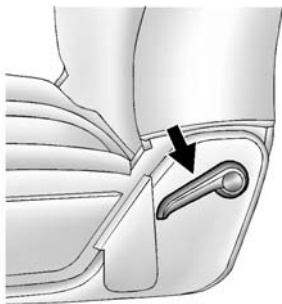

To recline the seatback:

1. Lift the lever.
2. Move the seatback to the desired position, and then release the lever to lock the seatback in place.
3. Push and pull on the seatback to make sure it is locked.

To return the seatback to the upright position:

1. Lift the lever fully without applying pressure to the seatback, and the seatback will return to the upright position.

2. Push and pull on the seatback to make sure it is locked.

Power Reclining Seatbacks

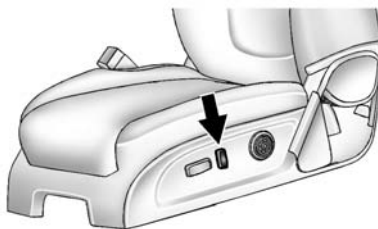

To adjust a power seatback, if equipped:

- Tilt the top of the control rearward to recline.
- Tilt the top of the control forward to raise.

Memory Seats

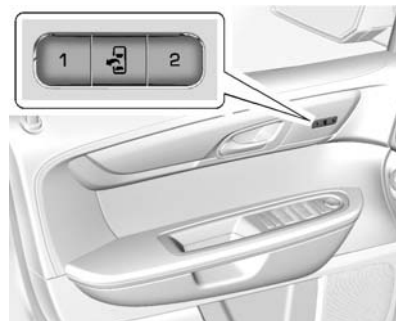

If equipped, the controls on the driver door are used to program and recall memory settings for the driver seat and outside mirrors.

Storing Memory Positions

To save into memory:

1. Adjust the driver seat, seatback recliner, and both outside mirrors.

Not all vehicles will have the ability to save and recall the mirror positions.

2. Press and hold “1” until two beeps sound.
3. Repeat for a second driver position using “2.”

To recall, press and release “1” or “2.” The vehicle must be in P (Park). A single beep will sound. The seat and outside mirrors will move to the position previously stored for the identified driver.

Memory Remote Recall

The memory feature can recall the driver seat and outside mirrors to stored positions when entering the vehicle.

To activate, unlock the driver door with the Remote Keyless Entry (RKE) transmitter. The driver seat and outside mirrors will move to the memory position associated with the transmitter used to unlock the vehicle.

This feature is turned on or off using the vehicle personalization menu. See *Vehicle Personalization (With DIC Buttons)* on page 5-45.

To stop recall movement, press one of the power seat controls, memory buttons, or the power mirror buttons.

If something has blocked the driver seat while recalling a memory position, the recall may stop. Remove the obstruction; then press and hold the appropriate manual control for the memory item that is not recalling for two seconds. Try recalling the memory position again by pressing the appropriate memory button. If the memory position is still not recalling, see your dealer for service.

Easy Exit Driver Seat

This feature can move the seat rearward to allow extra room to exit the vehicle.

 **(Easy Exit Driver Seat):** Press to activate the recall. The vehicle must be in P (Park).

If this feature is programmed on in the vehicle personalization menu, automatic seat movement occurs when the ignition key is removed.

A single beep sounds. The driver seat moves back approximately 8 cm (3 in). To move the seat back farther, press  again until the seat is all the way back.

If something has blocked the driver seat while recalling the exit position, the recall may stop. Remove the obstruction; then press and hold the power seat control rearward for two seconds. Try recalling the exit position again. If the exit position is still not recalling, see your dealer for service.

See *Vehicle Personalization (With DIC Buttons)* on page 5-45.

3-8 Seats and Restraints

Heated and Cooled Front Seats

Warning

If you cannot feel temperature change or pain to the skin, the seat heater may cause burns. To reduce the risk of burns, people with such a condition should use care when using the seat heater, especially for long periods of time. Do not place anything on the seat that insulates against heat, such as a blanket, cushion, cover, or similar item. This may cause the seat heater to overheat. An overheated seat heater may cause a burn or may damage the seat.



Heated and Cooled Seat Buttons Shown, Heated Seat Buttons Similar

If equipped, the buttons are on the center stack. To operate, the engine must be running.

 **(Heated Seatback):** If equipped, press to heat the seatback only.

 **(Cooled Seat):** If equipped, press to cool the entire seat.

 **(Heated Seat and Seatback):** Press to heat the seat and seatback.

Press the button once for the highest setting. With each press of the button, the seat will change to the next lower setting, and then to

the off setting. The lights indicate three for the highest setting and one for the lowest.

The passenger heated seat may take longer to heat up.

The heated and/or cooled seats are canceled after the ignition is turned off.

Remote Start Heated Seats

When it is cold outside, the heated seats may turn on automatically during a remote vehicle start. The heated seats will be canceled when the ignition is turned on. Press the desired heated seat button to use the heated seats after the vehicle is started.

The heated seat button lights will not turn on during a remote start.

The temperature of an unoccupied seat may be reduced.

See *Remote Vehicle Start* on page 2-4.

Rear Seats



1. Seat Adjustment Handle
2. Reclining Seatback Strap
3. Sliding Seat Lever

Entering and Exiting the Third Row

Warning

Using the third row seating position while the second row is folded, or folded and tumbled, could cause injury in a sudden stop or crash. Be sure to return the seat to the passenger seating position. Push and pull on the seat to make sure it is locked into place.

Caution

Folding a rear seat with the safety belts still fastened may cause damage to the seat or the safety belts. Always unbuckle the safety belts and return them to their normal stowed position before folding a rear seat.

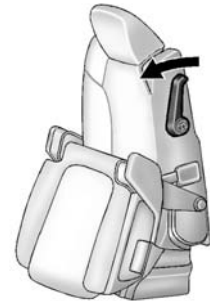

To access the third row:

1. Remove objects on the floor in front of or on the second row seat, or in the seat tracks on the floor.
2. Move the front center console armrest completely forward. See *Center Console Storage* on page 4-2.
3. Place the folding armrests in the upright position.
4. Make sure that the safety belt is unfastened and in the stowed position.

3-10 Seats and Restraints

5. Pull the sliding seat lever (3) forward. The seatback will tilt forward, and the seat will begin sliding forward. Continue to push forward on the seatback until the entire seat moves all the way forward and the seat cushion is folded.

Returning the Seat to the Seating Position

To return the second row seat to its normal seating position:

1. Remove objects on the floor behind the second row seat or in the seat tracks on the floor.
2. Slide the seat rearward by pushing on the seatback until the seat is locked into place.
3. Continue pushing the seatback rearward until the seatback is locked into place.
4. Push down on the rear of the seat cushion until it is locked in place.

5. Push and pull on the seatback and seat cushion to make sure they are locked in place.
6. Check that the safety belt is not under the seat cushion.

Reclining the Seatbacks

To recline the seatback:

1. Leaning rearward in the seat, pull the reclining seatback strap (2).
2. Move the seatback to the desired position, and then release the strap (2) to lock the seatback in place.
3. Push and pull on the seatback to make sure it is locked.

Folding the Seatback

To fold the second row seatbacks:

1. Remove anything on or under the seat.
2. Place the armrest in the upright position, and unfasten the safety belt.

3. Pull forward on the reclining seatback strap (2).

The head restraint will fold down automatically.

To return the seatback to the seating position, lift the seatback and push it rearward until it locks into place. Push and pull on the seatback to make sure it is locked. Pull up on the head restraint to return it to the upright, locked position.

Adjusting the Seats

To adjust the second row seats, pull outward on the seat adjustment handle (1). Slide the seat forward or rearward to the desired position. Release the handle (1), and push and pull on the seat to make sure it is locked.

Third Row Seats

Warning

Using the third row seating position while the second row is folded, or pushed forward in the entry position, could cause injury in a sudden stop or crash. Be sure to return the seat to the passenger seating position. Push and pull on the seat to make sure it is locked into place.

Folding the Seatback

Caution

Folding a rear seat with the safety belts still fastened may cause damage to the seat or the safety belts. Always unbuckle the safety belts and return them to their normal stowed position before folding a rear seat.

To fold the third row seatback:

1. If the second row seat is in the full rear position, adjust it forward to allow the third row seat to fold fully flat.
2. Remove anything on or under the seat.

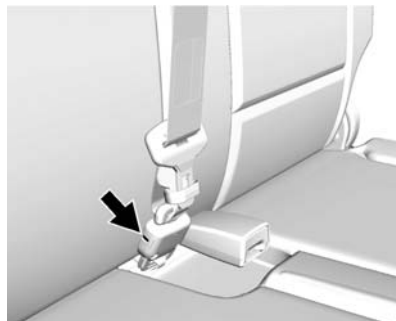

3. Disconnect the rear safety belt mini-latch, using a key in the slot on the mini-buckle, and let the belt retract into the headliner. Stow the mini-latch in the holder in the headliner.



4. Pull up on the release lever on the back of the seat.
5. Push the seatback forward to lay flat.

Returning the Seat to the Seating Position

To return the seatback to the seating position:

1. From the rear of the vehicle, raise the seatback to the upright position using the pull strap on the back of the third row seat,

3-12 Seats and Restraints

or lift the seatback and push it into place from inside the vehicle.

Warning

If either seatback is not locked, it could move forward in a sudden stop or crash. That could cause injury to the person sitting there. Always push and pull on the seatbacks to be sure they are locked.

2. Push and pull on the seatback to make sure it is locked in place.

Warning

A safety belt that is improperly routed, not properly attached, or twisted will not provide the protection needed in a crash. The person wearing the belt could be seriously injured. After raising the rear seatback, always check to be

(Continued)

Warning (Continued)

sure that the safety belts are properly routed and attached, and are not twisted.

3. Reconnect the center safety belt mini-latch to the mini-buckle. Do not let it twist.
4. Pull on the safety belt to be sure the mini-latch is secure.

Removing the Third Row Seats

To remove a third row seat:

1. Remove the cargo management system, if it is installed. See *Cargo Management System on page 4-3*.
2. Remove anything on or under the seat.

Caution

Folding a rear seat with the safety belts still fastened may cause damage to the seat or the safety belts. Always unbuckle the safety belts and return them to their normal stowed position before folding a rear seat.

3. Fold the seatback down. See "Folding the Seatback" earlier in this section.
4. Remove the rear bolts on the floor on each side of the seat.
5. Remove the seat by tilting it slightly upward, and then pulling it out of the rear of the vehicle in one motion.
6. Replace the bolts in the floor holes for storage.

Installing the Third Row Seats

To reinstall a third row seat:

1. Before installing the seat, the seatback must be folded forward. See “Folding the Seatback” earlier in this section.

The seats must be placed in the proper locations to attach correctly. The wider seat must be installed on the driver side and the narrower seat on the passenger side. Remove the bolts from the holes in the floor before installing the seats.

2. Place the seat on the vehicle floor so that the front seat hooks are on the vehicle bars.
3. Reinstall the bolts, and torque to 55 N•m (41 lb ft). Pull up on the seat to make sure it is locked in place.
4. Raise the seatback to its upright position. Push and pull on the seatback to make sure it is locked into place.
5. Reconnect the center safety belt mini-latch to the mini-buckle. Do not let it twist.

Safety Belts

This section of the manual describes how to use safety belts properly. It also describes some things not to do with safety belts.

Warning

Do not let anyone ride where a safety belt cannot be worn properly. In a crash, if you or your passenger(s) are not wearing safety belts, injuries can be much worse than if you are wearing safety belts. You can be seriously injured or killed by hitting things inside the vehicle harder or by being ejected from the vehicle. In addition, anyone who is not buckled up can strike other passengers in the vehicle.

It is extremely dangerous to ride in a cargo area, inside or outside of a vehicle. In a collision, passengers riding in these areas

(Continued)

3-14 Seats and Restraints

Warning (Continued)

are more likely to be seriously injured or killed. Do not allow passengers to ride in any area of the vehicle that is not equipped with seats and safety belts.

Always wear a safety belt, and check that all passenger(s) are restrained properly too.

This vehicle has indicators as a reminder to buckle the safety belts. See *Safety Belt Reminders* on page 5-15.

Why Safety Belts Work



When riding in a vehicle, you travel as fast as the vehicle does. If the vehicle stops suddenly, you keep going until something stops you. It could be the windshield, the instrument panel, or the safety belts!

When you wear a safety belt, you and the vehicle slow down together. There is more time to stop because you stop over a longer distance and, when worn properly, your strongest bones take the forces from the

safety belts. That is why wearing safety belts makes such good sense.

Questions and Answers About Safety Belts

Q: Will I be trapped in the vehicle after a crash if I am wearing a safety belt?

A: You *could* be — whether you are wearing a safety belt or not. Your chance of being conscious during and after a crash, so you *can* unbuckle and get out, is *much* greater if you are belted.

Q: If my vehicle has airbags, why should I have to wear safety belts?

A: Airbags are supplemental systems only; so they work *with* safety belts — not instead of them. Whether or not an airbag is provided, all occupants still have to buckle up to get the most protection.

Also, in nearly all states and in all Canadian provinces, the law requires wearing safety belts.

How to Wear Safety Belts Properly

This section is only for people of adult size.

There are special things to know about safety belts and children. And there are different rules for smaller children and infants. If a child will be riding in the vehicle, see *Older Children on page 3-36* or *Infants and Young Children on page 3-38*. Follow those rules for everyone's protection.

It is very important for all occupants to buckle up. Statistics show that unbelted people are hurt more often in crashes than those who are wearing safety belts.

There are important things to know about wearing a safety belt properly.

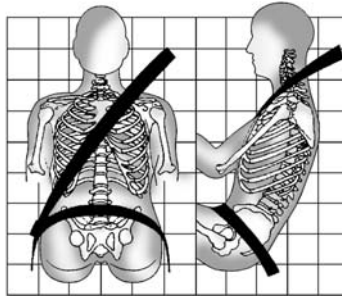

- Sit up straight and always keep your feet on the floor in front of you.
- Always use the correct buckle for your seating position.
- Wear the lap part of the belt low and snug on the hips, just touching the thighs. In a crash, this applies force to the strong pelvic bones and you would be less likely to slide under the lap belt. If you slid under it, the belt

would apply force on your abdomen. This could cause serious or even fatal injuries.

- Wear the shoulder belt over the shoulder and across the chest. These parts of the body are best able to take belt restraining forces. The shoulder belt locks if there is a sudden stop or crash.

Warning

You can be seriously injured, or even killed, by not wearing your safety belt properly.

- Never allow the lap or shoulder belt to become loose or twisted.
- Never wear the shoulder belt under both arms or behind your back.
- Never route the lap or shoulder belt over an armrest.

Lap-Shoulder Belt

All seating positions in the vehicle have a lap-shoulder belt.

If you are using a rear seating position with a detachable safety belt and the safety belt is not attached, see “Returning the Seat to the Seating Position” under *Third Row Seats* on page 3-11 for instruction on reconnecting the safety belt to the mini-buckle.

The following instructions explain how to wear a lap-shoulder belt properly.

1. Adjust the seat, if the seat is adjustable, so you can sit up straight. To see how, see “Seats” in the Index.

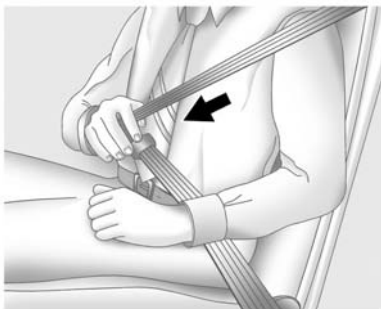

2. Pick up the latch plate and pull the belt across you. Do not let it get twisted.

The lap-shoulder belt may lock if you pull the belt across you very quickly. If this happens, let the belt go back slightly to unlock it. Then pull the belt across you more slowly.

If the shoulder portion of a passenger belt is pulled out all the way, the child restraint locking feature may be engaged. If this happens, let the belt go back all the way and start again.

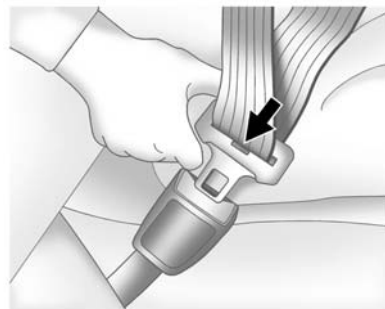

3. Push the latch plate into the buckle until it clicks.
4. Pull up on the latch plate to make sure it is secure. If the belt is not long enough, see *Safety Belt Extender* on page 3-21.

Position the release button on the buckle so that the safety belt could be quickly unbuckled if necessary.

5. If equipped with a shoulder belt height adjuster, move it to the height that is right for you. See “Shoulder Belt Height Adjuster”

later in this section for instructions on use and important safety information.

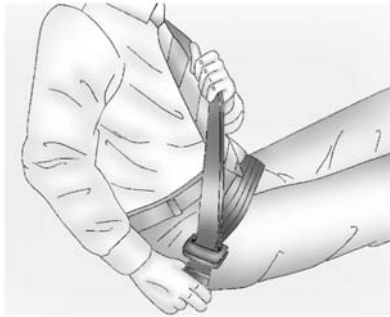

6. To make the lap part tight, pull up on the shoulder belt.

It may be necessary to pull the stitching on the safety belt through the latch plate to fully tighten the lap belt on smaller occupants.



To unlatch the belt, push the button on the buckle. The belt should return to its stowed position. Slide the latch plate up the safety belt webbing when the safety belt is not in use. The latch plate should rest on the stitching on the safety belt, near the guide loop on the side wall.

Before a door is closed, be sure the safety belt is out of the way. If a door is slammed against a safety belt, damage can occur to both the safety belt and the vehicle.

Shoulder Belt Height Adjuster

The vehicle has a shoulder belt height adjuster for the driver and right front passenger seating positions.

Adjust the height so the shoulder portion of the belt is on the shoulder but not falling off of it. The belt should be close to but not contacting the neck. Improper shoulder belt height adjustment could reduce the effectiveness of the safety belt in a crash. See *How to Wear Safety Belts Properly* on page 3-15.



To move it down, push down on the release button and move the height adjuster to the desired position. You can move the height adjuster up by pushing up on the shoulder belt guide.

After the adjuster is set to the desired position, try to move it down without pushing the release button to make sure it has locked into position.

Safety Belt Pretensioners

This vehicle has safety belt pretensioners for the front outboard occupants. Although the safety belt pretensioners cannot be seen, they are part of the safety belt assembly. They can help tighten the safety belts during the early stages of a moderate to severe frontal, near frontal, or rear crash if the threshold conditions for pretensioner activation are met. Safety belt pretensioners can also help tighten the safety belts in a side crash or a rollover event.

Pretensioners work only once. If the pretensioners activate in a crash, they will need to be replaced, and probably other new parts for the vehicle's safety belt system. See *Replacing Safety Belt System Parts after a Crash* on page 3-22.

Rear Safety Belt Comfort Guides

Rear safety belt comfort guides may provide added safety belt comfort for older children who have outgrown booster seats and for some adults. When installed on a shoulder belt and properly adjusted, the comfort guide positions the shoulder belt away from the neck and head.

Second Row Seats

There are comfort guides for the rear outboard seating positions in the second row stored on a clip on the interior trim next to the outboard seatback.

To install:



1. Remove the guide from its storage clip on the interior trim next to the outboard seatback.

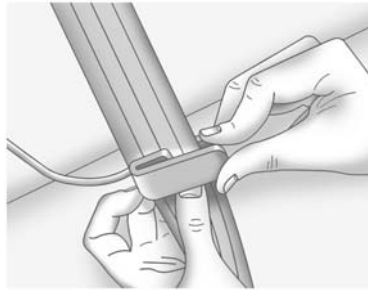

2. Place the guide over the belt, and insert the two edges of the belt into the slots of the guide.

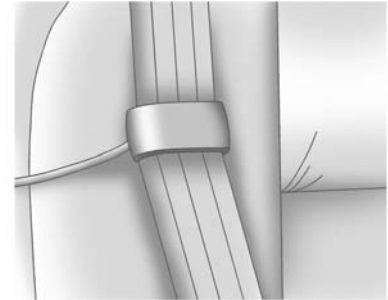

3. Be sure that the belt is not twisted and it lies flat. The elastic cord must be behind the belt with the plastic guide on the front.

Warning

A safety belt that is not properly worn may not provide the protection needed in a crash. The person wearing the belt could be seriously injured. The shoulder belt should go over the shoulder

(Continued)

3-20 Seats and Restraints

Warning (Continued)

and across the chest. These parts of the body are best able to take belt restraining forces.



4. Buckle, position, and release the safety belt as described previously in this section. Make sure the shoulder portion of the belt is on the shoulder and not falling off of it. The belt should be close to, but not contacting, the neck.

To remove and store the comfort guide, squeeze the belt edges together so that the safety belt can be removed from the guide. Slide the guide onto its storage clip.

Third Row Seats

Warning

A safety belt that is not properly worn may not provide the protection needed in a crash. The person wearing the belt could be seriously injured. The shoulder belt should go over the shoulder and across the chest. These parts of the body are best able to take belt restraining forces.

Comfort guides for the third row seating positions are available from your dealer. Instructions are included with the guide.

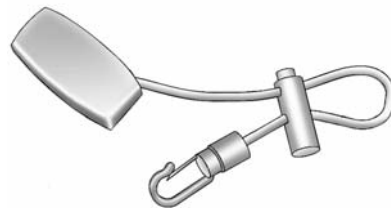

An adjustable comfort guide is used for the center seating position in the third row seat. The adjustable comfort guide attaches to a loop on the upper part of the seatback, behind the left outboard headrest.



For the third row outboard seating positions, the comfort guide, once installed, is a clip on the interior trim next to the outboard seatback.

Safety Belt Use During Pregnancy

Safety belts work for everyone, including pregnant women. Like all occupants, they are more likely to be seriously injured if they do not wear safety belts.



A pregnant woman should wear a lap-shoulder belt, and the lap portion should be worn as low as possible, below the rounding, throughout the pregnancy.

The best way to protect the fetus is to protect the mother. When a safety belt is worn properly, it is more likely that the fetus will not be hurt in a crash. For pregnant women, as for anyone, the key to making safety belts effective is wearing them properly.

Safety Belt Extender

If the vehicle's safety belt will fasten around you, you should use it.

But if a safety belt is not long enough, your dealer will order you an extender. When you go in to order it, take the heaviest coat you will wear, so the extender will be long enough for you. To help avoid personal injury, do not let someone else use it, and use it only for the seat it is made to fit. The extender has been designed for adults. Never

use it for securing child seats. To wear it, attach it to the regular safety belt. See the instruction sheet that comes with the extender.

Safety System Check

Now and then, check that the safety belt reminder light, safety belts, buckles, latch plates, retractors, and anchorages are all working properly. Look for any other loose or damaged safety belt system parts that might keep a safety belt system from doing its job. See your dealer to have it repaired. Torn or frayed safety belts may not protect you in a crash. They can rip apart under impact forces. If a belt is torn or frayed, get a new one right away.

Make sure the safety belt reminder light is working. See *Safety Belt Reminders on page 5-15*.

Keep safety belts clean and dry. See *Safety Belt Care on page 3-22*.

Safety Belt Care

Keep belts clean and dry.

 **Warning**

Do not bleach or dye safety belts. It may severely weaken them. In a crash, they might not be able to provide adequate protection. Clean safety belts only with mild soap and lukewarm water.

Replacing Safety Belt System Parts after a Crash

 **Warning**

A crash can damage the safety belt system in the vehicle. A damaged safety belt system may not properly protect the person using it, resulting in serious injury or even death in a crash. To help make sure the safety belt systems are working properly after a crash, have them inspected and any necessary replacements made as soon as possible.

After a minor crash, replacement of safety belts may not be necessary. But the safety belt assemblies that were used during any crash may have been stressed or damaged. See your dealer to have the safety belt assemblies inspected or replaced.

New parts and repairs may be necessary even if the safety belt system was not being used at the time of the crash.

Have the safety belt pretensioners checked if the vehicle has been in a crash, or if the airbag readiness light stays on after you start the vehicle or while you are driving. See *Airbag Readiness Light on page 5-16*.

Airbag System

The vehicle has the following airbags:

- A frontal airbag for the driver.
- A frontal airbag for the front outboard passenger.
- A seat-mounted side impact airbag for the driver.
- A seat-mounted side impact airbag for the front outboard passenger.
- A roof-rail airbag for the driver and for the second and third row passengers seated directly behind the driver.
- A roof-rail airbag for the front outboard passenger and the second and third row passengers seated directly behind the front outboard passenger.

The vehicle may have the following airbag:

- A front center airbag for the driver and front outboard passenger.

All vehicle airbags have the word AIRBAG on the trim or on an attached label near the deployment opening.

For frontal airbags, the word AIRBAG is on the center of the steering wheel for the driver and on the instrument panel for the front outboard passenger.

For the front center airbag, the word AIRBAG is on the inboard side of the driver seatback.

For seat-mounted side impact airbags, the word AIRBAG is on the side of the seatback closest to the door.

For roof-rail airbags, the word AIRBAG is on the ceiling or trim.

Airbags are designed to supplement the protection provided by safety belts. Even though today's airbags

are also designed to help reduce the risk of injury from the force of an inflating bag, all airbags must inflate very quickly to do their job.

Here are the most important things to know about the airbag system:

Warning

You can be severely injured or killed in a crash if you are not wearing your safety belt, even with airbags. Airbags are designed to work with safety belts, not replace them. Also, airbags are not designed to inflate in every crash. In some crashes safety belts are the only restraint. See *When Should an Airbag Inflate?* on page 3-27.

Wearing your safety belt during a crash helps reduce the chance of hitting things inside the vehicle or being ejected from it. Airbags are “supplemental restraints” to the

(Continued)

3-24 Seats and Restraints

Warning (Continued)

safety belts. Everyone in the vehicle should wear a safety belt properly, whether or not there is an airbag for that person.

Warning

Because airbags inflate with great force and faster than the blink of an eye, anyone who is up against, or very close to, any airbag when it inflates can be seriously injured or killed. Do not sit unnecessarily close to any airbag, as you would be if sitting on the edge of the seat or leaning forward. Safety belts help keep you in position before and during a crash. Always wear a safety belt, even with airbags. The driver

(Continued)

Warning (Continued)

should sit as far back as possible while still maintaining control of the vehicle.

Occupants should not lean on or sleep against the front center armrest or console in vehicles with a front center airbag.

Occupants should not lean on or sleep against the door or side windows in seating positions with seat-mounted side impact airbags and/or roof-rail airbags.

Warning

Children who are up against, or very close to, any airbag when it inflates can be seriously injured or killed. Always secure children properly in the vehicle. To read how, see *Older Children* on page 3-36 or *Infants and Young Children* on page 3-38.



There is an airbag readiness light on the instrument cluster, which shows the airbag symbol.

The system checks the airbag electrical system for malfunctions. The light tells you if there is an electrical problem. See *Airbag Readiness Light* on page 5-16 for more information.

Where Are the Airbags?



The driver frontal airbag is in the center of the steering wheel.



The front outboard passenger frontal airbag is in the passenger side instrument panel.



If the vehicle has a front center airbag, it is in the inboard side of the driver seatback.



Driver Side Shown, Passenger Side Similar

The driver and front outboard passenger seat-mounted side impact airbags are in the side of the seatbacks closest to the door.



Driver Side Shown, Passenger Side Similar

The roof-rail airbags for the driver, front outboard passenger, and second and third row outboard passengers are in the ceiling above the side windows.

Warning

If something is between an occupant and an airbag, the airbag might not inflate properly or it might force the object into

(Continued)

Warning (Continued)

that person causing severe injury or even death. The path of an inflating airbag must be kept clear. Do not put anything between an occupant and an airbag, and do not attach or put anything on the steering wheel hub or on or near any other airbag covering.

Do not use seat or console accessories that block the inflation path of a seat-mounted side impact airbag or the front center airbag, if equipped.

Never secure anything to the roof of a vehicle with roof-rail airbags by routing a rope or tie-down through any door or window opening. If you do, the path of an inflating roof-rail airbag will be blocked.

When Should an Airbag Inflate?

This vehicle is equipped with airbags. See *Airbag System on page 3-23*. Airbags are designed to inflate if the impact exceeds the specific airbag system's deployment threshold. Deployment thresholds are used to predict how severe a crash is likely to be in time for the airbags to inflate and help restrain the occupants. The vehicle has electronic sensors that help the airbag system determine the severity of the impact. Deployment thresholds can vary with specific vehicle design.

Frontal airbags are designed to inflate in moderate to severe frontal or near frontal crashes to help reduce the potential for severe injuries, mainly to the driver's or front outboard passenger's head and chest.

Whether the frontal airbags will or should inflate is not based primarily on how fast the vehicle is traveling.

It depends on what is hit, the direction of the impact, and how quickly the vehicle slows down.

Frontal airbags may inflate at different crash speeds depending on whether the vehicle hits an object straight on or at an angle, and whether the object is fixed or moving, rigid or deformable, narrow or wide.

Frontal airbags are not intended to inflate during vehicle rollovers, rear impacts, or many side impacts.

In addition, the vehicle has advanced technology frontal airbags. Advanced technology frontal airbags adjust the restraint according to crash severity.

The front center airbag, if equipped, is designed to inflate in moderate to severe side crashes depending upon the location of the impact, when either side of the vehicle is struck. In addition, the front center airbag is designed to inflate when the sensing system predicts that the vehicle is about to roll over on its

side. The front center airbag is not designed to inflate in frontal impacts, near frontal impacts, or rear impacts.

Seat-mounted side impact airbags are designed to inflate in moderate to severe side crashes depending on the location of the impact. Seat-mounted side impact airbags are not designed to inflate in frontal impacts, near frontal impacts, rollovers, or rear impacts.

A seat-mounted side impact airbag is designed to inflate on the side of the vehicle that is struck.

Roof-rail airbags are designed to inflate in moderate to severe side crashes depending on the location of the impact. In addition, these roof-rail airbags are designed to inflate during a rollover or in a severe frontal impact. Roof-rail airbags are not designed to inflate in rear impacts. Both roof-rail airbags will inflate when either side of the vehicle is struck, if the sensing

system predicts that the vehicle is about to roll over on its side, or in a severe frontal impact.

In any particular crash, no one can say whether an airbag should have inflated simply because of the vehicle damage or the repair costs.

What Makes an Airbag Inflate?

In a deployment event, the sensing system sends an electrical signal triggering a release of gas from the inflator. Gas from the inflator fills the airbag causing the bag to break out of the cover. The inflator, the airbag, and related hardware are all part of the airbag module.

For airbag locations, see *Where Are the Airbags?* on page 3-25.

How Does an Airbag Restrain?

In moderate to severe frontal or near frontal collisions, even belted occupants can contact the steering

wheel or the instrument panel. In moderate to severe side collisions, even belted occupants can contact the inside of the vehicle.

Airbags supplement the protection provided by safety belts by distributing the force of the impact more evenly over the occupant's body.

Rollover capable roof-rail airbags are also designed to help contain the head and chest of occupants in the outboard seating positions in the first, second, and third rows. The rollover capable roof-rail airbags are designed to help reduce the risk of full or partial ejection in rollover events, although no system can prevent all such ejections.

But airbags would not help in many types of collisions, primarily because the occupant's motion is not toward those airbags. See *When Should an Airbag Inflate?* on page 3-27 for more information.

Airbags should never be regarded as anything more than a supplement to safety belts.

What Will You See after an Airbag Inflates?

After the frontal airbags and seat-mounted side impact airbags inflate, they quickly deflate, so quickly that some people may not even realize an airbag inflated. The front center airbag, if equipped, and the roof-rail airbags may still be at least partially inflated for some time after they inflate. Some components of the airbag module may be hot for several minutes. For location of the airbags, see *Where Are the Airbags?* on page 3-25.

The parts of the airbag that come into contact with you may be warm, but not too hot to touch. There may be some smoke and dust coming from the vents in the deflated airbags. Airbag inflation does not prevent the driver from seeing out of

the windshield or being able to steer the vehicle, nor does it prevent people from leaving the vehicle.

 **Warning**

When an airbag inflates, there may be dust in the air. This dust could cause breathing problems for people with a history of asthma or other breathing trouble. To avoid this, everyone in the vehicle should get out as soon as it is safe to do so. If you have breathing problems but cannot get out of the vehicle after an airbag inflates, then get fresh air by opening a window or a door. If you experience breathing problems following an airbag deployment, you should seek medical attention.

The vehicle has a feature that may automatically unlock the doors, turn on the interior lamps and hazard warning flashers, and shut off the

fuel system after the airbags inflate. The feature may also activate, without airbag inflation, after an event that exceeds a predetermined threshold. You can lock the doors, and turn off the interior lamps and hazard warning flashers by using the controls for those features.

 **Warning**

A crash severe enough to inflate the airbags may have also damaged important functions in the vehicle, such as the fuel system, brake and steering systems, etc. Even if the vehicle appears to be drivable after a moderate crash, there may be concealed damage that could make it difficult to safely operate the vehicle.

Use caution if you should attempt to restart the engine after a crash has occurred.

In many crashes severe enough to inflate the airbag, windshields are broken by vehicle deformation. Additional windshield breakage may also occur from the front outboard passenger airbag.

- Airbags are designed to inflate only once. After an airbag inflates, you will need some new parts for the airbag system. If you do not get them, the airbag system will not be there to help protect you in another crash. A new system will include airbag modules and possibly other parts. The service manual for the vehicle covers the need to replace other parts.
- The vehicle has a crash sensing and diagnostic module which records information after a crash. See *Vehicle Data Recording and Privacy on page 13-14* and *Event Data Recorders on page 13-14*.

3-30 Seats and Restraints

- Let only qualified technicians work on the airbag systems. Improper service can mean that an airbag system will not work properly. See your dealer for service.

Passenger Sensing System

The vehicle has a passenger sensing system for the front outboard passenger position. The passenger airbag status indicator will light on the instrument panel when the vehicle is started.



United States



Canada and Mexico

The words ON and OFF, or the symbol for on and off, will be visible during the system check. When the system check is complete, either the word ON or OFF, or the symbol for on or off, will be visible. See *Passenger Airbag Status Indicator on page 5-17*.

The passenger sensing system turns off the front outboard passenger frontal airbag under certain conditions. No other airbag is affected by the passenger sensing system.

The passenger sensing system works with sensors that are part of the front outboard passenger seat. The sensors are designed to detect the presence of a properly-seated

occupant and determine if the front outboard passenger frontal airbag should be allowed to inflate or not.

According to accident statistics, children are safer when properly secured in a rear seat in the correct child restraint for their weight and size.

Whenever possible, children age 12 and under should be secured in a rear seating position.

Never put a rear-facing child seat in the front. This is because the risk to the rear-facing child is so great, if the airbag inflates.

Warning

A child in a rear-facing child restraint can be seriously injured or killed if the passenger frontal airbag inflates. This is because the back of the rear-facing child restraint would be very close to the inflating airbag. A child in a

(Continued)

Warning (Continued)

forward-facing child restraint can be seriously injured or killed if the passenger frontal airbag inflates and the passenger seat is in a forward position.

Even if the passenger sensing system has turned off the passenger frontal airbag, no system is fail-safe. No one can guarantee that an airbag will not inflate under some unusual circumstance, even though the airbag is off.

Secure rear-facing child restraints in a rear seat, even if the airbag is off. If you secure a forward-facing child restraint in the front outboard passenger seat, always move the seat as far back as it will go. It is better to secure the child restraint in a rear seat.

The passenger sensing system is designed to turn off the front outboard passenger frontal airbag if:

- The front outboard passenger seat is unoccupied.
- The system determines that an infant is present in a child restraint.
- A front outboard passenger takes his/her weight off of the seat for a period of time.
- There is a critical problem with the airbag system or the passenger sensing system.

When the passenger sensing system has turned off the front outboard passenger frontal airbag, the off indicator will light and stay lit as a reminder that the airbag is off. See *Passenger Airbag Status Indicator* on page 5-17.

The passenger sensing system is designed to turn on the front outboard passenger frontal airbag anytime the system senses that a person of adult size is sitting properly in the front outboard passenger seat.

When the passenger sensing system has allowed the airbag to be enabled, the on indicator will light and stay lit as a reminder that the airbag is active.

For some children, including children in child restraints, and for very small adults, the passenger sensing system may or may not turn off the front outboard passenger frontal airbag, depending upon the person's seating posture and body build. Everyone in the vehicle who has outgrown child restraints should wear a safety belt properly — whether or not there is an airbag for that person.

3-32 Seats and Restraints

Warning

If the airbag readiness light ever comes on and stays on, it means that something may be wrong with the airbag system. To help avoid injury to yourself or others, have the vehicle serviced right away. See *Airbag Readiness Light on page 5-16* for more information, including important safety information.

If the On Indicator Is Lit for a Child Restraint

The passenger sensing system is designed to turn off the front outboard passenger frontal airbag if the system determines that an infant is present in a child restraint. If a child restraint has been installed and the on indicator is lit:

1. Turn the vehicle off.
2. Remove the child restraint from the vehicle.

3. Remove any additional items from the seat such as blankets, cushions, seat covers, seat heaters, or seat massagers.
4. Reinstall the child restraint following the directions provided by the child restraint manufacturer and refer to *Securing Child Restraints (Rear Seat) on page 3-51* or *Securing Child Restraints (Front Passenger Seat) on page 3-53*.
5. If, after reinstalling the child restraint and restarting the vehicle, the on indicator is still lit, turn the vehicle off. Then slightly recline the vehicle seatback and adjust the seat cushion, if adjustable, to make sure that the vehicle seatback is not pushing the child restraint into the seat cushion.

Also make sure the child restraint is not trapped under the vehicle head restraint. If this happens, adjust the head restraint. See *Head Restraints on page 3-2*.

6. Restart the vehicle.

The passenger sensing system may or may not turn off the airbag for a child in a child restraint depending upon the child's size. It is better to secure the child restraint in a rear seat.

If the Off Indicator Is Lit for an Adult-Sized Occupant



If a person of adult size is sitting in the front outboard passenger seat, but the off indicator is lit, it could be because that person is not sitting properly in the seat. Use the following steps to allow the system to detect that person and enable the front outboard passenger frontal airbag:

1. Turn the vehicle off.

2. Remove any additional material from the seat, such as blankets, cushions, seat covers, seat heaters, or seat massagers. Also remove laptops, or other electronic devices.
3. Place the seatback in the fully upright position.
4. Have the person sit upright in the seat, centered on the seat cushion, with legs comfortably extended.
5. Restart the vehicle and have the person remain in this position for two to three minutes after the on indicator is lit.

Warning

If the front outboard passenger airbag is turned off for an adult-sized occupant, the airbag will not be able to inflate and help protect that person in a crash, resulting in an increased risk of

(Continued)

Warning (Continued)

serious injury or even death. An adult-sized occupant should not ride in the front outboard passenger seat, if the passenger airbag off indicator is lit.

Additional Factors Affecting System Operation

Safety belts help keep the passenger in position on the seat during vehicle maneuvers and braking, which helps the passenger sensing system maintain the passenger airbag status. See “Safety Belts” and “Child Restraints” in the Index for additional information about the importance of proper restraint use.

A thick layer of additional material, such as a blanket or cushion, or aftermarket equipment such as seat covers, seat heaters, and seat massagers can affect how well the passenger sensing system

3-34 Seats and Restraints

operates. We recommend that you not use seat covers or other aftermarket equipment except when approved by GM for your specific vehicle. See *Adding Equipment to the Airbag-Equipped Vehicle on page 3-35* for more information about modifications that can affect how the system operates.

A wet seat can affect the performance of the passenger sensing system. Here is how:

- The passenger sensing system may turn off the passenger airbag when liquid is soaked into the seat. If this happens, the off indicator will be lit, and the airbag readiness light on the instrument panel will also be lit.
- Liquid pooled on the seat that has not soaked in may make it more likely that the passenger sensing system will turn on the passenger airbag while a child restraint or child occupant is on

the seat. If the passenger airbag is turned on, the on indicator will be lit.

If the passenger seat gets wet, dry the seat immediately. If the airbag readiness light is lit, do not install a child restraint or allow anyone to occupy the seat. See *Airbag Readiness Light on page 5-16* for important safety information.

The on indicator may be lit if an object, such as a briefcase, handbag, grocery bag, laptop or other electronic device, is put on an unoccupied seat. If this is not desired remove the object from the seat.

Warning

Stowing of articles under the passenger seat or between the passenger seat cushion and seatback may interfere with the proper operation of the passenger sensing system.

Servicing the Airbag-Equipped Vehicle

Airbags affect how the vehicle should be serviced. There are parts of the airbag system in several places around the vehicle. Your dealer and the service manual have information about servicing the vehicle and the airbag system. To purchase a service manual, see *Service Publications Ordering Information on page 13-11*.

Warning

For up to 10 seconds after the vehicle is turned off and the battery is disconnected, an airbag can still inflate during improper service. You can be injured if you are close to an airbag when it inflates. Avoid yellow connectors. They are probably part of the airbag system. Be sure to follow

(Continued)

Warning (Continued)

proper service procedures, and make sure the person performing work for you is qualified to do so.

Adding Equipment to the Airbag-Equipped Vehicle

Adding accessories that change the vehicle's frame, bumper system, height, front end, or side sheet metal may keep the airbag system from working properly.

The operation of the airbag system can also be affected by changing any parts of the front seats, safety belts, airbag sensing and diagnostic module, steering wheel, instrument panel, roof-rail airbag modules, ceiling or pillar garnish trim, overhead console, front sensors, side impact sensors, airbag wiring, or the front center console if the vehicle has a front center airbag.

Your dealer and the service manual have information about the location of the airbag sensors, sensing and diagnostic module, and airbag wiring.

In addition, the vehicle has a passenger sensing system that includes sensors as part of the front outboard passenger seat. The passenger sensing system may not operate properly if the original seat trim is replaced with non-GM covers, upholstery, or trim, or; with GM covers, upholstery, or trim designed for a different vehicle. Any object, such as an aftermarket seat heater or a comfort-enhancing pad or device, installed under or on top of the seat fabric, could also interfere with the operation of the passenger sensing system. This could either prevent proper deployment of the passenger airbag(s) or prevent the passenger sensing system from properly turning off the passenger airbag(s). See *Passenger Sensing System* on page 3-30.

If the vehicle has rollover roof-rail airbags, see *Different Size Tires and Wheels* on page 10-52 for additional information.

If you have to modify your vehicle because you have a disability and you have questions about whether the modifications will affect the vehicle's airbag system, or if you have questions about whether the airbag system will be affected if the vehicle is modified for any other reason, call Customer Assistance. See *Customer Assistance Offices* on page 13-3.

Airbag System Check

The airbag system does not need regularly scheduled maintenance or replacement. Make sure the airbag readiness light is working. See *Airbag Readiness Light* on page 5-16.

Caution

If an airbag covering is damaged, opened, or broken, the airbag may not work properly. Do not open or break the airbag coverings. If there are any opened or broken airbag coverings, have the airbag covering and/or airbag module replaced. For the location of the airbags, see *Where Are the Airbags?* on page 3-25. See your dealer for service.

Replacing Airbag System Parts after a Crash

Warning

A crash can damage the airbag systems in the vehicle.
A damaged airbag system may not work properly and may not

(Continued)

Warning (Continued)

protect you and your passenger(s) in a crash, resulting in serious injury or even death. To help make sure the airbag systems are working properly after a crash, have them inspected and any necessary replacements made as soon as possible.

If an airbag inflates, you will need to replace airbag system parts. See your dealer for service.

If the airbag readiness light stays on after the vehicle is started or comes on when you are driving, the airbag system may not work properly. Have the vehicle serviced right away. See *Airbag Readiness Light* on page 5-16.

Child Restraints

Older Children



Older children who have outgrown booster seats should wear the vehicle safety belts.

The manufacturer instructions that come with the booster seat state the weight and height limitations for that booster. Use a booster seat with a lap-shoulder belt until the child passes the fit test below:

- Sit all the way back on the seat. Do the knees bend at the seat edge? If yes, continue. If no, return to the booster seat.
- Buckle the lap-shoulder belt. Does the shoulder belt rest on the shoulder? If yes, continue. If no, try using the rear safety belt comfort guide, if available. See “Rear Safety Belt Comfort Guides” under *Lap-Shoulder Belt on page 3-16*. If a comfort guide is not available, or if the shoulder belt still does not rest on the shoulder, then return to the booster seat.
- Does the lap belt fit low and snug on the hips, touching the thighs? If yes, continue. If no, return to the booster seat.

- Can proper safety belt fit be maintained for the length of the trip? If yes, continue. If no, return to the booster seat.

Q: What is the proper way to wear safety belts?

A: An older child should wear a lap-shoulder belt and get the additional restraint a shoulder belt can provide. The shoulder belt should not cross the face or neck. The lap belt should fit snugly below the hips, just touching the top of the thighs. This applies belt force to the child’s pelvic bones in a crash. It should never be worn over the abdomen, which could cause severe or even fatal internal injuries in a crash.

Also see “Rear Safety Belt Comfort Guides” under *Lap-Shoulder Belt on page 3-16*.

According to accident statistics, children are safer when properly restrained in a rear seating position.

In a crash, children who are not buckled up can strike other people who are buckled up, or can be thrown out of the vehicle. Older children need to use safety belts properly.

 Warning
Never allow more than one child to wear the same safety belt. The safety belt cannot properly spread the impact forces. In a crash, they can be crushed together and seriously injured. A safety belt must be used by only one person at a time.



Warning

Never allow a child to wear the safety belt with the shoulder belt behind their back. A child can be seriously injured by not wearing the lap-shoulder belt properly. In a crash, the child would not be restrained by the shoulder belt. The child could move too far forward increasing the chance of head and neck injury. The child might also slide under the lap

(Continued)

Warning (Continued)

belt. The belt force would then be applied right on the abdomen. That could cause serious or fatal injuries. The shoulder belt should go over the shoulder and across the chest.



Warning

Children can be seriously injured or strangled if a shoulder belt is wrapped around their neck. The shoulder belt can tighten but cannot be loosened if it is locked. The shoulder belt locks when it is pulled all the way out of the retractor. It unlocks when the shoulder belt is allowed to go all

(Continued)

Infants and Young Children

Everyone in a vehicle needs protection! This includes infants and all other children. Neither the distance traveled nor the age and size of the traveler changes the need, for everyone, to use safety restraints. In fact, the law in every state in the United States and in every Canadian province says children up to some age must be restrained while in a vehicle.

Warning (Continued)

the way back into the retractor, but it cannot do this if it is wrapped around a child's neck. If the shoulder belt is locked and tightened around a child's neck, the only way to loosen the belt is to cut it.

Never leave children unattended in a vehicle and never allow children to play with the safety belts.

Every time infants and young children ride in vehicles, they should have the protection provided by appropriate child restraints. Neither the vehicle's safety belt system nor its airbag system is designed for them.

Children who are not restrained properly can strike other people, or can be thrown out of the vehicle.

Warning

Never hold an infant or a child while riding in a vehicle. Due to crash forces, an infant or a child will become so heavy it is not possible to hold it during a crash. For example, in a crash at only 40 km/h (25 mph), a 5.5 kg (12 lb) infant will suddenly become a 110 kg (240 lb) force on a person's arms. An infant should be secured in an appropriate restraint.



Warning

Children who are up against, or very close to, any airbag when it inflates can be seriously injured or killed. Never put a rear-facing child restraint in the front passenger seat. Secure a rear-facing child restraint in a rear seat.

It is also better to secure a forward-facing child restraint in a rear seat. If a forward-facing child

(Continued)

Warning (Continued)

restraint must be secured in the front passenger seat, always move the front passenger seat as far back as it will go.

If a child restraint is installed in the second row center seat, move the second row seat to the rearward position, whenever possible, to minimize contact with the front center airbag, if equipped.



Q: What are the different types of add-on child restraints?

A: Add-on child restraints, which are purchased by the vehicle owner, are available in four basic types. Selection of a particular restraint should take into consideration not only the child's weight, height, and age but also whether or not the restraint will be compatible with the motor vehicle in which it will be used.

For most basic types of child restraints, there are many different models available. When purchasing a child restraint, be

sure it is designed to be used in a motor vehicle. If it is, the restraint will have a label saying that it meets federal motor vehicle safety standards.

The restraint manufacturer instructions that come with the restraint state the weight and height limitations for a particular child restraint. In addition, there are many kinds of restraints available for children with special needs.

Warning

To reduce the risk of neck and head injury during a crash, infants need complete support. In a crash, if an infant is in a rear-facing child restraint, the crash forces can be distributed across the strongest part of an infant's body, the back and shoulders. Infants should always be secured in rear-facing child restraints.

⚠ Warning

A young child's hip bones are still so small that the vehicle's regular safety belt may not remain low on the hip bones, as it should. Instead, it may settle up around the child's abdomen. In a crash, the belt would apply force on a body area that is unprotected by any bony structure. This alone could cause serious or fatal injuries. To reduce the risk of serious or fatal injuries during a crash, young children should always be secured in appropriate child restraints.

Child Restraint Systems**Rear-Facing Infant Seat**

A rear-facing infant seat provides restraint with the seating surface against the back of the infant.

The harness system holds the infant in place and, in a crash, acts to keep the infant positioned in the restraint.

**Forward-Facing Child Seat**

A forward-facing child seat provides restraint for the child's body with the harness.

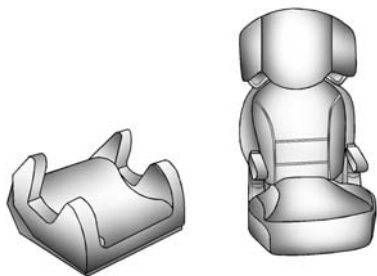

Booster Seats

A booster seat is a child restraint designed to improve the fit of the vehicle's safety belt system. A booster seat can also help a child to see out the window.

Securing an Add-On Child Restraint in the Vehicle

Warning

A child can be seriously injured or killed in a crash if the child restraint is not properly secured in the vehicle. Secure the child restraint properly in the vehicle using the vehicle safety belt or LATCH system, following the instructions that came with that child restraint and the instructions in this manual.

To help reduce the chance of injury, the child restraint must be secured in the vehicle. Child restraint systems must be secured in vehicle seats by lap belts or the lap belt portion of a lap-shoulder belt, or by the LATCH system. See *Lower Anchors and Tethers for Children (LATCH System)* on page 3-44.

Children can be endangered in a crash if the child restraint is not properly secured in the vehicle.

When securing an add-on child restraint, refer to the instructions that come with the restraint which may be on the restraint itself or in a booklet, or both, and to this manual. The child restraint instructions are important, so if they are not available, obtain a replacement copy from the manufacturer.

Keep in mind that an unsecured child restraint can move around in a collision or sudden stop and injure people in the vehicle. Be sure to properly secure any child restraint in the vehicle — even when no child is in it.

In some areas of the United States and Canada, Certified Child Passenger Safety Technicians (CPSTs) are available to inspect and demonstrate how to correctly use and install child restraints. In the U.S., refer to the National Highway Traffic Safety

Administration (NHTSA) website to locate the nearest child safety seat inspection station. For CPST availability in Canada, check with Transport Canada or the Provincial Ministry of Transportation office.

Securing the Child Within the Child Restraint

 **Warning**

A child can be seriously injured or killed in a crash if the child is not properly secured in the child restraint. Secure the child properly following the instructions that came with that child restraint.

Where to Put the Restraint

According to accident statistics, children and infants are safer when properly restrained in a child restraint system or infant restraint system secured in a rear seating position.

Whenever possible, children age 12 and under should be secured in a rear seating position.

The vehicle may be equipped with a front center airbag in the inboard side of the driver seat. Even with a front center airbag, a child restraint can be installed in any second row seating position.

Never put a rear-facing child seat in the front. This is because the risk to the rear-facing child is so great if the airbag deploys.

 **Warning**

A child in a rear-facing child restraint can be seriously injured or killed if the right front passenger airbag inflates. This is because the back of the rear-facing child restraint would be very close to the inflating airbag. A child in a forward-facing child restraint can be seriously

(Continued)

Warning (Continued)

injured or killed if the right front passenger airbag inflates and the passenger seat is in a forward position.

Even if the passenger sensing system has turned off the right front passenger frontal airbag, no system is fail-safe. No one can guarantee that an airbag will not deploy under some unusual circumstance, even though it is turned off. Secure rear-facing child restraints in a rear seat, even if the front passenger frontal airbag is off.

It is also better to secure a forward-facing child restraint in a rear seat. If a forward-facing child restraint must be secured in the right front seat, always move the front passenger seat as far back as it will go.

(Continued)

Warning (Continued)

See *Passenger Sensing System* on page 3-30 for additional information.

If a child restraint is installed in a second row center seat, move the second row seat to the rearward position, whenever possible, to minimize contact with the front center airbag, if equipped.

When securing a child restraint in a rear seating position, study the instructions that came with the child restraint to make sure it is compatible with this vehicle.

Child restraints and booster seats vary considerably in size, and some may fit in certain seating positions better than others. Always make sure the child restraint is properly secured.

Depending on where you place the child restraint and the size of the child restraint, you may not be able

to access adjacent safety belt assemblies or LATCH anchors for additional passengers or child restraints. Adjacent seating positions should not be used if the child restraint prevents access to or interferes with the routing of the safety belt.

Wherever a child restraint is installed, be sure to secure the child restraint properly.

Keep in mind that an unsecured child restraint can move around in a collision or sudden stop and injure people in the vehicle. Be sure to properly secure any child restraint in the vehicle — even when no child is in it.

Lower Anchors and Tethers for Children (LATCH System)

The LATCH system secures a child restraint during driving or in a crash. LATCH attachments on the child restraint are used to attach the child

restraint to the anchors in the vehicle. The LATCH system is designed to make installation of a child restraint easier.

In order to use the LATCH system in your vehicle, you need a child restraint that has LATCH attachments. LATCH-compatible rear-facing and forward-facing child seats can be properly installed using either the LATCH anchors or the vehicle's safety belts. Do not use both the safety belts and the LATCH anchorage system to secure a rear-facing or forward-facing child seat.

Booster seats use the vehicle's safety belts to secure the child in the booster seat. If the manufacturer recommends that the booster seat be secured with the LATCH system, this can be done as long as the booster seat can be positioned properly and there is no interference with the proper positioning of the lap-shoulder belt on the child.

Make sure to follow the instructions that came with the child restraint, and also the instructions in this manual.

When installing a child restraint with a top tether, you must also use either the lower anchors or the safety belts to properly secure the child restraint. A child restraint must never be installed using only the top tether and anchor.

The LATCH anchorage system can be used until the combined weight of the child plus the child restraint is 29.5 kg (65 lbs). Use the safety belt alone instead of the LATCH anchorage system once the combined weight is more than 29.5 kg (65 lbs).

The following explains how to attach a child restraint with these attachments in the vehicle.

Not all vehicle seating positions or child restraints have lower anchors and attachments or top tether anchors and attachments.

Lower Anchors

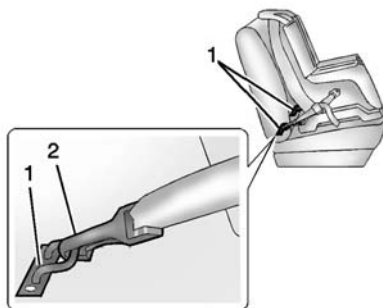

Lower anchors (1) are metal bars built into the vehicle. There are two lower anchors for each LATCH seating position that will accommodate a child restraint with lower attachments (2).

Top Tether Anchor

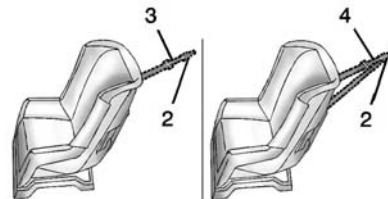

A top tether (3, 4) anchors the top of the child restraint to the vehicle. A top tether anchor is built into the vehicle. The top tether attachment (2) on the child restraint connects to the top tether anchor in the vehicle in order to reduce the forward movement and rotation of the child restraint during driving or in a crash.

3-46 Seats and Restraints

The child restraint may have a single tether (3) or a dual tether (4). Either will have a single attachment (2) to secure the top tether to the anchor.

Some child restraints with top tethers are designed for use with or without the top tether being attached. Others require the top tether always to be attached. In Canada, the law requires that forward-facing child restraints have a top tether, and that the tether be attached. Be sure to read and follow the instructions for your child restraint.

Lower Anchor and Top Tether Anchor Locations

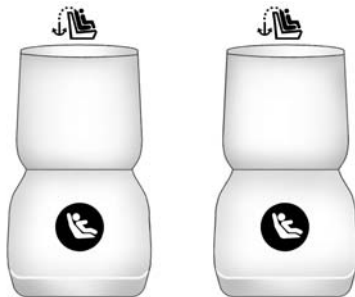

Second Row — Bucket

 (Top Tether Anchor): Seating positions with top tether anchors.

 (Lower Anchor): Seating positions with two lower anchors.

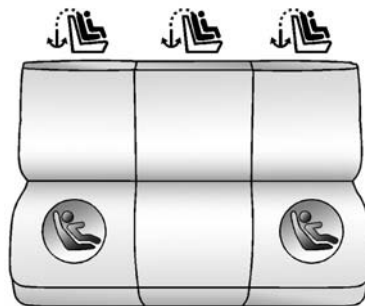

Second Row — 60/40 Bench

 (Top Tether Anchor): Seating positions with top tether anchors.

 (Lower Anchor): Seating positions with two lower anchors.

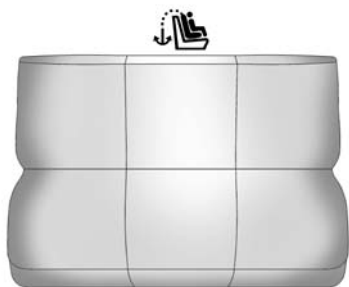

Third Row

 **(Top Tether Anchor):** Seating positions with top tether anchors.



To assist in locating the lower anchors, each second row anchor position has a label, near the crease between the seatback and the seat cushion.



To assist in locating the top tether anchors, the top tether anchor symbol is near the anchor.

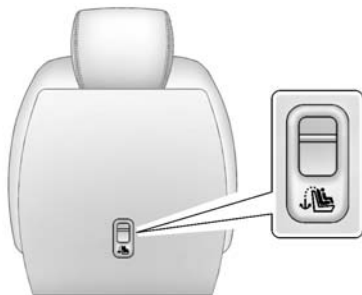

Second Row — Bucket Shown, Bench Similar

The top tether anchors are at the bottom rear of the seatback for each seating position in the second row.

Be sure to use an anchor on the same side of the vehicle as the seating position where the child restraint will be placed.

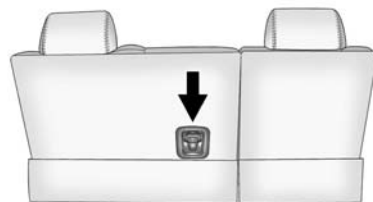

Third Row

The third row has one top tether anchor at the bottom rear of the center seatback. This anchor should be used for the center seating position only. Never install two top tethers using the same top tether anchor.

Do not secure a child restraint in a position without a top tether anchor if a national or local law requires

3-48 Seats and Restraints

that the top tether be attached, or if the instructions that come with the child restraint say that the top tether must be attached.

According to accident statistics, children and infants are safer when properly restrained in a child restraint system or infant restraint system secured in a rear seating position. See *Where to Put the Restraint* on page 3-43 for additional information.

Securing a Child Restraint Designed for the LATCH System

Warning

If a LATCH-type child restraint is not attached to anchors or with the safety belt, the child restraint will not be able to protect the child correctly. In a crash, the child could be seriously injured or killed. Install a LATCH-type child

(Continued)

Warning (Continued)

restraint properly using the anchors, or use the vehicle safety belts to secure the restraint, following the instructions that came with the child restraint and the instructions in this manual.

Warning

Do not attach more than one child restraint to a single anchor. Attaching more than one child restraint to a single anchor could cause the anchor or attachment to come loose or even break during a crash. A child or others could be injured. To reduce the risk of serious or fatal injuries during a crash, attach only one child restraint per anchor.

Warning

Children can be seriously injured or strangled if a shoulder belt is wrapped around their neck. The shoulder belt can tighten but cannot be loosened if it is locked. The shoulder belt locks when it is pulled all the way out of the retractor. It unlocks when the shoulder belt is allowed to go all the way back into the retractor, but it cannot do this if it is wrapped around a child's neck. If the shoulder belt is locked and tightened around a child's neck, the only way to loosen the belt is to cut it.

Buckle any unused safety belts behind the child restraint so children cannot reach them. Pull the shoulder belt all the way out of the retractor to set the lock, and tighten the belt behind the child restraint after the child restraint has been installed.

 **Caution**

Do not let the LATCH attachments rub against the vehicle's safety belts. This may damage these parts. If necessary, move buckled safety belts to avoid rubbing the LATCH attachments.

Do not fold the empty rear seat with a safety belt buckled. This could damage the safety belt or the seat. Unbuckle and return the safety belt to its stowed position, before folding the seat.

The vehicle may be equipped with a front center airbag in the inboard side of the driver seat. Even with a front center airbag, a child restraint can be installed in any second row seating position. If a child restraint is installed in a second row center seat, move the second row seat to

the rearward position, whenever possible, to minimize contact with the front center airbag.

If you need to secure more than one child restraint in the rear seat, see *Where to Put the Restraint on page 3-43*.

This system is designed to make installation of child restraints easier. When using lower anchors, do not use the vehicle's safety belts. Instead, use the vehicle's anchors and child restraint attachments to secure the restraints. Some restraints also use another vehicle anchor to secure a top tether.

1. Attach and tighten the lower attachments to the lower anchors. If the child restraint does not have lower attachments or the desired seating position does not have lower anchors, secure the child restraint with the top tether and the safety belts. Refer to your

child restraint manufacturer instructions and the instructions in this manual.

- 1.1. Find the lower anchors for the desired seating position.
- 1.2. To access the lower anchors in the second row, it may help to recline the seatback.
Third row seatbacks must be upright before placing the child restraint on the seat.
- 1.3. Put the child restraint on the seat.
- 1.4. Attach and tighten the lower attachments on the child restraint to the lower anchors.

If necessary, adjust the angle of the second row seatback to achieve a tight installation. Make sure the

3-50 Seats and Restraints

second row bench seatbacks are aligned at the same angle.

2. If the child restraint manufacturer recommends that the top tether be attached, attach and tighten the top tether to the top tether anchor, if the vehicle has one. Refer to the child restraint instructions and the following steps:
 - 2.1. Find the top tether anchor.
 - 2.2. Route, attach, and tighten the top tether according to your child restraint instructions and the following instructions:

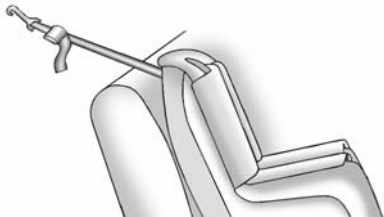

If the position you are using does not have a headrest or head restraint and you are using a single tether, route the tether over the seatback.

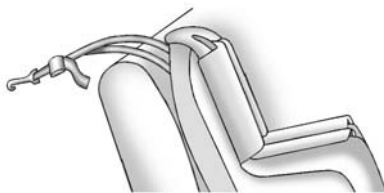

If the position you are using does not have a headrest or head restraint and you are using a dual tether, route the tether over the seatback.

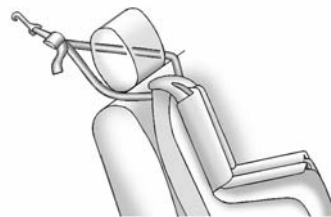

If the position you are using has a fixed headrest or head restraint and you are using a dual tether, route the tether around the headrest or head restraint.



If the position you are using has a fixed headrest or head restraint and you are

using a single tether, route the tether over the headrest or head restraint.

- Before placing a child in the child restraint, make sure it is securely held in place. To check, grasp the child restraint at the LATCH path and attempt to move it side to side and back and forth. There should be no more than 2.5 cm (1 in) of movement, for proper installation.

Replacing LATCH System Parts After a Crash

Warning

A crash can damage the LATCH system in the vehicle. A damaged LATCH system may not properly secure the child restraint, resulting in serious injury or even death in a crash. To help make sure the LATCH system is

(Continued)

Warning (Continued)

working properly after a crash, see your dealer to have the system inspected and any necessary replacements made as soon as possible.

If the vehicle has the LATCH system and it was being used during a crash, new LATCH system parts may be needed.

New parts and repairs may be necessary even if the LATCH system was not being used at the time of the crash.

Securing Child Restraints (Rear Seat)

The vehicle may be equipped with a front center airbag in the inboard side of the driver seat. Even with a front center airbag, a child restraint can be installed in any second row seating position. If you install a child restraint in a second row center

seat, move the second row seat to the rearward position, whenever possible, to minimize contact with the front center airbag.

When securing a child restraint in a rear seating position, study the instructions that came with the child restraint to make sure it is compatible with this vehicle.

If the child restraint has the LATCH system, see *Lower Anchors and Tethers for Children (LATCH System)* on page 3-44 for how and where to install the child restraint using LATCH. If a child restraint is secured in the vehicle using a safety belt and it uses a top tether, see *Lower Anchors and Tethers for Children (LATCH System)* on page 3-44 for top tether anchor locations.

Do not secure a child seat in a position without a top tether anchor if a national or local law requires that the top tether be anchored, or if

3-52 Seats and Restraints

the instructions that come with the child restraint say that the top strap must be anchored.

In Canada, the law requires that forward-facing child restraints have a top tether, and that the tether be attached.

If the child restraint or vehicle seat position does not have the LATCH system, you will be using the safety belt to secure the child restraint in this position. Be sure to follow the instructions that came with the child restraint. Secure the child in the child restraint when and as the instructions say.

If more than one child restraint needs to be installed in the rear seat, be sure to read *Where to Put the Restraint on page 3-43*.

1. Put the child restraint on the seat.
2. Pick up the latch plate, and run the lap and shoulder portions of the vehicle's safety belt through

or around the restraint. The child restraint instructions will show you how.



3. Push the latch plate into the buckle until it clicks.

Position the release button on the buckle so that the safety belt could be quickly unbuckled if necessary.



4. Pull the shoulder belt all the way out of the retractor to set the lock. When the retractor lock is set, the shoulder belt can be tightened but not pulled out of the retractor.

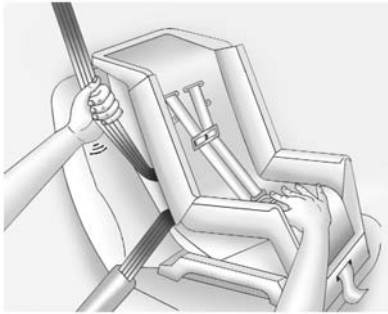

5. To tighten the belt, push down on the child restraint, pull the shoulder portion of the belt to tighten the lap portion of the belt, and feed the shoulder belt back into the retractor. When installing a forward-facing child restraint, it may be helpful to use your knee to push down on the child restraint as you tighten the belt. Try to pull the belt out of the retractor to make sure the retractor is locked. If the retractor is not locked, repeat Steps 4 and 5.
6. If the child restraint has a top tether, follow the child restraint manufacturer's instructions regarding the use of the top tether. See *Lower Anchors and Tethers for Children (LATCH System)* on page 3-44 for more information.
7. Before placing a child in the child restraint, make sure it is securely held in place. To check, grasp the child restraint at the safety belt path and attempt to move it side to side and back and forth. When the child restraint is properly installed, there should be no more than 2.5 cm (1 in) of movement.

To remove the child restraint, unbuckle the vehicle safety belt and let it return to the stowed position. If the top tether is attached to a top tether anchor, disconnect it.

Securing Child Restraints (Front Passenger Seat)

The vehicle has airbags. A rear seat is a safer place to secure a forward-facing child restraint. See *Where to Put the Restraint* on page 3-43.

In addition, the vehicle has a passenger sensing system which is designed to turn off the front outboard passenger frontal airbag under certain conditions. See *Passenger Sensing System* on page 3-30 and *Passenger Airbag Status Indicator* on page 5-17 for more information, including important safety information.

Never put a rear-facing child seat in the front. This is because the risk to the rear-facing child is so great, if the airbag deploys.

Warning

A child in a rear-facing child restraint can be seriously injured or killed if the front outboard passenger frontal airbag inflates. This is because the back of the rear-facing child restraint would be very close to the inflating airbag. A child in a forward-facing child restraint can be seriously injured or killed if the front outboard passenger frontal airbag inflates and the passenger seat is in a forward position.

Even if the passenger sensing system has turned off the front outboard passenger frontal airbag, no system is fail-safe. No one can guarantee that an airbag will not deploy under some unusual circumstance, even though it is turned off.

(Continued)

Warning (Continued)

Secure rear-facing child restraints in a rear seat, even if the airbag is off. If you secure a forward-facing child restraint in the front seat, always move the front passenger seat as far back as it will go. It is better to secure the child restraint in a rear seat.

See *Passenger Sensing System on page 3-30* for additional information.

If the child restraint uses a top tether, see *Lower Anchors and Tethers for Children (LATCH System) on page 3-44* for top tether anchor locations.

Do not secure a child seat in a position without a top tether anchor if a national or local law requires that the top tether be anchored, or if the instructions that come with the child restraint say that the top strap must be anchored.

In Canada, the law requires that forward-facing child restraints have a top tether, and that the tether be attached.

When using the lap-shoulder belt to secure the child restraint in this position, follow the instructions that came with the child restraint and the following instructions:

1. Move the seat as far back as it will go before securing the forward-facing child restraint.

When the passenger sensing system has turned off the front outboard passenger frontal airbag, the off indicator on the passenger airbag status indicator should light and stay lit when the vehicle is started. See *Passenger Airbag Status Indicator on page 5-17*.

2. Put the child restraint on the seat.
3. Pick up the latch plate, and run the lap and shoulder portions of the vehicle's safety belt through

or around the restraint. The child restraint instructions will show you how.



4. Push the latch plate into the buckle until it clicks.

Position the release button on the buckle so that the safety belt could be quickly unbuckled if necessary.



5. Pull the shoulder belt all the way out of the retractor to set the lock. When the retractor lock is set, the belt can be tightened but not pulled out of the retractor.

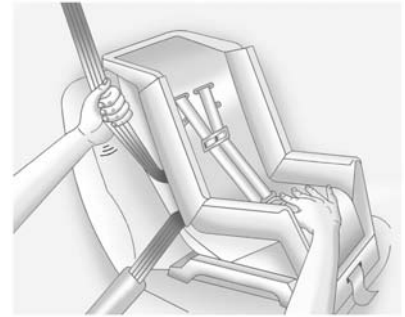

6. To tighten the belt, push down on the child restraint, pull the shoulder portion of the belt to tighten the lap portion of the belt, and feed the shoulder belt back into the retractor. When installing a forward-facing child restraint, it may be helpful to use your knee to push down on the child restraint as you tighten the belt.

Try to pull the belt out of the retractor to make sure the retractor is locked. If the retractor is not locked repeat Steps 5 and 6.

3-56 Seats and Restraints

7. Before placing a child in the child restraint, make sure it is securely held in place. To check, grasp the child restraint at the safety belt path and attempt to move it side to side and back and forth. When the child restraint is properly installed, there should be no more than 2.5 cm (1 in) of movement.

If the airbag is off, the off indicator in the passenger airbag status indicator will come on and stay on when the vehicle is started.

If a child restraint has been installed and the on indicator is lit, see “If the On Indicator Is Lit for a Child Restraint” under *Passenger Sensing System* on page 3-30 for more information.

To remove the child restraint, unbuckle the vehicle safety belt and let it return to the stowed position.

Storage

Storage Compartments

Storage Compartments	4-1
Instrument Panel Storage	4-1
Glove Box	4-2
Cupholders	4-2
Armrest Storage	4-2
Center Console Storage	4-2

Additional Storage Features

Cargo Cover	4-3
Cargo Tie-Downs	4-3
Cargo Management System	4-3
Convenience Net	4-4

Roof Rack System

Roof Rack System	4-5
------------------------	-----

Storage Compartments

⚠ Warning

Do not store heavy or sharp objects in storage compartments. In a crash, these objects may cause the cover to open and could result in injury.

Instrument Panel Storage



This vehicle has an instrument panel storage area. To open the cover, pull the latch forward.

4-2 Storage

Glove Box

Lift the glove box handle to open it. Use the key to lock and unlock the glove box.

Cupholders

There are two cupholders, with removable liners, in front of the center console. There may be cupholders in the second row seat armrest. To access, pull the armrest down. There are additional cupholders on each side of the third row seat and in each door.

Armrest Storage



If equipped, the rear seat armrest may have two cupholders. Pull the armrest down to access the cupholders.

Center Console Storage

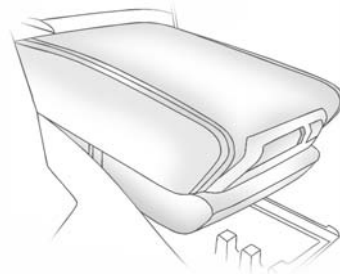

Pull up the lever on the front of the center console armrest to slide it forward and backward. To open the armrest storage area, press the button on the front of the armrest.

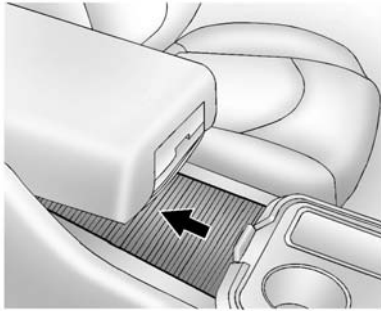

There is additional storage under the armrest. Move the armrest all the way to the rear position, then slide the storage cover back to access.

There is a removable tray in the storage area. Pull up on the tray to remove and access the lower storage area and power outlet. See *Power Outlets on page 5-9*.

There may be two charging USB ports on the rear of the console. See *Auxiliary Devices on page 7-31*.

Additional Storage Features

Cargo Cover

For vehicles with a cargo cover, it can be used to cover items in the rear of the vehicle. To install the cover, place the loops on each corner of the cover on the four hooks in the rear of the vehicle. The cover should be stored securely when not in use.

Cargo Tie-Downs

Four cargo tie-downs are located in the rear compartment of the vehicle. The tie-downs can be used to secure small loads.

Cargo Management System

This vehicle has a cargo management system located in the rear.

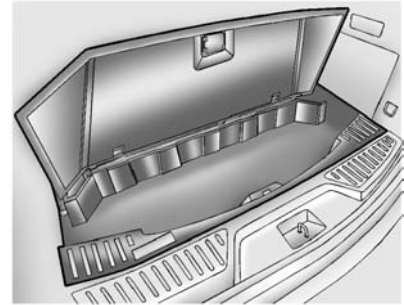

To remove the cargo management cover:

1. Open the cover. It remains open when lifted.
2. Pull the cover up making sure to unhook the hinges at the rear of the cover.
3. Store the cover outside the vehicle or reattach before driving.

4-4 Storage

Warning

An improperly latched and closed cargo cover, or cargo cover left in the open position, could be thrown about the vehicle during a crash or sudden maneuver. Someone could be injured. Be sure to return the cover to the closed position and latch before driving. If the cover is removed, always store it outside of the vehicle. When it is replaced, always be sure that it is securely reattached.

Convenience Net

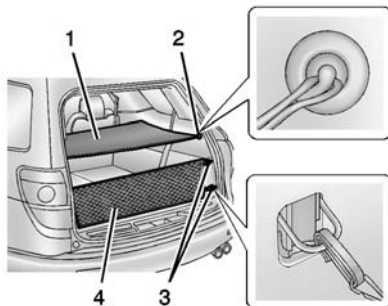

Power Liftgate Shown, Manual Liftgate Similar

1. Cargo Cover
2. Cargo Cover Hooks
3. Cargo Tie-Downs
4. Convenience Net

For vehicles with a convenience net (4), attach it to the vehicle using only the cargo tie-downs (3) on each side. The net is used to store small loads and should not be used for heavy loads.

The cargo cover hooks (2) are used to attach the cargo cover (1) to the vehicle only. Do not use the hooks to secure loads or other items to the vehicle as the hooks could be damaged.

Roof Rack System

Warning

If something is carried on top of the vehicle that is longer or wider than the roof rack — like paneling, plywood, or a mattress — the wind can catch it while the vehicle is being driven. The item being carried could be violently torn off, and this could cause a collision and damage the vehicle. Never carry something longer or wider than the roof rack on top of the vehicle unless using a GM certified accessory carrier.

For vehicles with a roof rack, the rack can be used to load items. For roof racks that do not have crossrails included, GM Certified crossrails can be purchased as an accessory. See your dealer for additional information.

Caution

Loading cargo on the roof rack that weighs more than 91 kg (200 lb) or hangs over the rear or sides of the vehicle may damage the vehicle. Load cargo so that it rests evenly between the crossrails and fasten cargo securely.

To prevent damage or loss of cargo when driving, check to make sure crossrails and cargo are securely fastened. Loading cargo on the roof rack will make the vehicle's center of gravity higher. Avoid high speeds, sudden starts, sharp turns, sudden braking, or abrupt maneuvers; otherwise it may result in loss of control. If driving for a long distance, on rough roads, or at high speeds, occasionally stop the vehicle to make sure the cargo remains in its place. Do not exceed the maximum vehicle capacity when loading the vehicle.

See *Vehicle Load Limits* on page 9-9.

Instruments and Controls

Controls

- Steering Wheel Adjustment ... 5-2
- Steering Wheel Controls (Radio without Touchscreen) 5-2
- Steering Wheel Controls (Radio with Touchscreen) 5-3
- Heated Steering Wheel 5-4
- Horn 5-5
- Windshield Wiper/Washer 5-5
- Rear Window Wiper/Washer 5-5
- Compass 5-6
- Clock (Radio without Touchscreen) 5-7
- Clock (Radio with Touchscreen) 5-8
- Power Outlets 5-9

Warning Lights, Gauges, and Indicators

- Warning Lights, Gauges, and Indicators 5-11
- Instrument Cluster 5-12
- Speedometer 5-13

- Odometer 5-13
- Tachometer 5-13
- Fuel Gauge 5-13
- Engine Coolant Temperature Gauge 5-14
- Voltmeter Gauge 5-15
- Safety Belt Reminders 5-15
- Airbag Readiness Light 5-16
- Passenger Airbag Status Indicator 5-17
- Charging System Light 5-17
- Malfunction Indicator Lamp 5-18
- Brake System Warning Light 5-20
- Antilock Brake System (ABS) Warning Light 5-21
- Tow/Haul Mode Light 5-22
- Lane Departure Warning (LDW) Light 5-22
- Vehicle Ahead Indicator 5-22
- StabiliTrak[®] Indicator Light ... 5-23
- Engine Coolant Temperature Warning Light 5-23
- Tire Pressure Light 5-23
- Engine Oil Pressure Light ... 5-24
- Security Light 5-24
- High-Beam On Light 5-25
- Cruise Control Light 5-25

Information Displays

- Driver Information Center (DIC) (With DIC Buttons) ... 5-25
- Driver Information Center (DIC) (Without DIC Buttons) 5-31

Vehicle Messages

- Vehicle Messages 5-34
- Battery Voltage and Charging Messages 5-34
- Brake System Messages 5-35
- Cruise Control Messages 5-35
- Door Ajar Messages 5-35
- Engine Cooling System Messages 5-36
- Engine Oil Messages 5-37
- Engine Power Messages 5-37
- Fuel System Messages 5-38
- Key and Lock Messages 5-38
- Lamp Messages 5-38
- Object Detection System Messages 5-39
- Ride Control System Messages 5-41
- Airbag System Messages 5-41
- Security Messages 5-41
- Service Vehicle Messages ... 5-42
- Tire Messages 5-42

5-2 Instruments and Controls

Transmission Messages	5-43
Vehicle Reminder Messages	5-44
Vehicle Speed Messages	5-44
Washer Fluid Messages	5-44

Vehicle Personalization

Vehicle Personalization (With DIC Buttons)	5-45
---	------

Universal Remote System

Universal Remote System	5-52
Universal Remote System Programming	5-52
Universal Remote System Operation	5-55

Controls

Steering Wheel Adjustment



To adjust the steering wheel:

1. Pull the lever down.
2. Move the steering wheel up or down.
3. Pull or push the steering wheel closer or away from you.
4. Push the lever up to lock the steering wheel in place.

Do not adjust the steering wheel while driving.

Steering Wheel Controls (Radio without Touchscreen)

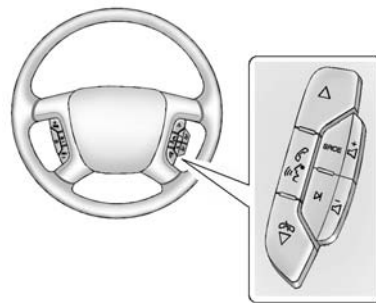



Vehicles with audio steering wheel controls could differ depending on the vehicle's options. Some audio controls can be adjusted at the steering wheel.

△ or  ▽ (Next/Previous):

Press to select preset or favorite radio stations, select tracks on a CD, or select tracks and navigate folders on an iPod® or USB device.

To select tracks on an iPod or USB device:

- Press and hold △ or  ▽ while listening to a song listed in the main audio page to quickly move forward or in reverse through the tracks.
- Track information is displayed on the screen. Release △ or  ▽ when the desired track is reached.

 **(Mute/Press to Talk):** Press to mute the speakers, press again to unmute. Press and hold to interact with Bluetooth and OnStar®, if equipped. See *Bluetooth on page 7-34* and “OnStar,” if equipped.

 ▽ **(End):** Press to reject an incoming call or end a current call.

SRCE (Source): Press to switch between AM, FM, CD, and if equipped, SiriusXM®, front auxiliary, rear auxiliary, and iPod/USB.

▷ **(Seek):** Press to go to the next radio station while in AM, FM, or SiriusXM®.

Press ▷ to go to the next track or chapter while sourced to the CD slot.

Press ▷ to select a track or a folder when navigating folders on an iPod or USB device.

+  or -  **(Volume):** Press to increase or to decrease the volume.

Steering Wheel Controls (Radio with Touchscreen)

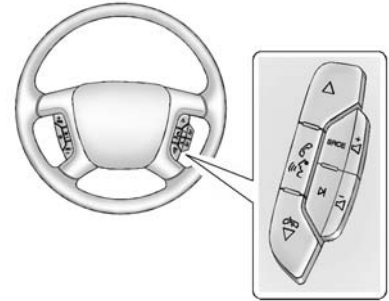





Vehicles with audio steering wheel controls could differ depending on the vehicle's options. Some audio controls can be adjusted at the steering wheel.



△ or  ▽ (Next/Previous): Press to select preset or favorite radio stations, select tracks on a CD, or select tracks and navigate folders on an iPod® or USB device.

5-4 Instruments and Controls

To select tracks on an iPod or USB device:

- Press and hold  or  while listening to a song listed in the main audio page to quickly move forward or in reverse through the tracks.
- Track information is displayed on the screen. Release  or  when the desired track is reached.

  **(Press to Talk):** Press to interact with Bluetooth and OnStar®, if equipped. See *Bluetooth on page 7-34* and “OnStar,” if equipped.

  **(End):** Press to reject an incoming call or end a current call.

SRCE (Source): Press to switch between AM, FM, CD, and if equipped, SiriusXM®, front auxiliary, rear auxiliary, and iPod/USB.

Press and hold to mute/pause the system.

 **(Seek):** Press to go to the next radio station while in AM, FM, or SiriusXM®.

Press  to go to the next track or chapter while sourced to the CD slot.

Press  to select a track or a folder when navigating folders on an iPod or USB device.

+  or -  (Volume): Press to increase or to decrease the volume.

Heated Steering Wheel

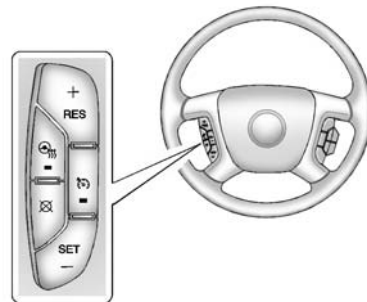

 **(Heated Steering Wheel):** If equipped with a heated steering wheel, press to turn it on or off. A light on the button displays when the feature is turned on.

The steering wheel takes about three minutes to start heating.

Horn

Press  on the steering wheel pad to sound the horn.

Windshield Wiper/Washer

The windshield wiper/washer lever is located on the left side of the steering column.

Turn the band with the wiper symbol to control the windshield wipers.



 **(Mist):** Use for a single wiping cycle.

OFF: Use to turn the wipers off.

 **(Adjustable Interval Wipes):** Delays wiping cycle. Turn the band up for more frequent wipes or down for less frequent wipes.

LO: Slow wipes.

HI: Fast wipes.

Clear ice and snow from the wiper blades before using them. If frozen to the windshield, carefully loosen or thaw them. Damaged wiper blades should be replaced. See *Wiper Blade Replacement* on page 10-25.

Heavy snow or ice can overload the wipers. A circuit breaker stops them until the motor cools.

Windshield Washer

 **FRONT (Washer Fluid):** Press the button at the end of the lever, to spray washer fluid on the windshield. The wipers clear the windshield and either stop or return to the preset speed. The ignition key must be in ACC/ACCESSORY or ON/RUN for this to work. See *Washer Fluid* on page 10-19.

Warning

In freezing weather, do not use the washer until the windshield is warmed. Otherwise the washer fluid can form ice on the windshield, blocking your vision.

WASHER FLUID LOW ADD FLUID is displayed on the Driver Information Center (DIC) when the washer fluid is low. See *Washer Fluid Messages* on page 5-44.

Rear Window Wiper/Washer

The rear wiper and rear wash button is on the center stack below the climate control system.

 **(Rear Wiper):** Press to turn the rear wiper on and off. The wiper speed cannot be changed.

 **(Wash):** Press to spray washer fluid on the rear window. The window wiper will also come on.

5-6 Instruments and Controls

Release the button when enough fluid has been sprayed on the window. The rear wiper will run a few more cycles after it is released. If the rear wiper function was already on prior to pressing the wash button, it stays on until the wiper button is pressed again.

The rear window washer uses the same fluid that is in the windshield washer reservoir. See *Washer Fluid* on page 10-19.

Compass

Your vehicle may have a compass in the Driver Information Center (DIC). See *Driver Information Center (DIC) (With DIC Buttons)* on page 5-25 or *Driver Information Center (DIC) (Without DIC Buttons)* on page 5-31 for more information about the DIC.

Compass Zone

The zone is set to zone eight upon leaving the factory. Your dealer will set the correct zone for your location.

Under certain circumstances, such as during a long distance cross-country trip or moving to a new state or province, it will be necessary to compensate for compass variance by resetting the zone through the DIC if the zone is not set correctly.

Compass variance is the difference between the earth's magnetic north and true geographic north. If the compass is not set to the zone where you live, the compass may give false readings. The compass must be set to the variance zone in which the vehicle is traveling.

To adjust for compass variance, use the following procedure:

Compass Variance (Zone) Procedure

1. Do not set the compass zone when the vehicle is moving. Only set it when the vehicle is in P (Park).

Press the vehicle information button until PRESS ✓ TO CHANGE COMPASS ZONE displays.

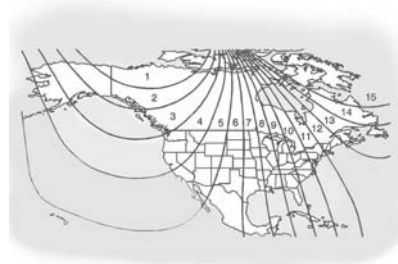

2. Find the vehicle's current location and variance zone number on the map. Zones 1 through 15 are available.
3. Press the set/reset button to scroll through and select the appropriate variance zone.

4. Press the trip/fuel button until the vehicle heading, for example, N for North, is displayed in the DIC.
5. If calibration is necessary, calibrate the compass. See “Compass Calibration Procedure” following.

Compass Calibration

The compass can be manually calibrated. Only calibrate the compass in a magnetically clean and safe location, such as an open parking lot, where driving the vehicle in circles is not a danger. It is suggested to calibrate away from tall buildings, utility wires, manhole covers, or other industrial structures, if possible.

If CAL should ever appear in the DIC display, the compass should be calibrated.

If the DIC display does not show a heading, for example, N for North, or the heading does not change after making turns, there may be a

strong magnetic field interfering with the compass. Such interference may be caused by a magnetic CB or cell phone antenna mount, a magnetic emergency light, magnetic note pad holder, or any other magnetic item. Turn off the vehicle, move the magnetic item, then turn on the vehicle and calibrate the compass.

To calibrate the compass, use the following procedure:

Compass Calibration Procedure

1. Before calibrating the compass, make sure the compass zone is set to the variance zone in which the vehicle is located. See “Compass Variance (Zone) Procedure” earlier in this section.

Do not operate any switches such as window, sunroof, climate controls, seats, etc. during the calibration procedure.







2. Press the vehicle information button until PRESS ✓ TO CALIBRATE COMPASS displays.
3. Press the set/reset button to start the compass calibration.
4. The DIC will display CALIBRATING: DRIVE IN CIRCLES. Drive the vehicle in tight circles at less than 8 km/h (5 mph) to complete the calibration. The DIC will display CALIBRATION COMPLETE for a few seconds when the calibration is complete. The DIC display will then return to the previous menu.

Clock (Radio without Touchscreen)



To adjust the time and date:

1. Turn the ignition key to ACC/ ACCESSORY or ON/RUN, then press ⏻ to turn the radio on.

5-8 Instruments and Controls

2. Press  to display HR, MIN, MM, DD, YYYY (hour, minute, month, day, and year).
3. Press the pushbutton located under any one of the labels to be changed.
4. To increase the time or date, do one of the following:
 - Press the pushbutton below the selected label.
 - Press  SEEK.
 - Press  FWD.
 - Turn  clockwise.
5. To decrease the time or date, do one of the following:
 - Press  SEEK.
 - Press  REV.
 - Turn  counterclockwise.

To change the time default setting from 12 hour to 24 hour or to change the date default setting from month/day/year to day/month/year:

1. Press  and then the pushbutton located under the forward arrow that displays on the radio screen until the time 12H (hour) and 24H (hour), and the date MM/DD (month and day) and DD/MM (day and month) display.
2. Press the pushbutton located under the desired option.
3. Press  again to apply the selected default, or let the screen time out.

Clock (Radio with Touchscreen)

Press Settings on the Home Page Menu, then press the Set Time or Set Date settings screen button to display the different options for setting the time and date.

Set Time:

- Press the up or down arrows to increase or decrease the Hours, Minutes, AM, PM, or the 24 hour setting on the clock.
- Press and hold to quickly increase or decrease the time settings.
- Press OK to save the adjustments.
- Press Back or Cancel screen button to cancel the adjustments.

Set Date:

- Press the up or down arrows to increase or decrease the Month, Day, and Year settings.
- Press and hold to quickly increase or decrease the date settings.
- Press OK to save the adjustments.
- Press Back or Cancel screen button to cancel the adjustments.

Power Outlets

The vehicle has 12-volt outlets that can be used to plug in electrical equipment, such as a cell phone or MP3 player.

The power outlets are located:

- On the center stack below the climate controls.
- Inside the center console.
- At the rear of the center console.
- In the rear cargo area.

Lift the cover to access the outlet and replace when not in use.

Warning

Power is always supplied to the outlets. Do not leave electrical equipment plugged in when the vehicle is not in use because the vehicle could catch fire and cause injury or death.

Caution

Leaving electrical equipment plugged in for an extended period of time while the vehicle is off will drain the battery. Always unplug electrical equipment when not in use and do not plug in equipment that exceeds the maximum 20 amp rating.

Certain accessory plugs may not be compatible with the accessory power outlet and could overload vehicle and adapter fuses. If a problem is experienced, see your dealer.

When adding electrical equipment, be sure to follow the proper installation instructions included with the equipment. See *Add-On Electrical Equipment* on page 9-54.

Caution

Hanging heavy equipment from the power outlet can cause damage not covered by the vehicle warranty. The power outlets are designed for accessory power plugs only, such as cell phone charge cords.

5-10 Instruments and Controls

Power Outlet 120 Volt Alternating Current

If equipped with this power outlet it can be used to plug in electrical equipment that uses a maximum limit of 150 watts.



The power outlet is on the rear of the center console.

An indicator light on the outlet turns on to show it is in use. The light comes on when the ignition is in ON/RUN, equipment requiring less than 150 watts is plugged into the outlet, and no system fault is detected.

The indicator light does not come on when the ignition is in LOCK/OFF or if the equipment is not fully seated into the outlet.

If equipment is connected using more than 150 watts or a system fault is detected, a protection circuit shuts off the power supply and the indicator light turns off. To reset the circuit, unplug the item and plug it back in or turn the Retained Accessory Power (RAP) off and then back on. See *Retained Accessory Power (RAP)* on page 9-18. The power restarts when equipment using 150 watts or less is plugged into the outlet and a system fault is not detected.

The power outlet is not designed for and may not work properly, if the following are plugged in:

- Equipment with high initial peak wattage such as:
compressor-driven refrigerators and electric power tools.

- Other equipment requiring an extremely stable power supply such as:
microcomputer-controlled electric blankets, touch sensor lamps, etc.

See *High Voltage Devices and Wiring* on page 10-28.

Warning Lights, Gauges, and Indicators

Warning lights and gauges can signal that something is wrong before it becomes serious enough to cause an expensive repair or replacement. Paying attention to the warning lights and gauges could prevent injury.

Warning lights come on when there could be a problem with a vehicle function. Some warning lights come on briefly when the engine is started to indicate they are working.

Gauges can indicate when there could be a problem with a vehicle function. Often gauges and warning lights work together to indicate a problem with the vehicle.

When one of the warning lights comes on and stays on while driving, or when one of the gauges shows there may be a problem, check the section that explains what to do. Waiting to do repairs can be costly and even dangerous.

5-12 Instruments and Controls

Instrument Cluster

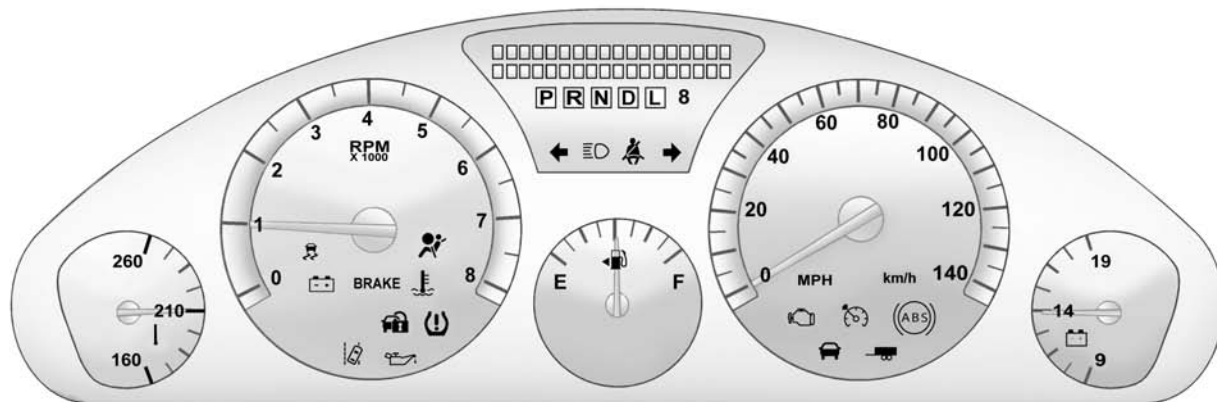

English Uplevel Shown, Metric Similar

Speedometer

The speedometer shows the vehicle's speed in either kilometers per hour (km/h) or miles per hour (mph).

Odometer

The odometer shows how far the vehicle has been driven, in either kilometers or miles.

Tachometer

The tachometer displays the engine speed in revolutions per minute (rpm).

Caution

If the engine is operated with the rpm's in the warning area at the high end of the tachometer, the vehicle could be damaged, and the damage would not be covered by the vehicle warranty. Do not operate the engine with the rpm's in the warning area.

Fuel Gauge



Metric



English

When the ignition is on, the fuel gauge shows how much fuel is left in the tank.

An arrow on the fuel gauge indicates the side of the vehicle the fuel door is on.

The gauge will first indicate empty before the vehicle is out of fuel, but the vehicle's fuel tank should be filled soon.

When the fuel tank is low on fuel, the FUEL LEVEL LOW message will appear on the Driver Information Center (DIC). For more information see *Fuel System Messages* on page 5-38.

Here are some situations that may occur with the fuel gauge. None of these indicate a problem with the fuel gauge.

- At the gas station, the gas pump shuts off before the gauge reads full.

5-14 Instruments and Controls

- It takes a little more or less fuel to fill up than the gauge indicated. For example, the gauge might have indicated the tank was half full, but it actually took a little more or less than half the tank's capacity to fill the tank.
- The gauge moves a little while turning a corner or speeding up.
- The gauge does not go back to empty when the ignition is turned off.

Engine Coolant Temperature Gauge



Metric

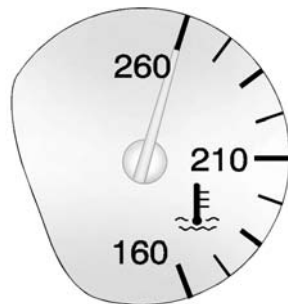

English

This gauge shows the engine coolant temperature. If the gauge pointer moves into the red area, it means that the engine coolant has overheated. If the vehicle has been operated under normal driving conditions, pull off the road, stop the vehicle, and turn off the engine as soon as possible.

See *Engine Overheating* on page 10-16 for more information.

Voltmeter Gauge

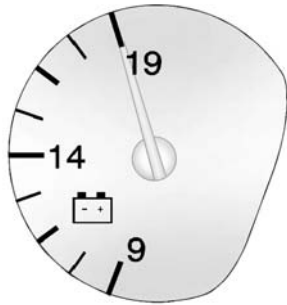

When the engine is not running, but the ignition is on, this gauge displays the battery voltage in DC volts.

When the engine is running, this gauge shows the condition of the charging system. The vehicle's charging system regulates voltage based on the state of charge of the battery. The voltmeter may fluctuate. This is normal. Readings between the low and high warning zones indicate the normal operating range.

Readings in the low warning zone can occur when a large number of electrical accessories are operating in the vehicle and the engine is left idling for an extended period.

If there is a problem with the battery charging system, a SERVICE BATTERY CHARGING SYSTEM message will appear in the Driver Information Center (DIC) and/or the charging system light comes on. See *Battery Voltage and Charging Messages* on page 5-34 for more information.

However, readings in either warning zone may indicate a possible problem in the electrical system. Have the vehicle serviced as soon as possible.

Safety Belt Reminders

Driver Safety Belt Reminder Light

There is a driver safety belt reminder light on the instrument cluster.



When the vehicle is started, this light flashes and a chime may come on to remind the driver to fasten their safety belt. Then the light stays on solid until the belt is buckled. This cycle may continue several times if the driver remains or becomes unbuckled while the vehicle is moving.

If the driver safety belt is buckled, neither the light nor the chime comes on.

Passenger Safety Belt Reminder Light

There is a passenger safety belt reminder light near the passenger airbag status indicator. See *Passenger Sensing System* on page 3-30.



When the vehicle is started, this light flashes and a chime may come on to remind passengers to fasten their safety belt. Then the light stays on solid until the belt is buckled. This cycle continues several times if the passenger remains or becomes unbuckled while the vehicle is moving.

If the passenger safety belt is buckled, neither the chime nor the light comes on.

The front passenger safety belt reminder light and chime may turn on if an object is put on the seat such as a briefcase, handbag, grocery bag, laptop, or other electronic device. To turn off the reminder light and/or chime, remove the object from the seat or buckle the safety belt.

Airbag Readiness Light

This light shows if there is an electrical problem with the airbag system. The system check includes the airbag sensor(s), passenger sensing system, the pretensioners, the airbag modules, the wiring, and the crash sensing and diagnostic module. For more information on the airbag system, see *Airbag System on page 3-23*.



The airbag readiness light comes on for several seconds when the vehicle is started. If the light does not come on then, have it fixed immediately.

Warning

If the airbag readiness light stays on after the vehicle is started or comes on while driving, it means the airbag system might not be working properly. The airbags in the vehicle might not inflate in a crash, or they could even inflate without a crash. To help avoid injury, have the vehicle serviced right away.

If there is a problem with the airbag system, a Driver Information Center (DIC) message may also come on. See *Airbag System Messages on page 5-41*.

Passenger Airbag Status Indicator

The vehicle has a passenger sensing system. See *Passenger Sensing System on page 3-30* for important safety information. The instrument panel has a passenger airbag status indicator.



United States



Canada and Mexico

When the vehicle is started, the passenger airbag status indicator will light ON and OFF, or the symbol for on and off, for several seconds

as a system check. Then, after several more seconds, the status indicator will light either ON or OFF, or either the on or off symbol to let you know the status of the front outboard passenger frontal airbag.

If the word ON or the on symbol is lit on the passenger airbag status indicator, it means that the front outboard passenger frontal airbag is allowed to inflate.

If the word OFF or the off symbol is lit on the passenger airbag status indicator, it means that the passenger sensing system has turned off the front outboard passenger frontal airbag.

If, after several seconds, both status indicator lights remain on, or if there are no lights at all, there may be a problem with the lights or the passenger sensing system. See your dealer for service.

Warning

If the airbag readiness light ever comes on and stays on, it means that something may be wrong with the airbag system. To help avoid injury to yourself or others, have the vehicle serviced right away. See *Airbag Readiness Light on page 5-16* for more information, including important safety information.

Charging System Light

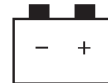

The charging system light comes on briefly when the ignition is turned on, but the engine is not running, as

5-18 Instruments and Controls

a check to show the light is working. It should go out when the engine is started.

If the light stays on, or comes on while driving, there may be a problem with the electrical charging system. Have it checked by your dealer. Driving while this light is on could drain the battery.

When this light comes on, the Driver Information Center (DIC) also displays the SERVICE BATTERY CHARGING SYSTEM message.

See *Vehicle Messages on page 5-34* for more information.

If a short distance must be driven with the light on, be sure to turn off all accessories, such as the radio and air conditioner.

Malfunction Indicator Lamp

A computer system called OBD II (On-Board Diagnostics-Second Generation) monitors the operation of the vehicle to ensure emissions

are at acceptable levels, helping to maintain a clean environment. The malfunction indicator lamp comes on when the vehicle is placed in ON/RUN, as a check to show it is working. If it does not, have the vehicle serviced by your dealer. See *Ignition Positions on page 9-14*.



If the malfunction indicator lamp comes on while the engine is running, this indicates that the OBD II system has detected a problem and diagnosis and service might be required.

Malfunctions often are indicated by the system before any problem is apparent. Being aware of the light can prevent more serious damage to the vehicle. This system also

assists the service technician in correctly diagnosing any malfunction.

Caution

If the vehicle is continually driven with this light on, the emission controls might not work as well, the vehicle fuel economy might not be as good, and the engine might not run as smoothly. This could lead to costly repairs that might not be covered by the vehicle warranty.

Caution

Modifications made to the engine, transmission, exhaust, intake, or fuel system of the vehicle or the replacement of the original tires with other than those of the same Tire Performance Criteria

(Continued)

Caution (Continued)

(TPC) can affect the vehicle's emission controls and can cause this light to come on. Modifications to these systems could lead to costly repairs not covered by the vehicle warranty. This could also result in a failure to pass a required Emission Inspection/Maintenance test. See *Accessories and Modifications on page 10-2*.

This light comes on during a malfunction in one of two ways:

Light Flashing: A misfire condition has been detected. A misfire increases vehicle emissions and could damage the emission control system on the vehicle. Diagnosis and service might be required.

To prevent more serious damage to the vehicle:

- Reduce vehicle speed.

- Avoid hard accelerations.
- Avoid steep uphill grades.
- If towing a trailer, reduce the amount of cargo being hauled as soon as it is possible.

If the light continues to flash, find a safe place to stop and park the vehicle. Turn the vehicle off, wait at least 10 seconds, and restart the engine. If the light is still flashing, follow the previous steps and see your dealer for service as soon as possible.

Light On Steady: An emission control system malfunction has been detected on the vehicle. Diagnosis and service might be required.

The following may correct an emission control system malfunction:

- Check that the fuel cap is fully installed. See *Filling the Tank on page 9-44*. The diagnostic system can determine if the fuel cap has been left off or

improperly installed. A loose or missing fuel cap allows fuel to evaporate into the atmosphere. A few driving trips with the cap properly installed should turn the light off.

- Check that good quality fuel is used. Poor fuel quality causes the engine not to run as efficiently as designed and may cause stalling after start-up, stalling when the vehicle is changed into gear, misfiring, hesitation on acceleration, or stumbling on acceleration. These conditions might go away once the engine is warmed up.

If one or more of these conditions occurs, change the fuel brand used. It may require at least one full tank of the proper fuel to turn the light off.

See *Fuel on page 9-42*.

If none of the above have made the light turn off, your dealer can check the vehicle. The dealer has the proper test equipment and

5-20 Instruments and Controls

diagnostic tools to fix any mechanical or electrical problems that might have developed.

Emissions Inspection and Maintenance Programs

Depending on where you live, your vehicle may be required to participate in an emission control system inspection and maintenance program. For the inspection, the emission system test equipment will likely connect to the vehicle's Data Link Connector (DLC).

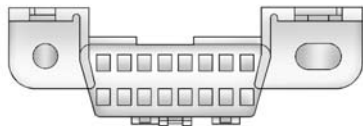

The DLC is under the instrument panel to the left of the steering wheel. See your dealer if assistance is needed.

The vehicle may not pass inspection if:

- The malfunction indicator lamp is on with the engine running, or if the light does not come on when the ignition is turned to ON/RUN while the engine is off. See your dealer for assistance in verifying proper operation of the malfunction indicator lamp.
- The OBD II (On-Board Diagnostics) system determines that critical emission control systems have not been completely diagnosed. The vehicle would be considered not ready for inspection. This can happen if the 12-volt battery has recently been replaced or run down. The diagnostic system is designed to evaluate critical emission control systems during normal driving. This can take several days of routine driving. If this has been done and the vehicle still does not pass the inspection for lack of OBD II

system readiness, your dealer can prepare the vehicle for inspection.

Brake System Warning Light

The vehicle brake system consists of two hydraulic circuits. If one circuit is not working, the remaining circuit can still work to stop the vehicle. For normal braking performance, both circuits need to be working.

If the warning light comes on, there is a brake problem. Have the brake system inspected right away.



BRAKE

Metric

English

This light should come on briefly when the ignition key is turned to ON/RUN. If it does not come on then, have it fixed so it will be ready to warn if there is a problem.

This light may also come on due to low brake fluid. See *Brake Fluid* on page 10-21.

When the ignition is on, the brake system warning light also comes on when the parking brake is set. The light will stay on if the parking brake does not release fully. If it stays on after the parking brake is fully released, it means there is a brake problem.

If the light comes on while driving, pull off the road and stop carefully. Make sure the parking brake is fully released. The pedal may be harder to push or, the pedal may go closer to the floor. It may take longer to stop. If the light is still on, have the vehicle towed for service. See *Towing the Vehicle* on page 10-70.

Warning

The brake system might not be working properly if the brake system warning light is on. Driving with the brake system warning light on can lead to a crash. If the light is still on after the vehicle has been pulled off the road and carefully stopped, have the vehicle towed for service.

The brake message remains on until any DIC button is pressed. The brake light remains on until the problem is fixed. See *Brake System Messages* on page 5-35.

Antilock Brake System (ABS) Warning Light



The ABS warning light comes on briefly when the ignition key is turned to ON/RUN. This is normal. If the light does not come on then, have it fixed so it will be ready to warn you if there is a problem.

If the light stays on, turn the ignition to LOCK/OFF. If the light comes on while driving, stop as soon as possible and turn the ignition off. Then start the engine again to reset the system. If the light still stays on, or comes on again while driving, the vehicle needs service. If the regular brake system warning light is not on, there are still brakes, but no antilock brakes. If the regular brake system warning light is also on,

5-22 Instruments and Controls

there are no antilock brakes and there is a problem with the regular brakes. See *Brake System Warning Light* on page 5-20.

Tow/Haul Mode Light



This light comes on when the Tow/Haul mode has been activated.

For more information, see *Tow/Haul Mode* on page 9-25.

Lane Departure Warning (LDW) Light



This light comes on briefly while starting the vehicle. If it does not, have the vehicle serviced by your dealer. If the system is working normally, the light then turns off.

This light comes on green when the system is on and ready to operate. When the system determines that the vehicle is leaving its lane without using the turn signal, this light will change to amber and flash.

See *Lane Departure Warning (LDW)* on page 9-41.

Vehicle Ahead Indicator



If equipped, this indicator will display green when a vehicle is detected ahead and amber when you are following a vehicle ahead much too closely.

See *Forward Collision Alert (FCA) System* on page 9-32.

StabiliTrak[®] Indicator Light



The StabiliTrak light comes on briefly as the engine is started. If it does not come on, have the vehicle serviced by your dealer.

This light flashes while the StabiliTrak system or the Traction Control System (TCS) is working. The light comes on when there is a problem with the StabiliTrak system. See *Traction Control/Electronic Stability Control* on page 9-28.

Engine Coolant Temperature Warning Light



The engine coolant temperature warning light comes on briefly when the vehicle is started.

If it does not, have the vehicle serviced by your dealer. If the system is working normally, the indicator light then goes off.

If the light comes on and stays on while driving, the vehicle may have a problem with the cooling system. Stop and turn off the vehicle to avoid damage to the engine. A warning chime sounds when this light is on.

See *Engine Overheating* on page 10-16 for more information.

Tire Pressure Light



For vehicles with the Tire Pressure Monitor System (TPMS), this light comes on briefly when the engine is started. It provides information about tire pressures and the TPMS.

When the Light Is On Steady

This indicates that one or more of the tires are significantly underinflated.

A Driver Information Center (DIC) tire pressure message may also display. See *Tire Messages* on page 5-42. Stop as soon as possible, and inflate the tires to the pressure value shown on the Tire and Loading Information label. See *Tire Pressure* on page 10-43.

5-24 Instruments and Controls

When the Light Flashes First and Then Is On Steady

If the light flashes for about a minute and then stays on, there may be a problem with the TPMS. If the problem is not corrected, the light will come on at every ignition cycle. See *Tire Pressure Monitor Operation on page 10-45*.

Engine Oil Pressure Light

Caution

Lack of proper engine oil maintenance can damage the engine. Driving with the engine oil low can also damage the engine. The repairs would not be covered by the vehicle warranty. Check the oil level as soon as possible. Add oil if required, but if the oil level is within the operating range and the oil pressure is still low, have the vehicle serviced. Always follow the maintenance schedule for changing engine oil.



This light should come on briefly as the engine is started. If it does not come on, have the vehicle serviced by your dealer.

If the light comes on and stays on, it means that oil is not flowing through the engine properly. The vehicle could be low on oil and might have some other system problem. See your dealer.

Security Light



The security light should come on briefly as the engine is started. If the system is working normally, the indicator light turns off. If it does not come on, have the vehicle serviced by your dealer.

If the light stays on and the engine does not start, there could be a problem with the theft-deterrent system.

This light is also used to indicate the status of the anti-theft alarm system when the ignition is turned off. The light will flash rapidly if the alarm system is arming and one or more of the monitored entry points is not closed. The light will stay on if the alarm is arming and all entry points are closed.

For information regarding this light and the vehicle's security system, see *Vehicle Alarm System* on page 2-12.

High-Beam On Light



This light comes on when the high-beam headlamps are in use.

See *Headlamp High/Low-Beam Changer* on page 6-2 for more information.

Cruise Control Light



This light comes on when the cruise control is set.

This light goes out when the cruise control is canceled. See *Cruise Control* on page 9-30.

Information Displays

Driver Information Center (DIC) (With DIC Buttons)

If your vehicle has DIC buttons, the information below explains the operation of this system.

The DIC displays information about your vehicle. It also displays warning messages if a system problem is detected.

All messages will appear in the DIC display at the top of the instrument cluster.

The DIC comes on when the ignition is on. After a short delay, the DIC will display the information that was last displayed before the engine was turned off.

The DIC also displays a shift lever position indicator on the bottom line of the display. See *Automatic Transmission* on page 9-22.

5-26 Instruments and Controls

The outside air temperature and compass, if equipped, also display on the DIC when viewing the trip and fuel information. The outside air temperature automatically appears in the top right corner of the DIC display. If there is a problem with the system that controls the temperature display, the numbers will be replaced with dashes. If this occurs, have the vehicle serviced. The compass will be shown in the bottom right corner of the DIC display. See *Compass on page 5-6*.

The DIC also allows some features to be customized. See *Vehicle Personalization (With DIC Buttons) on page 5-45*.

If your vehicle has DIC buttons, you can also use the trip odometer reset stem to view the odometer and trip odometers.

DIC Buttons

The DIC has different displays, which can be accessed by pressing the DIC buttons on the center stack.



The buttons are the set/reset, customization, vehicle information, and trip/fuel buttons. The button functions are detailed in the following pages.

✓ **(Set/Reset):** Press this button to set or reset certain functions and to turn off or acknowledge messages on the DIC.

☒ **(Customization):** Press this button to customize the feature settings on your vehicle. See *Vehicle Personalization (With DIC Buttons) on page 5-45*.

🚗 **(Vehicle Information):** Press this button to display the oil life, park assist on vehicles with this feature, units, tire pressure readings on vehicles with this feature, and compass calibration and zone setting on vehicles with this feature.

📊 **(Trip/Fuel):** Press this button to display the odometer, trip odometers, fuel range, average economy, timer, fuel used, and average speed.

Vehicle Information Menu Items

🚗 **(Vehicle Information):** Press this button to scroll through the following menu items:

OIL LIFE

Press the vehicle information button until OIL LIFE REMAINING displays. This display shows an estimate of the oil's remaining useful life. If you see 99% OIL LIFE REMAINING on the display, that means 99% of the current oil life remains. The engine oil life system will alert you to change the oil on a schedule consistent with your driving conditions.

When the remaining oil life is low, the CHANGE ENGINE OIL SOON message will appear on the display. See *Engine Oil Messages on page 5-37*. You should change the oil as soon as you can. See *Engine Oil on page 10-7*. In addition to the engine oil life system monitoring the oil life, additional maintenance is recommended in the Maintenance Schedule. See *Maintenance Schedule on page 11-2*.

Remember, you must reset the OIL LIFE display yourself after each oil change. It will not reset itself. Also, be careful not to reset the OIL LIFE display accidentally at any time other than when the oil has just been changed. It cannot be reset accurately until the next oil change. To reset the engine oil life system, see *Engine Oil Life System on page 10-9*.

SIDE BLIND ZONE ALERT

If the vehicle has the Side Blind Zone Alert (SBZA) system, this display allows the system to be turned on or off. Once in this display, press the set/reset button to select between ON or OFF. If you choose ON, the system will be turned on. If you choose OFF, the system will be turned off. When the SBZA system is turned off, the DIC will display the SIDE BLIND ZONE ALERT SYSTEM OFF message as a reminder that the system has been turned off. See *Object Detection System Messages on page 5-39* and *Side Blind Zone Alert (SBZA) on page 9-36*.

PARK ASSIST

If your vehicle has the Rear Parking Assist (RPA) system, press the vehicle information button until PARK ASSIST displays. This display allows the system to be turned on or off. Once in this display, press the set/reset button to select between ON or OFF. If you choose ON, the system will be turned on. If you choose OFF, the system will be turned off. The RPA system automatically turns back on after each vehicle start. When the RPA system is turned off and the vehicle is shifted out of P (Park), the DIC will display the PARK ASSIST OFF message as a reminder that the system has been turned off. See *Object Detection System Messages on page 5-39* and *Parking Assist on page 9-34*.

5-28 Instruments and Controls

REAR CROSS TRAFFIC ALERT

If the vehicle has the Rear Cross Traffic Alert (RCTA) system, this display allows the system to be turned on or off. Once in this display, press the set/reset button to select between ON or OFF. If you choose ON, the system will be turned on. If you choose OFF, the system will be turned off. When the RCTA system is turned off, the DIC will display the REAR CROSS TRAFFIC ALERT SYSTEM OFF message as a reminder that the system has been turned off. See *Object Detection System Messages on page 5-39* and *Rear Vision Camera (RVC) on page 9-38*.

UNITS

Press the vehicle information button until UNITS displays. This display allows you to select between metric or English units of measurement. Once in this display, press the set/reset button to select between METRIC or ENGLISH units. All of

the vehicle information will then be displayed in the unit of measurement selected.

FRONT TIRES or REAR TIRES

On vehicles with the Tire Pressure Monitor System (TPMS), the pressure for each tire can be viewed in the DIC. The tire pressure will be shown in either kilopascals (kPa) or pounds per square inch (psi). Press the vehicle information button until the DIC displays FRONT TIRES kPa (PSI) LEFT ## RIGHT ##. Press the vehicle information button again until the DIC displays REAR TIRES kPa (PSI) LEFT ## RIGHT ##.

If a low tire pressure condition is detected by the system while driving, a message advising you to add air to a specific tire will appear in the display. See *Tire Pressure on page 10-43* and *Tire Messages on page 5-42*.

If the tire pressure display shows dashes instead of a value, there may be a problem with your vehicle. If this consistently occurs, see your dealer for service.

COMPASS ZONE SETTING

This display will be available if the vehicle has a compass. See *Compass on page 5-6*.

COMPASS RECALIBRATION

This display will be available if the vehicle has a compass. See *Compass on page 5-6*.

Blank Display

This display shows no information.

Trip/Fuel Menu Items

 (Trip/Fuel): Press this button to scroll through the following menu items:

ODOMETER

Press the trip/fuel button until ODOMETER displays. This display shows the distance the vehicle has been driven in either kilometers (km)

or miles (mi). Pressing the trip odometer reset stem will also display the odometer.

To switch between English and metric measurements, see “UNITS” earlier in this section.

TRIPA and TRIP B

Press the trip/fuel button until TRIPA or TRIP B displays. This display shows the current distance traveled in either kilometers (km) or miles (mi) since the last reset for each trip odometer. Both trip odometers can be used at the same time. Pressing the trip odometer reset stem will also display the trip odometers.

Each trip odometer can be reset to zero separately by pressing the set/reset button or the trip odometer reset stem while the desired trip odometer is displayed.

The trip odometer has a feature called retroactive reset. This can be used to set the trip odometer to the number of kilometers (miles) driven

since the ignition was last turned on. This can be used if the trip odometer is not reset at the beginning of the trip.

To use the retroactive reset feature, press and hold the set/reset button for at least four seconds. The trip odometer will display the number of kilometers (km) or miles (mi) driven since the ignition was last turned on and the vehicle was moving. Once the vehicle begins moving, the trip odometer will accumulate mileage. For example, if the vehicle was driven 8 km (5 mi) before it is started again, and then the retroactive reset feature is activated, the display will show 8 km (5 mi). As the vehicle begins moving, the display will then increase to 8.2 km (5.1 mi), 8.4 km (5.2 mi), etc.

If the retroactive reset feature is activated after the vehicle is started, but before it begins moving, the display will show the number of kilometers (km) or miles (mi) driven during the last ignition cycle.

RANGE

Press the trip/fuel button until RANGE displays. This display shows the approximate number of remaining kilometers (km) or miles (mi) the vehicle can be driven without refueling. The display will show LOW if the fuel level is low.

The fuel range estimate is based on an average of the vehicle’s fuel economy over recent driving history and the amount of fuel remaining in the fuel tank. This estimate will change if driving conditions change. For example, if driving in traffic and making frequent stops, this display may read one number, but if the vehicle is driven on a freeway, the number may change even though the same amount of fuel is in the fuel tank. This is because different driving conditions produce different fuel economies. Generally, freeway driving produces better fuel economy than city driving. Fuel range cannot be reset.

5-30 Instruments and Controls

AVG (Average) ECONOMY

Press the trip/fuel button until AVG ECONOMY displays. This display shows the approximate average liters per 100 kilometers (L/100 km) or miles per gallon (mpg). This number reflects only the approximate average fuel economy that the vehicle has right now, and will change as driving conditions change. This number is calculated based on the number of L/100 km (mpg) recorded since the last time this menu item was reset. To reset AVG ECONOMY, press and hold the set/reset button.

FUEL ECONOMY

Press the trip/fuel button until FUEL ECONOMY displays. The FUEL ECONOMY display shows an approximate estimate of the vehicle fuel economy under a given driving condition at a specific moment. For example, if the vehicle is accelerating and achieving low fuel efficiency this display will show fewer bars, but if the vehicle is

cruising on a flat freeway and getting high fuel efficiency, the display will show more bars. Fuel economy cannot be reset.

TIMER

Press the trip/fuel button until TIMER displays. This display can be used as a timer.

To start the timer, press the set/reset button while TIMER is displayed. The display will show the amount of time that has passed since the timer was last reset, not including time the ignition is off. Time will continue to be counted as long as the ignition is on, even if another display is being shown on the DIC. The timer will record up to 99 hours, 59 minutes and 59 seconds (99:59:59) after which the display will return to zero.

To stop the timer, press the set/reset button briefly while TIMER is displayed.

To reset the timer to zero, press and hold the set/reset button while TIMER is displayed.

FUEL USED

Press the trip/fuel button until FUEL USED displays. This display shows the number of liters (L) or gallons (gal) of fuel used since the last reset of this menu item. To reset the fuel used information, press and hold the set/reset button while FUEL USED is displayed.

AVG (Average) SPEED

Press the trip/fuel button until AVG SPEED displays. This display shows the average speed of the vehicle in kilometers per hour (km/h) or miles per hour (mph). This average is calculated based on the various vehicle speeds recorded since the last reset of this value. To reset the value to zero, press and hold the set/reset button.

Blank Display

This display shows no information.

Driver Information Center (DIC) (Without DIC Buttons)

If your vehicle does not have DIC buttons, the information below explains the operation of this system.

The DIC has different displays, which can be accessed by pressing the trip odometer reset stem on the instrument cluster. Pressing the trip odometer reset stem will also turn off, or acknowledge, DIC messages.

The DIC displays trip and vehicle system information, and warning messages if a system problem is detected.

If your vehicle does not have DIC buttons, you can use the trip odometer reset stem to view the following displays: odometer, trip odometers, oil life, park assist menu for vehicles with the Rear Parking Assist (RPA) system, units, and display language.

If your vehicle has DIC buttons, you can use the trip odometer reset stem to view the following displays: odometer and trip odometers.

Trip Odometer Reset Stem Menu Items

ODOMETER

Press the trip odometer reset stem until ODOMETER displays. This display shows the distance the vehicle has been driven in either kilometers (km) or miles (mi).

To switch between English and metric measurements, see “UNITS” later in this section.

TRIP A or TRIP B

Press the trip odometer reset stem until TRIP A or TRIP B displays. This display shows the current distance traveled in either kilometers (km) or miles (mi) since the last reset for each trip odometer. Both trip odometers can be used at the same time.

Each trip odometer can be reset to zero separately by pressing and holding the trip odometer reset stem while the desired trip odometer is displayed.

The trip odometer has a feature called the retroactive reset. This can be used to set the trip odometer to the number of kilometers (miles) driven since the ignition was last turned on. This can be used if the trip odometer is not reset at the beginning of the trip.

To use the retroactive reset feature, press and hold the trip odometer reset stem for at least four seconds. The trip odometer will display the number of kilometers (km) or miles (mi) driven since the ignition was last turned on and the vehicle was moving. Once the vehicle begins moving, the trip odometer will accumulate mileage. For example, if the vehicle was driven 8 km (5 mi) before it is started again, and then the retroactive reset feature is activated, the display will show 8 km (5 mi). As the vehicle

5-32 Instruments and Controls

begins moving, the display will then increase to 8.2 km (5.1 mi), 8.4 km (5.2 mi), etc.

If the retroactive reset feature is activated after the vehicle is started, but before it begins moving, the display will show the number of kilometers (km) or miles (mi) driven during the last ignition cycle.

OIL LIFE

To access this display, the vehicle must be in P (Park). Press the trip odometer reset stem until OIL LIFE REMAINING displays. This display shows an estimate of the oil's remaining useful life. If you see 99% OIL LIFE REMAINING on the display, that means 99% of the current oil life remains. The engine oil life system will alert you to change the oil on a schedule consistent with your driving conditions.

When the remaining oil life is low, the CHANGE ENGINE OIL SOON message will appear on the display. See *Engine Oil Messages on page 5-37*. You should change the oil as soon as you can. See *Engine Oil on page 10-7*. In addition to the engine oil life system monitoring the oil life, additional maintenance is recommended in the Maintenance Schedule. See *Maintenance Schedule on page 11-2*.

Remember, you must reset the OIL LIFE display yourself after each oil change. It will not reset itself. Also, be careful not to reset the OIL LIFE display accidentally at any time other than when the oil has just been changed. It cannot be reset accurately until the next oil change. To reset the engine oil life system, see *Engine Oil Life System on page 10-9*.

PARK ASSIST

To access this display, the vehicle must be in P (Park). If your vehicle has the Rear Parking Assist (RPA) system, press the trip odometer reset stem until PARK ASSIST displays. This display allows the system to be turned on or off. Once in this display, press and hold the trip odometer reset stem to select between ON or OFF. If you choose ON, the system will be turned on. If you choose OFF, the system will be turned off. The RPA system automatically turns back on after each vehicle start. When the RPA system is turned off and the vehicle is shifted out of P (Park), the DIC will display the PARK ASSIST OFF message as a reminder that the system has been turned off. See *Object Detection System Messages on page 5-39* and *Parking Assist on page 9-34*.

UNITS

To access this display, the vehicle must be in P (Park). Press the trip odometer reset stem until UNITS displays. This display allows you to select between metric or English units of measurement. Once in this display, press and hold the trip odometer reset stem to select between METRIC or ENGLISH units. All of the vehicle information will then be displayed in the unit of measurement selected.

DISPLAY LANGUAGE

To access this display, the vehicle must be in P (Park). This display allows you to select the language in which the DIC messages will appear. To select a language:

1. Press the trip odometer reset stem until DISPLAY LANGUAGE displays.

2. Continue to press and hold the trip odometer reset stem to scroll through all of the available languages.

The available languages are ENGLISH (default), FRANCAIS (French), ESPANOL (Spanish), and NO CHANGE.

3. Once the desired language is displayed, release the trip odometer reset stem to set your choice.

SIDE BLIND ZONE ALERT

If the vehicle has the Side Blind Zone Alert (SBZA) system, this display allows the system to be turned on or off. Once in this display, press the set/reset button to select between ON or OFF. If you choose ON, the system will be turned on. If you choose OFF, the system will be turned off. When the SBZA system is turned off, the DIC will display the SIDE BLIND ZONE ALERT SYSTEM OFF message as a reminder that the system has been turned off. See *Object Detection System Messages on page 5-39* and *Side Blind Zone Alert (SBZA) on page 9-36*.

REAR CROSS TRAFFIC ALERT

If the vehicle has the Rear Cross Traffic Alert (RCTA) system, this display allows the system to be turned on or off. Once in this display, press the set/reset button to select between ON or OFF. If you choose ON, the system will be turned on. If you choose OFF, the system will be turned off. When the RCTA system is turned off, the DIC will display the REAR CROSS TRAFFIC ALERT SYSTEM OFF message as a reminder that the system has been turned off. See *Object Detection System Messages* on page 5-39 and *Rear Vision Camera (RVC)* on page 9-38.

Vehicle Messages

Messages are displayed on the DIC to notify the driver that the status of the vehicle has changed and that some action may be needed by the driver to correct the condition. Multiple messages may appear one after another.

Some messages may not require immediate action, but you can press any of the DIC buttons on the instrument panel or the trip odometer reset stem on the instrument panel cluster to acknowledge that you received the messages and to clear them from the display.

Some messages cannot be cleared from the DIC display because they are more urgent. These messages require action before they can be cleared. You should take any messages that appear on the display seriously and remember that clearing the messages will only make the messages disappear, not correct the problem.

The following are the possible messages that can be displayed and some information about them.

Battery Voltage and Charging Messages

BATTERY LOW START VEHICLE

This message displays when the system detects that the battery voltage has dropped to a critical level and the engine must be started to avoid a dead battery situation.

BATTERY SAVER ACTIVE

This message displays when the system detects that the battery voltage is dropping below expected levels. The battery saver system starts reducing certain features of the vehicle that you may be able to notice. At the point that the features are disabled, this message is displayed. It means that the vehicle is trying to save the charge in the battery.

Turn off all unnecessary accessories to allow the battery to recharge.

The normal battery voltage range is 11.5 to 15.5 volts.

SERVICE BATTERY CHARGING SYSTEM

On some vehicles, this message displays if there is a problem with the battery charging system. Under certain conditions, the charging system light may also turn on in the instrument cluster. See *Charging System Light on page 5-17*. Driving with this problem could drain the battery. Turn off all unnecessary accessories. Have the electrical system checked as soon as possible. See your dealer.

Brake System Messages

SERVICE BRAKE SYSTEM

This message displays along with the brake system warning light if there is a problem with the brake system. See *Brake System Warning Light on page 5-20*. If this message appears, stop as soon as possible and turn off the vehicle. Restart the vehicle and check for the message on the DIC display. If the message is still displayed or appears again when you begin driving, the brake system needs service as soon as possible. See your dealer.

Cruise Control Messages

CRUISE SET TO XXX

This message displays whenever the cruise control is set. See *Cruise Control on page 9-30* for more information.

Door Ajar Messages

DRIVER DOOR OPEN

This message displays and a chime sounds if the driver door is not fully closed and the vehicle is shifted out of P (Park). Stop and turn off the vehicle, check the door for obstructions, and close the door again. Check to see if the message still appears on the DIC.

HOOD OPEN

On some models, this message displays and a chime sounds if the hood is not fully closed. Stop and turn off the vehicle, check the hood for obstructions, and close the hood again. Check to see if the message still appears on the DIC.

LEFT REAR DOOR OPEN

This message displays and a chime sounds if the driver side rear door is not fully closed and the vehicle is shifted out of P (Park). Stop and turn off the vehicle, check the door for obstructions, and close the door again. Check to see if the message still appears on the DIC.

LIFTGATE OPEN

This message displays and a chime sounds if the liftgate is open while the ignition is in ON/RUN. Turn off the vehicle and check the liftgate. Restart the vehicle and check for the message on the DIC display.

PASSENGER DOOR OPEN

This message displays and a chime sounds if the passenger door is not fully closed and the vehicle is shifted out of P (Park). Stop and turn off the vehicle, check the door for obstructions, and close the door again. Check to see if the message still appears on the DIC.

POWER LIFTGATE OFF

This message displays when the power liftgate has been turned off by pressing the power liftgate button on the center stack.

RIGHT REAR DOOR OPEN

This message displays and a chime sounds if the passenger side rear door is not fully closed and the vehicle is shifted out of P (Park). Stop and turn off the vehicle, check the door for obstructions, and close the door again. Check to see if the message still appears on the DIC.

Engine Cooling System Messages

ENGINE HOT A/C (Air Conditioning) OFF

This message displays when the engine coolant becomes hotter than the normal operating temperature. See *Engine Coolant Temperature Gauge on page 5-14*. To avoid added strain on a hot engine, the air

conditioning compressor automatically turns off. When the coolant temperature returns to normal, the air conditioning compressor turns back on. You can continue to drive your vehicle.

If this message continues to appear, have the system repaired by your dealer as soon as possible to avoid damage to the engine.

ENGINE OVERHEATED IDLE ENGINE

This message displays when the engine coolant temperature is too hot. Stop and allow the vehicle to idle until it cools down. See *Engine Coolant Temperature Gauge on page 5-14*.

See *Overheated Engine Protection Operating Mode on page 10-18* for information on driving to a safe place in an emergency.

ENGINE OVERHEATED STOP ENGINE

This message displays and a continuous chime sounds if the engine cooling system reaches unsafe temperatures for operation. Stop and turn off the vehicle as soon as it is safe to do so to avoid severe damage. This message clears when the engine has cooled to a safe operating temperature.

Engine Oil Messages

CHANGE ENGINE OIL SOON

This message displays when service is required for the vehicle. See your dealer. See *Engine Oil* on page 10-7 and *Maintenance Schedule* on page 11-2.

Acknowledging the CHANGE ENGINE OIL SOON message will not reset the OIL LIFE REMAINING. See "Oil Life" under *Driver Information Center (DIC) (With DIC Buttons)* on page 5-25 or *Driver Information Center (DIC) (Without DIC Buttons)* on page 5-31 and *Engine Oil Life System* on page 10-9.

ENGINE OIL LOW — ADD OIL

On some vehicles, this message displays when the engine oil level may be too low. Check the oil level before filling to the recommended level. If the oil is not low and this message remains on, take the vehicle to your dealer for service. See *Engine Oil* on page 10-7.

OIL PRESSURE LOW STOP ENGINE

This message displays when the vehicle's engine oil pressure is low. The oil pressure light also appears on the instrument cluster. See *Engine Oil Pressure Light* on page 5-24.

Stop the vehicle immediately, as engine damage can result from driving a vehicle with low oil pressure. Have the vehicle serviced by your dealer as soon as possible when this message is displayed.

Engine Power Messages

ENGINE POWER IS REDUCED

This message displays and a chime sounds when the cooling system temperature gets too hot and the engine further enters the engine coolant protection mode. See *Engine Overheating* on page 10-16 for further information.

This message also displays when the vehicle's engine power is reduced. Reduced engine power can affect the vehicle's ability to accelerate. If this message is on, but there is no reduction in performance, proceed to your destination. The performance may be reduced the next time the vehicle is driven. The vehicle may be driven at a reduced speed while this message is on, but acceleration and speed may be reduced. Anytime this message stays on, the vehicle should be taken to your dealer for service as soon as possible.

Fuel System Messages

FUEL LEVEL LOW

This message displays and a chime sounds if the fuel level is low. Refuel as soon as possible. See *Fuel Gauge on page 5-13* and *Fuel on page 9-42* for more information.

TIGHTEN GAS CAP

This message may display along with the check engine light on the instrument cluster if the vehicle's fuel cap is not tightened properly. See *Malfunction Indicator Lamp on page 5-18*. Reinstall the fuel cap fully. See *Filling the Tank on page 9-44*. The diagnostic system can determine if the fuel cap has been left off or improperly installed. A loose or missing fuel cap allows fuel to evaporate into the atmosphere. A few driving trips with the cap properly installed should turn this light and message off.

Key and Lock Messages

REPLACE BATTERY IN REMOTE KEY

This message displays if a Remote Keyless Entry (RKE) transmitter battery is low. The battery needs to be replaced in the transmitter. See "Battery Replacement" under *Remote Keyless Entry (RKE) System Operation on page 2-2*.

Lamp Messages

AUTOMATIC LIGHT CONTROL OFF

This message displays when the automatic headlamps are turned off. This message clears itself after 10 seconds.

AUTOMATIC LIGHT CONTROL ON

This message displays when the automatic headlamps are turned on. This message clears itself after 10 seconds.

TURN SIGNAL ON

This message displays and a chime sounds if a turn signal is left on for 1.2 km (0.75 mi). Move the turn signal lever to the off position.

Object Detection System Messages

FORWARD COLLISION ALERT UNAVAILABLE

This message displays when attempting to activate the Forward Collision Alert (FCA) system when it is temporarily unavailable. The FCA system does not need service.

This message could be due to the camera being blocked. Cleaning the outside of the windshield behind the rearview mirror may correct the issue.

FRT CAMERA BLOCKED CLEAN WINDSHIELD

This message displays when the camera is blocked. Cleaning the outside of the windshield behind the rearview mirror may correct the issue. The Lane Departure Warning

system will not operate. Forward Collision Alert (FCA) may not work or may not work as well.

LANE DEPARTURE SYS UNAVAILABLE

This message displays when attempting to activate the Lane Departure Warning (LDW) system when it is temporarily unavailable. The LDW system does not need service.

This message could be due to the camera being blocked. Cleaning the outside of the windshield behind the rearview mirror may correct the issue.

PARK ASST BLOCKED SEE OWNERS MANUAL

This message displays if there is something interfering with the Rear Parking Assist (RPA) system. See *Parking Assist on page 9-34*.

PARK ASSIST OFF

After the vehicle has been started, this message displays to remind the driver that the RPA system has been turned off. To turn the RPA system back on, see *Parking Assist on page 9-34*.

REAR CROSS TRAFFIC ALERT SYSTEM OFF

If the vehicle has the Rear Cross Traffic Alert (RCTA) system, this message displays when the RCTA system has been turned off. See *Rear Vision Camera (RVC) on page 9-38* and *Driver Information Center (DIC) (With DIC Buttons) on page 5-25* or *Driver Information Center (DIC) (Without DIC Buttons) on page 5-31*.

SERVICE FRONT CAMERA

If this message remains on after continued driving, the vehicle needs service. Do not use the Lane Departure Warning (LDW) and Forward Collision Alert (FCA) features. Take the vehicle to your dealer.

SERVICE PARK ASSIST

This message displays if there is a problem with the Rear Parking Assist (RPA) system. Do not use this system to help you park. See *Parking Assist on page 9-34*. See your dealer for service.

SERVICE SIDE DETECTION SYSTEM

If your vehicle has the Side Blind Zone Alert (SBZA) system and this message displays, both SBZA displays will remain on indicating

there is a problem with the SBZA system. If these displays remain on after continued driving, the system needs service. See your dealer. See *Side Blind Zone Alert (SBZA) on page 9-36*.

SIDE BLIND ZONE ALERT SYSTEM OFF

If your vehicle has the Side Blind Zone Alert (SBZA) system, this message displays when the SBZA system has been turned off. See *Side Blind Zone Alert (SBZA) on page 9-36* and *Driver Information Center (DIC) (With DIC Buttons) on page 5-25* or *Driver Information Center (DIC) (Without DIC Buttons) on page 5-31*.

SIDE DETECTION SYS TEMPORARILY OFF

If your vehicle has the Side Blind Zone Alert (SBZA) system, this message displays when the SBZA system is disabled because the sensor cannot detect vehicles in your blind zone. The sensor may be blocked by mud, dirt, snow, ice, or slush. This message may also display during heavy rain or due to road spray. It may also come on when driving in isolated areas with no guardrails, trees, or road signs and light traffic. Your vehicle does not need service. For cleaning instructions, see "Washing the Vehicle" in *Exterior Care on page 10-74*. See *Side Blind Zone Alert (SBZA) on page 9-36*.

Ride Control System Messages

SERVICE STABILITRAK

This message displays if there is a problem with the StabiliTrak[®] system. If this message appears, try to reset the system. Stop; turn off the engine for at least 15 seconds; then start the engine again. If this message still comes on, it means there is a problem. See your dealer for service. The vehicle is safe to drive, however, you do not have the benefit of StabiliTrak, so reduce your speed and drive accordingly.

SERVICE TRACTION CONTROL

This message displays when there is a problem with the Traction Control System (TCS). When this message is displayed, the system will not limit wheel spin. Adjust your driving accordingly. See your dealer for service. See *Traction Control/Electronic Stability Control on page 9-28* for more information.

TRACTION CONTROL OFF

This message displays when the Traction Control System (TCS) is turned off. Adjust your driving accordingly. See *Traction Control/Electronic Stability Control on page 9-28*.

TRACTION CONTROL ON

This message displays when the Traction Control System (TCS) is turned on. See *Traction Control/Electronic Stability Control on page 9-28*. This message clears itself after 10 seconds.

Airbag System Messages

SERVICE AIR BAG

This message displays if there is a problem with the airbag system. Have your dealer inspect the system for problems. See *Airbag Readiness Light on page 5-16* and *Airbag System on page 3-23* for more information.

Security Messages

SERVICE THEFT DETERRENT SYSTEM

This message displays when there is a problem with the theft-deterrent system. The vehicle may or may not restart so you may want to take the vehicle to your dealer before turning off the engine. See *Immobilizer Operation on page 2-13* for more information.

THEFT ATTEMPTED

This message displays if the content theft-deterrent system has detected a break-in attempt while you were away from your vehicle. See *Vehicle Alarm System on page 2-12* for more information.

Service Vehicle Messages

SERVICE A/C (Air Conditioning) SYSTEM

This message displays when the electronic sensors that control the air conditioning and heating systems are no longer working. Have the climate control system serviced by your dealer if you notice a drop in heating and air conditioning efficiency.

SERVICE POWER STEERING

This message displays when a problem is detected with the power steering system. When this message is displayed, you may notice that the effort required to steer the vehicle increases or feels heavier, but you will still be able to steer the vehicle. Have your vehicle serviced by your dealer immediately.

SERVICE VEHICLE SOON

This message displays when a non-emissions related malfunction occurs. Have the vehicle serviced by your dealer as soon as possible.

STARTING DISABLED SERVICE THROTTLE

This message displays when your vehicle's throttle system is not functioning properly. Have your vehicle serviced by your dealer.

Tire Messages

TIRE LOW ADD AIR TO TIRE

On vehicles with the Tire Pressure Monitor System (TPMS), this message displays when the pressure in one or more of the vehicle's tires is low.

This message also displays LEFT FRT (left front), RIGHT FRT (right front), LEFT RR (left rear), or RIGHT RR (right rear) to indicate the location of the low tire.

The low tire pressure warning light will also come on. See *Tire Pressure Light* on page 5-23.

If a tire pressure message appears on the DIC, stop as soon as you can. Inflate the tires by adding air until the tire pressure is equal to the values shown on the Tire and Loading Information label. See *Tires* on page 10-35, *Vehicle Load Limits* on page 9-9, and *Tire Pressure* on page 10-43.

The DIC also shows the tire pressure values. See *Driver Information Center (DIC) (With DIC Buttons)* on page 5-25 or *Driver Information Center (DIC) (Without DIC Buttons)* on page 5-31.

SERVICE TIRE MONITOR SYSTEM

On vehicles with the Tire Pressure Monitor System (TPMS), this message displays if a part on the TPMS is not working properly. The tire pressure light also flashes and then remains on during the same ignition cycle. See *Tire Pressure Light on page 5-23*. Several conditions may cause this message to appear. See *Tire Pressure Monitor Operation on page 10-45* for more information. If the warning comes on and stays on, there may be a problem with the TPMS. See your dealer.

TIRE LEARNING ACTIVE

This message displays when the Tire Pressure Monitor System (TPMS) is relearning the tire positions on your vehicle. The tire positions must be relearned after rotating the tires or after replacing a tire or sensor. See *Tire Rotation on page 10-49*, *Tire Pressure Monitor System on page 10-44*, and *Tire Pressure on page 10-43* for more information.

Transmission Messages

ALL WHEEL DRIVE OFF

If your vehicle has the All-Wheel Drive (AWD) system, this message displays when there is a temporary condition making the AWD system unavailable. The vehicle will run in 2WD. This could be caused by:

- A compact spare tire on the vehicle
- AWD system overheat

- Loss of wheel or vehicle speed
- Certain other vehicle electrical conditions

This message turns off when the compact spare tire is replaced by a full-size tire, the differential fluid cools or the above conditions are no longer present and the warning message is reset. To reset the warning message manually, turn the ignition off and then back on again after 30 seconds. If the message stays on, see your dealer. See *All-Wheel Drive on page 9-25*.

SERVICE ALL WHEEL DRIVE

This message displays if a problem occurs with the All-Wheel Drive (AWD) system. The vehicle will run in 2WD. This could be caused by:

- An electronics problem
- Worn out or overheated clutch plates
- Various electrical issues

5-44 Instruments and Controls

If this message appears, stop as soon as possible and turn off the ignition for 30 seconds. Restart the vehicle and check for the message on the DIC display. If the message still displays or appears again when you begin driving, the system needs service. See your dealer right away.

SERVICE TRANSMISSION

This message displays when there is a problem with the transmission. See your dealer for service.

TRANSMISSION HOT IDLE ENGINE



Do not drive the vehicle while the transmission fluid is overheating, or the transmission can be damaged. This could lead to costly repairs that would not be covered by the warranty.

This message displays and a chime sounds if the transmission fluid in the vehicle gets hot. Driving with the transmission fluid temperature high can cause damage to the vehicle. Stop the vehicle and let it idle to allow the transmission to cool. This message clears when the fluid temperature reaches a safe level.

Vehicle Reminder Messages

ICE POSSIBLE DRIVE WITH CARE

This message displays when the outside air temperature is cold enough to create icy road conditions. Adjust your driving accordingly.

Vehicle Speed Messages

SPEED LIMITED TO XXX KM/H (MPH)

This message displays when your vehicle speed is limited to 128 km/h (80 mph) because the vehicle detects a problem in the speed variable assist steering system. Have your vehicle serviced by your dealer.

Washer Fluid Messages

WASHER FLUID LOW ADD FLUID

This message displays when the windshield washer fluid is low. Fill the windshield washer fluid reservoir as soon as possible. See *Engine Compartment Overview* on page 10-5 for the location of the windshield washer fluid reservoir. Also, see *Washer Fluid* on page 10-19 for more information.

Vehicle Personalization

Vehicle Personalization (With DIC Buttons)

Your vehicle may have customization capabilities that allow you to program certain features to one preferred setting. Customization features can only be programmed to one setting on the vehicle and cannot be programmed to a preferred setting for two different drivers.

All of the customization options may not be available on your vehicle. Only the options available will be displayed on the DIC.

The default settings for the customization features were set when your vehicle left the factory, but may have been changed from their default state since then.

The customization preferences are automatically recalled.

To change customization preferences, use the following procedure.

Entering the Feature Settings Menu

1. Turn the ignition on and place the vehicle in P (Park).

To avoid excessive drain on the battery, it is recommended that the headlamps are turned off.

2. Press the customization button to enter the feature settings menu.

If the menu is not available, FEATURE SETTINGS AVAILABLE IN PARK will display. Before entering the menu, make sure the vehicle is in P (Park).

Feature Settings Menu Items

The following are customization features that allow you to program settings to the vehicle:

DISPLAY IN ENGLISH

This feature will only display if a language other than English has been set. This feature allows you to change the language in which the DIC messages appear to English.

Press the customization button until the **PRESS ✓ TO DISPLAY IN ENGLISH** screen appears on the DIC display. Press the set/reset button once to display all DIC messages in English.

DISPLAY LANGUAGE

This feature allows you to select the language in which the DIC messages will appear.

Press the customization button until the DISPLAY LANGUAGE screen appears on the DIC display. Press the set/reset button once to access the settings for this feature. Then press the customization button to scroll through the following settings:

ENGLISH (default): All messages will appear in English.

FRANCAIS: All messages will appear in French.

ESPAÑOL: All messages will appear in Spanish.

NO CHANGE: No change will be made to this feature. The current setting will remain.

To select a setting, press the set/reset button while the desired setting is displayed on the DIC.

You can also change the language by pressing the trip odometer reset stem. See “DISPLAY LANGUAGE” under “Driver Information Center (DIC) (Without DIC Buttons)” earlier in this section.

AUTO DOOR LOCK

This feature allows you to select when the doors will automatically lock. See *Automatic Door Locks on page 2-7*.

Press the customization button until AUTO DOOR LOCK appears on the DIC display. Press the set/reset button once to access the settings for this feature. Then press the customization button to scroll through the following settings:

SHIFT OUT OF PARK (default):

The doors will automatically lock when the vehicle is shifted out of P (Park).

AT VEHICLE SPEED: The doors will automatically lock when the vehicle speed is above 13 km/h (8 mph) for three seconds.

NO CHANGE: No change will be made to this feature. The current setting will remain.

To select a setting, press the set/reset button while the desired setting is displayed on the DIC.

AUTO DOOR UNLOCK

This feature allows you to select whether or not to turn off the automatic door unlocking feature. It also allows you to select which doors and when the doors will automatically unlock. See *Automatic Door Locks on page 2-7*.

Press the customization button until AUTO DOOR UNLOCK appears on the DIC display. Press the set/reset button once to access the settings for this feature. Then press the customization button to scroll through the following settings:

OFF: None of the doors will automatically unlock.

DRIVER AT KEY OUT: Only the driver door will unlock when the key is taken out of the ignition.

DRIVER IN PARK: Only the driver door will unlock when the vehicle is shifted into P (Park).

ALL AT KEY OUT: All of the doors will unlock when the key is taken out of the ignition.

ALL IN PARK (default): All of the doors will unlock when the vehicle is shifted into P (Park).

NO CHANGE: No change will be made to this feature. The current setting will remain.

To select a setting, press the set/reset button while the desired setting is displayed on the DIC.

REMOTE DOOR LOCK

This feature allows you to select the type of feedback you will receive when locking the vehicle with the Remote Keyless Entry (RKE) transmitter. You will not receive feedback when locking the vehicle with the RKE transmitter if the doors are open. See *Remote Keyless Entry (RKE) System Operation on page 2-2*.

Press the customization button until REMOTE DOOR LOCK appears on the DIC display. Press the set/reset button once to access the settings

for this feature. Then press the customization button to scroll through the following settings:

OFF: There will be no feedback when you press the lock button on the RKE transmitter.

LIGHTS ONLY: The exterior lamps will flash when you press the lock button on the RKE transmitter.

HORN ONLY: The horn will sound on the second press of the lock button on the RKE transmitter.

HORN & LIGHTS (default): The exterior lamps will flash when you press the lock button on the RKE transmitter, and the horn will sound when the lock button is pressed again within five seconds of the previous command.

NO CHANGE: No change will be made to this feature. The current setting will remain.

To select a setting, press the set/reset button while the desired setting is displayed on the DIC.

REMOTE DOOR UNLOCK

This feature allows you to select the type of feedback you will receive when unlocking the vehicle with the Remote Keyless Entry (RKE) transmitter. You will not receive feedback when unlocking the vehicle with the RKE transmitter if the doors are open. See *Remote Keyless Entry (RKE) System Operation on page 2-2*.

Press the customization button until REMOTE DOOR UNLOCK appears on the DIC display. Press the set/reset button once to access the settings for this feature. Then press the customization button to scroll through the following settings:

LIGHTS OFF: The exterior lamps will not flash when you press the unlock button on the RKE transmitter.

LIGHTS ON (default): The exterior lamps will flash when you press the unlock button on the RKE transmitter.

NO CHANGE: No change will be made to this feature. The current setting will remain.

To select a setting, press the set/reset button while the desired setting is displayed on the DIC.

DELAY DOOR LOCK

This feature allows you to select whether or not the locking of the vehicle's doors and liftgate will be delayed. When locking the doors and liftgate with the power door lock switch and a door or the liftgate is open, this feature will delay locking the doors and liftgate until five seconds after the last door is closed. You will hear three chimes to signal that the delayed locking feature is in use. The key must be out of the ignition for this feature to work. You can temporarily override delayed locking by pressing the power door lock switch twice or the lock button on the RKE transmitter twice. See *Delayed Locking on page 2-7*.

Press the customization button until DELAY DOOR LOCK appears on the DIC display. Press the set/reset button once to access the settings for this feature. Then press the customization button to scroll through the following settings:

OFF: There will be no delayed locking of the vehicle's doors.

ON (default): The doors will not lock until five seconds after the last door or the liftgate is closed.

NO CHANGE: No change will be made to this feature. The current setting will remain.

To select a setting, press the set/reset button while the desired setting is displayed on the DIC.

EXIT LIGHTING

This feature allows you to select the amount of time you want the exterior lamps to remain on when it is dark enough outside. This happens after the key is turned from ON/RUN to LOCK/OFF.

Press the customization button until EXIT LIGHTING appears on the DIC display. Press the set/reset button once to access the settings for this feature. Then press the customization button to scroll through the following settings:

OFF: The exterior lamps will not turn on.

30 SECONDS (default): The exterior lamps will stay on for 30 seconds.

1 MINUTE: The exterior lamps will stay on for one minute.

2 MINUTES: The exterior lamps will stay on for two minutes.

NO CHANGE: No change will be made to this feature. The current setting will remain.

To select a setting, press the set/reset button while the desired setting is displayed on the DIC.

APPROACH LIGHTING

This feature allows you to select whether or not to have the exterior lights turn on briefly during low light periods after unlocking the vehicle using the Remote Keyless Entry (RKE) transmitter.

Press the customization button until APPROACH LIGHTING appears on the DIC display. Press the set/reset button once to access the settings for this feature. Then press the customization button to scroll through the following settings:

OFF: The exterior lights will not turn on when you unlock the vehicle with the RKE transmitter.

ON (default): If it is dark enough outside, the exterior lights will turn on briefly when you unlock the vehicle with the RKE transmitter.

The lights will remain on for 20 seconds or until the lock button on the RKE transmitter is pressed, or the vehicle is no longer off. See *Remote Keyless Entry (RKE) System Operation on page 2-2*.

NO CHANGE: No change will be made to this feature. The current setting will remain.

To select a setting, press the set/reset button while the desired setting is displayed on the DIC.

CHIME VOLUME

This feature allows you to select the volume level of the chime.

Press the customization button until CHIME VOLUME appears on the DIC display. Press the set/reset button once to access the settings for this feature. Then press the customization button to scroll through the following settings:

NORMAL: The chime volume will be set to a normal level.

LOUD: The chime volume will be set to a loud level.

NO CHANGE: No change will be made to this feature. The current setting will remain.

There is no default for chime volume. The volume will stay at the last known setting.

To select a setting, press the set/reset button while the desired setting is displayed on the DIC.

PARK TILT MIRRORS

If your vehicle has this feature, it allows you to select whether or not the outside mirror(s) will automatically tilt down when the vehicle is shifted into R (Reverse). See *Park Tilt Mirrors on page 2-16*.

Press the customization button until PARK TILT MIRRORS appears on the DIC display. Press the set/reset button once to access the settings

for this feature. Then press the customization button to scroll through the following settings:

OFF (default): Neither outside mirror will be tilted down when the vehicle is shifted into R (Reverse).

DRIVER MIRROR: The driver outside mirror will be tilted down when the vehicle is shifted into R (Reverse).

PASSENGER MIRROR: The passenger outside mirror will be tilted down when the vehicle is shifted into R (Reverse).

BOTH MIRRORS: The driver and passenger outside mirrors will be tilted down when the vehicle is shifted into R (Reverse).

NO CHANGE: No change will be made to this feature. The current setting will remain.

To select a setting, press the set/reset button while the desired setting is displayed on the DIC.

EASY EXIT SEAT

If your vehicle has this feature, it allows you to select your preference for the automatic easy exit seat feature. See *Memory Seats on page 3-6*.

Press the customization button until EASY EXIT SEAT appears on the DIC display. Press the set/reset button once to access the settings for this feature. Then press the customization button to scroll through the following settings:

OFF (default): No automatic seat exit recall will occur.

ON: The driver seat will move back when the key is removed from the ignition.

The automatic easy exit seat movement will only occur one time after the key is removed from the ignition. If the automatic movement has already occurred, and you put the key back in the ignition and remove it again, the seat and steering column will stay in the

original exit position, unless a memory recall took place prior to removing the key again.

NO CHANGE: No change will be made to this feature. The current setting will remain.

To select a setting, press the set/reset button while the desired setting is displayed on the DIC.

MEMORY SEAT RECALL

If your vehicle has this feature, it allows you to select your preference for the remote memory seat recall feature. See *Memory Seats on page 3-6*.

Press the customization button until MEMORY SEAT RECALL appears on the DIC display. Press the set/reset button once to access the settings for this feature. Then press the customization button to scroll through the following settings:

OFF (default): No remote memory seat recall will occur.

ON: The driver seat and outside mirrors will automatically move to the stored driving position when the unlock button on the Remote Keyless Entry (RKE) transmitter is pressed.

NO CHANGE: No change will be made to this feature. The current setting will remain.

To select a setting, press the set/reset button while the desired setting is displayed on the DIC.

REMOTE START

If your vehicle has this feature, it allows you to turn the remote start off or on. The remote start feature allows you to start the engine from outside of the vehicle using the Remote Keyless Entry (RKE) transmitter. See *Remote Vehicle Start on page 2-4*.

Press the customization button until REMOTE START appears on the DIC display. Press the set/reset button once to access the settings

for this feature. Then press the customization button to scroll through the following settings:

OFF: The remote start feature will be disabled.

ON (default): The remote start feature will be enabled.

NO CHANGE: No change will be made to this feature. The current setting will remain.

To select a setting, press the set/reset button while the desired setting is displayed on the DIC.

FACTORY SETTINGS

This feature allows you to set all of the customization features back to their factory default settings.

Press the customization button until FACTORY SETTINGS appears on the DIC display. Press the set/reset button once to access the settings

for this feature. Then press the customization button to scroll through the following settings:

RESTORE ALL (default): The customization features will be set to their factory default settings.

DO NOT RESTORE: The customization features will not be set to their factory default settings.

To select a setting, press the set/reset button while the desired setting is displayed on the DIC.

EXIT FEATURE SETTINGS

This feature allows you to exit the feature settings menu.

Press the customization button until FEATURE SETTINGS PRESS ✓ TO EXIT appears in the DIC display. Press the set/reset button once to exit the menu.

If you do not exit, pressing the customization button again will return you to the beginning of the feature settings menu.

Exiting the Feature Settings Menu

The feature settings menu will be exited when any of the following occurs:

- The vehicle is shifted out of P (Park).
- The vehicle is no longer in ON/RUN.
- The trip/fuel or vehicle information DIC buttons are pressed.
- The end of the feature settings menu is reached and exited.
- A 40-second time period has elapsed with no selection made.

Universal Remote System

See *Radio Frequency Statement on page 13-12*.

Universal Remote System Programming



If equipped, these buttons are in the overhead console.

This system can replace up to three remote control transmitters used to activate devices such as garage door openers, security systems, and home automation devices. These instructions refer to a garage door opener, but can be used for other devices.

Do not use the Universal Remote system with any garage door opener that does not have the stop and reverse feature. This includes any garage door opener model manufactured before April 1, 1982.

Read these instructions completely before programming the Universal Remote system. It may help to have another person assist with the programming process.

Keep the original hand-held transmitter for use in other vehicles as well as for future programming. Erase the programming when vehicle ownership is terminated. See "Erasing Universal Remote System Buttons" later in this section.

To program a garage door opener, park outside directly in line with and facing the garage door opener receiver. Clear all people and objects near the garage door.

Make sure the hand-held transmitter has a new battery for quicker and more accurate transmission of the radio-frequency signal.

Programming the Universal Remote System

For questions or help programming the Universal Remote system, call 1-800-355-3515 or see www.homelink.com.

Programming involves time-sensitive actions, and may time out causing the procedure to be repeated.

To program up to three devices:

1. Hold the end of the hand-held transmitter about 3 to 8 cm (1 to 3 in) away from the Universal Remote system buttons with the indicator light in view. The hand-held transmitter was supplied by the manufacturer of the garage door opener receiver.

2. At the same time, press and hold both the hand-held transmitter button and one of the three Universal Remote system buttons to be used to operate the garage door. Do not release either button until the indicator light changes from a slow to a rapid flash. Then release both buttons.

Some garage door openers may require substitution of Step 2 with the procedure under "Radio Signals for Canada and Some Gate Operators" later in this section.

3. Press and hold the newly programmed Universal Remote system button for five seconds while watching the indicator light and garage door activation.
 - If the indicator light stays on continuously or the garage door moves when the button is pressed, then

programming is complete. There is no need to complete Steps 4–6.

- If the indicator light does not come on or the garage door does not move, a second button press may be required. For a second time, press and hold the newly programmed button for five seconds. If the light stays on or the garage door moves, programming is complete.
- If the indicator light blinks rapidly for two seconds, then changes to a solid light and the garage door does not move, continue with programming Steps 4–6.



Learn or Smart Button

4. After completing Steps 1–3, locate the Learn or Smart button inside the garage on the garage door opener receiver. The name and color of the button may vary by manufacturer.
5. Press and release the Learn or Smart button. Step 6 must be completed within 30 seconds of pressing this button.
6. Inside the vehicle, press and hold the newly programmed Universal Remote system button for two seconds, then release it. If the garage door does not move or the lamp on the garage door opener receiver does not

flash, press and hold the same button a second time for two seconds, then release it. Again, if the door does not move or the garage door lamp does not flash, press and hold the same button a third time for two seconds, then release it.

The Universal Remote system should now activate the garage door.

Repeat the process for programming the two remaining buttons.

Radio Signals for Canada and Some Gate Operators

For questions or programming help, call 1-800-355-3515 or see www.homelink.com.

Canadian radio-frequency laws and some U.S. gate operators require transmitter signals to time out or quit after several seconds of transmission. This may not be long

enough for the Universal Remote system to pick up the signal during programming.

If the programming did not work, replace Step 2 under “Programming the Universal Remote System” with the following:

Press and hold the Universal Remote system button while pressing and releasing the hand-held transmitter button every two seconds until the signal has been successfully accepted by the Universal Remote system. The Universal Remote system indicator light will flash slowly at first and then rapidly. Proceed with Step 3 under “Programming the Universal Remote System” to complete.

Universal Remote System Operation

Using the Universal Remote System

Press and hold the appropriate Universal Remote system button for at least one-half second. The indicator light will come on while the signal is being transmitted.

Erasing Universal Remote System Buttons

Erase all programmed buttons when vehicle ownership is terminated.

To erase:

1. Press and hold the two outside buttons until the indicator light begins to flash. This should take about 10 seconds.
2. Release both buttons.

Reprogramming a Single Universal Remote System Button

To reprogram any of the system buttons:

1. Press and hold any one of the buttons. Do not release the button.
2. The indicator light will begin to flash after 20 seconds. Without releasing the button, proceed with Step 1 under "Programming the Universal Remote System."

Lighting

Exterior Lighting

Exterior Lamp Controls	6-1
Headlamp High/Low-Beam Changer	6-2
Flash-to-Pass	6-2
Daytime Running Lamps (DRL)/Automatic Headlamp System	6-2
Delayed Headlamps	6-3
Hazard Warning Flashers	6-3
Turn and Lane-Change Signals	6-4
Fog Lamps	6-4

Interior Lighting

Instrument Panel Illumination Control	6-5
Courtesy Lamps	6-5
Dome Lamps	6-5
Reading Lamps	6-6

Lighting Features

Entry Lighting	6-6
Delayed Entry Lighting	6-7
Delayed Exit Lighting	6-7
Parade Dimming	6-7
Battery Load Management	6-7
Battery Power Protection	6-8

Exterior Lighting

Exterior Lamp Controls

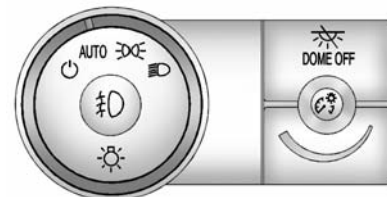

The exterior lamp control is on the instrument panel to the left of the steering wheel.

There are four positions:

⏻ (Off): Briefly turn to this position to turn the automatic light control off or on again.

AUTO (Automatic): Turns the headlamps on automatically at normal brightness, together with the other exterior lamps and instrument panel lights.

6-2 Lighting

 (**Parking Lamps**): Turns on the parking lamps including all lamps, except the headlamps.

 (**Headlamps**): Turns on the headlamps together with the parking lamps and instrument panel lights. A warning chime sounds if the driver door is opened when the ignition switch is off and the headlamps are on.

 (**Fog Lamps**): If equipped, it turns the fog lamps on or off.

See *Fog Lamps* on page 6-4.

Headlamp High/ Low-Beam Changer

 (**Headlamp High/Low-Beam Changer**): Push the turn signal lever away from you to turn the high beams on.

Pull the lever toward you to return to low beams.



This indicator light turns on in the instrument cluster when the high-beam headlamps are on.

Flash-to-Pass

This feature is used to signal to the vehicle ahead that you want to pass.

If the headlamps are off or in the low-beam position, pull the turn signal lever toward you to momentarily switch to high beams.

Release the lever to turn the high-beam headlamps off.

Daytime Running Lamps (DRL)/Automatic Headlamp System

DRL can make it easier for others to see the front of your vehicle during the day. Fully functional DRL are required on all vehicles first sold in Canada.

The DRL system makes the low-beam headlamps come on at a reduced brightness when the following conditions are met:

- The ignition is in the ON/RUN position.
- The exterior lamp control is in AUTO.
- The engine is running.

When the DRL are on, the regular headlamps, taillamps, sidemarker, and other lamps will not be on. The instrument cluster will also not be lit.

The headlamps automatically change from DRL to the regular headlamps depending on the

darkness of the surroundings. The other lamps that come on with the headlamps will also come on.

When it is bright enough outside, the headlamps will go off and the DRL will come on.



When the DRLs are active and a turn signal is operated, the DRL on the side the turn signal is activated, will turn off until the turn signal is turned off.

The regular headlamp system should be turned on when needed.

Do not cover the light sensor on top of the instrument panel because it works with the DRL.



Lights On with Wipers

If the windshield wipers are activated in daylight with the engine on, and the exterior lamp control is in AUTO, the headlamps, parking lamps, and other exterior lamps come on. The transition time for the lamps coming on varies based on wiper speed. When the wipers are

not operating, these lamps turn off. Move the exterior lamp control to  or  to disable this feature.

Delayed Headlamps

Delayed headlamps provide a period of exterior lighting as you leave the area around the vehicle. This feature is activated when the headlamps are on due to the automatic headlamps control feature and when the ignition is turned off. The headlamps remain on until the exterior lamp control is moved to the parking lamps position or until the pre-selected delayed headlamp lighting period has ended.

If the ignition is turned off with the exterior lamp control in the  or  position, the delayed headlamps cycle will not occur.

To disable the delayed headlamps feature or change the time of delay, see *Vehicle Personalization (With DIC Buttons)* on page 5-45.

Hazard Warning Flashers



 **(Hazard Warning Flasher):** Press this button to make the front and rear turn signal lamps flash on and off. This warns others that you are having trouble. Press again to turn the flashers off.

The turn signals do not work while the hazard warning flashers are on.

6-4 Lighting

Turn and Lane-Change Signals

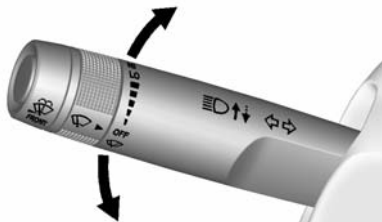

Move the turn signal lever all the way up or down to signal a turn.

An arrow on the instrument cluster flashes in the direction of the turn or lane change.

Raise or lower the lever until the arrow starts to flash to signal a lane change. Hold it there until the lane change is completed. If the lever is briefly pressed and released, the turn signal flashes three times.

The lever returns to its starting position whenever it is released.

If after signaling a turn or lane change the arrow flashes rapidly or does not come on, a signal bulb may be burned out.

Have any burned out bulbs replaced. If a bulb is not burned out, check the fuse. See *Fuses and Circuit Breakers* on page 10-29.

Turn Signal On Chime

If either one of the turn signals is left on and the vehicle has been driven more than 1.2 km (0.75 mi), a chime will sound.

Fog Lamps

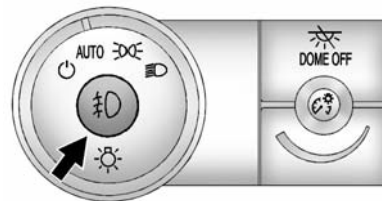

For vehicles with front fog lamps, the fog lamp button is on the exterior lamp control to the left of the steering column.

Use the fog lamps for better vision in foggy or misty conditions.

Fog Lamps: Press the fog lamp button to turn the fog lamps on or off. A light comes on in the instrument cluster when the fog lamps are in use. The ignition must be on for the fog lamps to work.

When the headlamps are changed to high beam, the fog lamps turn off. The fog lamps come back on again when the high-beam headlamps are turned off.

Some localities have laws that require the headlamps to be on along with the fog lamps.

Interior Lighting

Instrument Panel Illumination Control



The instrument panel brightness knob is located on the instrument panel to the left of the steering column.

(Instrument Panel

Brightness): Push the knob in all the way until it extends out and then turn the knob clockwise or

counterclockwise to brighten or dim the lights. Push the knob back in when finished.

Courtesy Lamps

The courtesy lamps automatically come on when a door is opened. The lamps can also be turned on manually by fully turning the instrument panel brightness control clockwise.

The reading lamps, located on the headliner above the rearview mirror, can be turned on or off independently of the automatic courtesy lamps, when the doors are closed.

Dome Lamps

The dome lamps are in the overhead console and above the rear seat passengers.

The dome lamps come on when a door is opened, unless the dome lamp override button is pressed in.

6-6 Lighting

The lamps can also be turned on and off by turning the instrument panel brightness control clockwise to the farthest position.

Dome Lamp Override

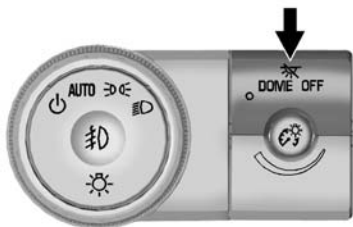

The dome lamp override button is next to the exterior lamps control.

 DOME OFF (Dome Lamp Override): Press the button and the dome lamps remain off when a door is opened. An indicator light on the button comes on to show that

the dome lamps are off. Press the button again so the dome lamps come on when a door is opened.

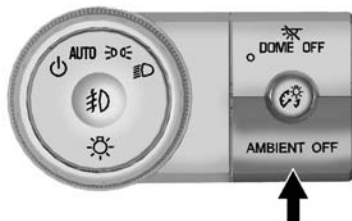

AMBIENT OFF (If Equipped):

Press the button to turn the ambient lights off. Press the button again to turn ambient lights on.

Reading Lamps

Press the button near each lamp to turn them on or off.

Lighting Features

Entry Lighting

For vehicles with courtesy lamps, they come on and stay on for a set time whenever  is pressed on the Remote Keyless Entry (RKE) transmitter.

If a door is opened, the lamps stay on while it is open and then turn off automatically about 20 seconds after the door is closed. If  is pressed and no door is opened, the lamps turn off after about 20 seconds.

Entry lighting includes a feature called theater dimming. With theater dimming, the lamps do not turn off at the end of the delay time. Instead, they slowly dim and then go out. The delay time is canceled if the ignition key is turned to ON/RUN or the power door lock switch is pressed. The lamps will dim right away.

When the ignition is on, illuminated entry is inactive, which means the courtesy lamps will not come on unless a door is opened.

Delayed Entry Lighting

Delayed entry lighting illuminates the interior for a period of time after all the doors have been closed.

The ignition must be off for delayed entry lighting to work. Immediately after all the doors have been closed, the delayed entry lighting feature continues to work until one of the following occurs:

- The ignition is in ON/RUN.
- The doors are locked.
- An illumination period of about 25 seconds has elapsed.

If during the illumination period a door is opened, the timed illumination period is canceled and the interior lamps remain on.

Delayed Exit Lighting

Delayed exit lighting illuminates the interior for a period of time after the key is removed from the ignition.

The ignition must be off for delayed exit lighting to work. When the key is removed, interior illumination activates and remains on until one of the following occurs:

- The ignition is in ON/RUN.
- The power door locks are activated.
- An illumination period of 20 seconds has elapsed.

If during the illumination period a door is opened, the timed illumination period will be canceled and the interior lamps will remain on because a door is open.

Parade Dimming

This feature automatically prohibits the dimming of the instrument panel displays in daylight while the headlamps are on so that the displays are still able to be seen.

Battery Load Management

The vehicle has Electric Power Management (EPM) that estimates the battery's temperature and state of charge. It then adjusts the voltage for best performance and extended life of the battery.

When the battery's state of charge is low, the voltage is raised slightly to quickly bring the charge back up. When the state of charge is high, the voltage is lowered slightly to prevent overcharging. If the vehicle has a voltmeter gauge or a voltage display on the Driver Information Center (DIC), you may see the

6-8 Lighting

voltage move up or down. This is normal. If there is a problem, an alert will be displayed.

The battery can be discharged at idle if the electrical loads are very high. This is true for all vehicles. This is because the generator (alternator) may not be spinning fast enough at idle to produce all of the power needed for very high electrical loads.

A high electrical load occurs when several of the following are on, such as: headlamps, high beams, rear window defogger, climate control fan at high speed, heated seats, engine cooling fans, trailer loads, and loads plugged into accessory power outlets.

EPM works to prevent excessive discharge of the battery. It does this by balancing the generator's output and the vehicle's electrical needs. It can increase engine idle speed to generate more power whenever

needed. It can temporarily reduce the power demands of some accessories.

Normally, these actions occur in steps or levels, without being noticeable. In rare cases at the highest levels of corrective action, this action may be noticeable to the driver. If so, a DIC message might be displayed, such as BATTERY SAVER ACTIVE, BATTERY VOLTAGE LOW, or LOW BATTERY. If one of these messages displays, it is recommended that the driver reduce the electrical loads as much as possible. See *Driver Information Center (DIC) (With DIC Buttons)* on page 5-25 or *Driver Information Center (DIC) (Without DIC Buttons)* on page 5-31.

Battery Power Protection

This feature helps prevent the battery from being drained, if the interior courtesy lamps or reading lamps are accidentally left on. If any of these lamps are left on, they automatically turn off after 10 minutes, if the ignition is off. The lamps will not come back on again until one of the following occurs:

- The ignition is turned on.
- The exterior lamps control is turned off, then on again.

The headlamps will time out after 10 minutes, if they are manually turned on while the ignition is on or off.

Infotainment System

Introduction

Infotainment 7-1
 Theft-Deterrent Feature 7-2
 Overview (Radio without Touchscreen) 7-3
 Overview (Radio with Touchscreen) 7-5
 Operation (Radio without Touchscreen) 7-5
 Operation (Radio with Touchscreen) 7-8

Radio

AM-FM Radio (Radio without Touchscreen) 7-10
 AM-FM Radio (Radio with Touchscreen) 7-12
 Satellite Radio (Radio without Touchscreen) 7-15
 Satellite Radio (Radio with Touchscreen) 7-18
 Radio Reception 7-19
 Multi-Band Antenna 7-19

Audio Players

CD Player (Radio without Touchscreen) 7-20
 CD Player (Radio with Touchscreen) 7-22
 MP3 (Radio without Touchscreen) 7-24
 MP3 (Radio with Touchscreen) 7-29
 Auxiliary Devices 7-31

Rear Seat Infotainment

Rear Seat Audio (RSA) System 7-32

Phone

Bluetooth 7-34

Settings

Settings 7-41

Trademarks and License Agreements

Trademarks and License Agreements 7-43

Introduction

Infotainment

Base radio information is included in this manual. See the infotainment manual for information on other available infotainment systems.

Read the following pages to become familiar with these features.

Warning

Taking your eyes off the road for too long or too often while using any infotainment feature can cause a crash. You or others could be injured or killed. Do not give extended attention to infotainment tasks while driving. Limit your glances at the vehicle displays and focus your attention on driving. Use voice commands whenever possible.

7-2 Infotainment System

The infotainment system has built-in features intended to help avoid distraction by disabling some functions when driving. These functions may gray out when they are unavailable. Many infotainment features are also available through the instrument cluster and steering wheel controls.

Before driving:

- Become familiar with the operation, faceplate buttons, and screen buttons.
- Set up the audio by presetting favorite stations, setting the tone, and adjusting the speakers.

- Set up phone numbers in advance so they can be called easily by pressing a single button or by using a single voice command if equipped with Bluetooth phone capability.

See *Defensive Driving* on page 9-3.

To play the infotainment system with the ignition off, see *Retained Accessory Power (RAP)* on page 9-18.

Theft-Deterrent Feature

TheftLock[®] is designed to discourage theft of the vehicle's radio by learning a portion of the Vehicle Identification Number (VIN). The radio does not operate if it is stolen or moved to a different vehicle.

Overview (Radio without Touchscreen)

For information on using the radio, see *Operation (Radio without Touchscreen)* on page 7-5 or *Operation (Radio with Touchscreen)* on page 7-8.

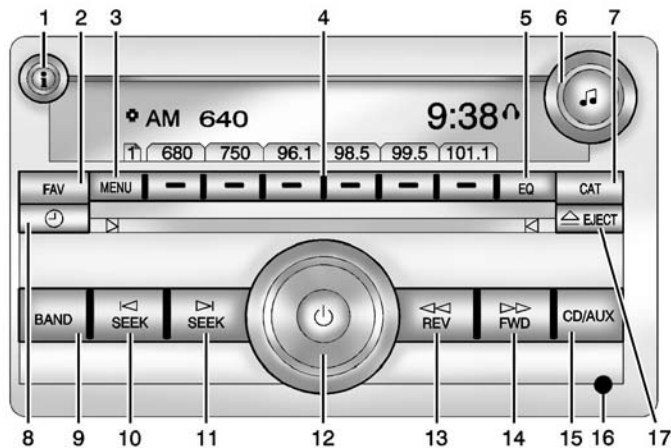

1. i (Information)

- Press to show information on the current station or track.

2. FAV (Favorites Pages)

- Press to scroll through the favorite pages.

3. MENU

- Press to open the tone menu to adjust the bass, midrange, treble, fade, and balance.

4. Buttons 1 - 6

- Saves and selects favorite stations.
- Select options.

5. EQ (Equalizer)

- Press to adjust the equalizer.

6. 🎵 (Tone/Tune)

- Press to set Tone options.
- Turn to manually select radio stations.

7. CAT (Category)

- Press to display a list of SiriusXM® categories.

7-4 Infotainment System

8.  (Clock)

- Press to set the clock.

9. BAND

- Press to scroll through the available bands AM, FM, or SiriusXM if equipped.

10.  SEEK

- Seeks the previous station or track.

11.  SEEK

- Seeks the next station or track.

12.  (Power/Volume)

- Press to turn the infotainment system on or off.
- Turn to adjust the volume.

13.  REV (Reverse)

- Press and hold to go backward fast through a track.

14.  FWD (Forward)

- Press and hold to fast forward through a track.

15. CD/AUX

- Press to scroll through selecting the CD or an auxiliary device.

16. Auxiliary Input Jack

- Use to connect external audio devices.

17.  EJECT

- Press to eject the loaded CD.

Overview (Radio with Touchscreen)

The infotainment system is controlled by using the buttons, touch screen, steering wheel controls, and voice recognition. See *Operation (Radio without Touchscreen)* on page 7-5 or *Operation (Radio with Touchscreen)* on page 7-8.

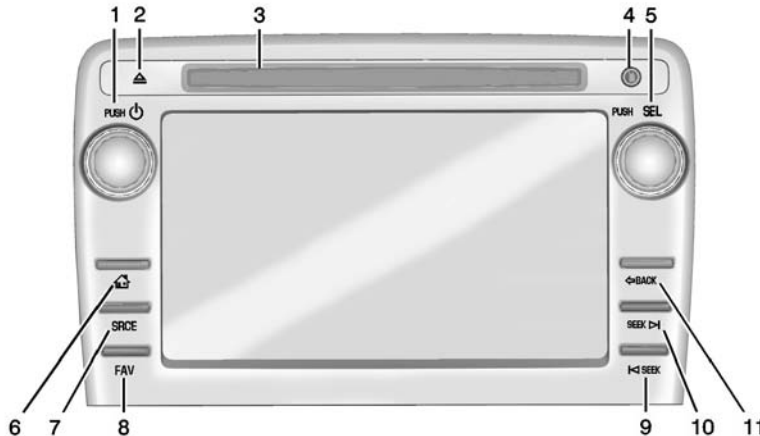

1. PUSH/⏻ (Volume/Power)
2. △ (Eject)

3. CD Slot
4. AUX Port
5. PUSH/SEL (Select)

6. 🏠 (Home Page)
7. SRCE (Source)
8. FAV (Favorites Menu)
9. ⏮ SEEK (Previous/Reverse)
10. SEEK ⏭ (Next/Forward)
11. ⏪ BACK

Operation (Radio without Touchscreen)

Playing the Radio

⏻ (**Power/Volume**): Press to turn the system on and off. Turn to increase or decrease the volume.

A lock symbol displays next to the clock display while the parental control feature is being used. The feature remains on until ⏻ is pressed and held for more than two seconds, or the driver turns the ignition off and exits the vehicle.

7-6 Infotainment System

i (Information): Press to switch the display between the radio station frequency and the time. When the ignition is in the OFF position, press **i** to display the time. For vehicles with XM, MP3, WMA, or RDS features, press **i** to display additional text information related to the current FM-RDS or XM station; or CD, MP3, or WMA song. If information is available during XM, CD, MP3, or WMA playback, the song title information displays on the top line of the display and artist information displays on the bottom line. When information is not available, "NO INFO" displays.

Auto Text (Satellite Radio Service, CD, MP3, and WMA features): If additional information is available for the current song being played, Auto Text will automatically page/scroll the information every five seconds above the FAV presets on the radio display.

To activate Auto Text:

1. Press MENU to display the radio setup menu.
2. Press the softkey under the AUTO TXT tab on the radio display.
3. Press the softkey under the ON tab on the radio display.

If **i** is pressed and the song title or artist information is longer than what can be displayed, the extra information will page every five seconds when Auto Text is activated.

Speed Compensated Volume

(SCV): The SCV feature automatically adjusts the radio volume to compensate for road and wind noise as the vehicle speeds up or slows down, so that the volume level is consistent.

To activate SCV:





1. Set the radio volume.
2. Press the MENU button to display the radio setup menu.

3. Press the softkey under the AUTO VOLUM (automatic volume) tab on the radio display.
4. Press the softkey under the Speed Compensated Volume setting (OFF, Low, Med, or High) to select the level of radio volume compensation. Press the softkey located below the BACK tab on the MENU SETUP display or let the display time out after approximately 10 seconds. Each higher setting allows for more radio volume compensation at faster vehicle speeds.

Setting the Tone (Bass/Midrange/Treble)

BASS/MID/TREB (Bass, Midrange, or Treble): To adjust bass, midrange, or treble:

1. Press  until the tone control tabs display.

2. Continue pressing  to highlight the tab, or press the softkey under the tab.
3. To adjust the highlighted setting, do one of the following until the levels are obtained:
 - Turn  clockwise or counterclockwise.
 - Press  FWD, or  REV.

If a station's frequency is weak or if there is static, decrease the treble.

To quickly adjust bass, midrange, or treble to the middle position, press the softkey under the BASS, MID, or TREB tab for more than two seconds. A beep sounds and the level adjusts to the middle position.

To quickly adjust all tone and speaker controls to the middle position when in the Tone menu, press  for more than two seconds until a beep sounds.



EQ (Equalization): Press to choose bass and treble equalization settings designed for different types of music. The choices are pop, rock, country, talk, jazz, and classical. Selecting MANUAL or changing bass or treble, returns the EQ to the manual bass and treble settings.



Unique EQ settings can be saved for each source.

If the radio has a Bose[®] audio system, the EQ settings are either MANUAL or TALK.

Adjusting the Speakers (Balance/Fade)

BAL/FADE (Balance/Fade): To adjust the balance or fade:

1. Press  until the speaker control tabs display.
2. Continue pressing  to highlight the tab, or press the softkey under the tab.

3. To adjust the highlighted setting, do one of the following until the levels are obtained:
 - Turn  clockwise or counterclockwise.
 - Press  FWD, or  REV.

To quickly adjust balance or fade to the middle position, press the softkey under the BAL or FADE tab for more than two seconds. A beep sounds and the level adjusts to the middle position.

To quickly adjust all speaker and tone controls to the middle position, press  for more than two seconds until a beep sounds.

Radio Messages

Calibration Error: The audio system has been calibrated for the vehicle from the factory. If the message displays, it means that the radio has not been configured properly for the vehicle and it must be returned to your dealer for service.

7-8 Infotainment System

Locked: This message displays when the TheftLock[®] system has locked up the radio. Take the vehicle to your dealer for service.

If any error occurs repeatedly or if an error cannot be corrected, contact your dealer.

Operation (Radio with Touchscreen)

Infotainment Controls

PUSH/ (Volume/Power):

- Press to turn the system on and off.
- Turn to adjust the volume.

 (Eject): Press to eject a disc from the CD player. See *CD Player (Radio with Touchscreen)* on page 7-22 or *CD Player (Radio without Touchscreen)* on page 7-20.

AUX Port: 3.5 mm (1/8 in) connection for external audio devices.

PUSH/SEL(Select):

- Turn to manually find a station or highlight a menu selection.
- Press to select a highlighted selection.

 (Home Page): Press to go to the Home Page. See “Home Page” in this section.

SRCE (Source): Press to switch between AM, FM, CD, and if equipped, SiriusXM[®], front auxiliary, rear auxiliary, and iPod/USB.

Press and hold to mute/pause the system. Press and hold again to unmute/resume the system.

FAV (Favorites Menu): In AM, FM, or SiriusXM, press to change the current favorite page number above the preset buttons. Keep pressing to scroll through the favorites pages. The stored stations for each list display on the bottom of the screen. The number of preset Favorite Pages can be changed by pressing the Settings button on a Home

Page, then pressing Favorites Pages, and then selecting the number of Favorite Pages.

SEEK (Previous/Reverse):

- AM, FM, SiriusXM (if equipped): Press to seek to the previous strong station. Press and hold for Scan. Press  again to stop the scan.
- CD, USB: Press to seek to the beginning of the current or previous track.
- CD, USB: Press and hold to quickly reverse through a track. Release the button to return to playing speed. See *CD Player (Radio with Touchscreen)* on page 7-22 or *CD Player (Radio without Touchscreen)* on page 7-20 and *Auxiliary Devices* on page 7-31.

SEEK \blacktriangleright (Next/Forward):

- AM, FM, SiriusXM (if equipped): Press to seek to the next strong station. Press and hold for Scan. Press \blacktriangleright again to stop the scan.
- CD, USB: Press to seek or skip the next track or program.
- CD, USB: Press and hold to fast forward through a track. Release the button to return to playing speed. See *CD Player (Radio with Touchscreen)* on page 7-22 or *CD Player (Radio without Touchscreen)* on page 7-20 and *Auxiliary Devices* on page 7-31.

\blacktriangleleft **BACK:** Press to return to the previous screen in a menu.

Touchscreen Buttons

Touchscreen buttons show visibly on the screen when available. When a function is unavailable, the button may gray-out. When a function is selected, the button may highlight, or animate.

Home Page

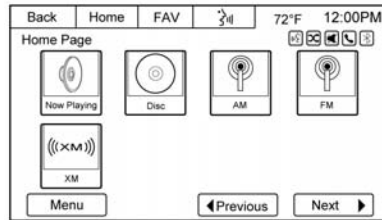

The infotainment system displays a Home Page to access all of the applications.

Back: Press to go back to the previous page or menu.

Home: From any page, press to cycle through the Home Pages to start a different application. The Home Page can have up to three pages with eight icons per page. Each of these three pages can be customized to contain your choice of up to eight per screen. They may also be re-ordered on each screen to taste.

FAV (Favorites): Press to scroll through the favorites banner on the bottom of the screen. The favorites banner stores your favorite radio and SiriusXM stations. To store a favorite station, press and hold on the desired position on the banner until a beep is heard.

w/ **(Voice Recognition):** Press to begin voice recognition. See *Bluetooth* on page 7-34.

Menu: Press to enter the Home Page menu.

\blacktriangleleft **Previous :** Press to go to the previous Home Page.

Next \blacktriangleright : Press to go to the next Home Page.

Home Page Features

Some features are disabled when the vehicle is moving and some icons may not be active.

Now Playing: Press to display the active source page. The sources available are AM, FM, XM (if equipped), CD, USB, Bluetooth, or AUX Input.

Settings: Press to display the Settings menu. See *Settings on page 7-41*.

Tone: Press to display the Tone Settings menu. The following may display:

Tone Settings: Press to adjust the tone settings. The following may display:

- EQ: Press ◀ or ▶ to adjust the equalizer.
- Bass: Press + or - to adjust the bass.
- Middle: Press + or - to adjust the middle.
- Treble: Press + or - to adjust the treble.
- Balance: Press L to hear more sound from the left speakers or R for more sound from the right

speakers. The middle position balances the sound between the left and right speakers.

- Fade: Press F for more sound from the front speakers or R for more sound from the rear speakers. The middle position balances the sound between the front and rear speakers.

DSP Mode: Press ◀ or ▶ to adjust the DSP mode (if equipped).

Language

To change the language of the screens. See *Vehicle Personalization (With DIC Buttons) on page 5-45*.

English or Metric Units

To change the screens from English or metric. See *Driver Information Center (DIC) (With DIC Buttons) on page 5-25* or *Driver Information Center (DIC) (Without DIC Buttons) on page 5-31*.

Radio

AM-FM Radio (Radio without Touchscreen)

Radio Data System (RDS)

The RDS feature is available for use only on FM stations that broadcast RDS information. This system relies upon receiving specific information from these stations and only works when the information is available. While the radio is tuned to an FM-RDS station, the station name or call letters display. In rare cases, a radio station could broadcast incorrect information that causes the radio features to work improperly. If this happens, contact the radio station.

Finding a Station

BAND: Press to switch between AM, FM, or SiriusXM[®]. The selection displays.

♪ (Tune): Turn to select radio stations.

⏪ **SEEK** and ⏩ **SEEK**: Press to go to the previous or next station and stay there.

To scan stations, press and hold ⏪ **SEEK** or ⏩ **SEEK** until a beep sounds. The radio goes to a station, plays for a few seconds, then goes to the next station. Press either arrow again to stop scanning.

The radio only seeks and scans stations with a strong signal that are in the selected band.

Storing a Radio Station as a Favorite

Drivers are encouraged to set up their radio station favorites while the vehicle is in P (Park). Tune to favorite stations using the presets, favorites button, and steering wheel controls. See *Steering Wheel Controls (Radio with Touchscreen)* on page 5-3 or *Steering Wheel Controls (Radio without Touchscreen)* on page 5-2.

FAV (Favorites): A maximum of 36 stations can be programmed as favorites using the six softkeys below the radio station frequency tabs and by using the radio favorites page button (FAV button). Press to go through up to six pages of favorites, each having six favorite stations available per page. Each page of favorites can contain any combination of AM, FM, or SiriusXM stations.

The balance/fade and tone settings that were previously adjusted are stored with the favorite stations.

To store a station as a favorite:

1. Tune to the desired radio station.
2. Press FAV to display the page to store the station.
3. Press and hold one of the six softkeys until a beep sounds. When that softkey is pressed and released, the station that was set returns.

4. Repeat the steps for each radio station to be stored as a favorite.

To set up the number of favorites pages:

1. Press MENU to display the radio setup menu.
2. Press the softkey below the FAV 1-6 tab.
3. Select the desired number of favorites pages by pressing the softkey below the displayed page numbers.
4. Press FAV, or let the menu time out, to return to the original main radio screen showing the radio station frequency tabs and to begin the process of programming favorites for the chosen number of favorites pages.

AM-FM Radio (Radio with Touchscreen)

Playing the Radio

PUSH/⏻ (Power/Volume):

- Press to turn the radio on or off.
- Turn to increase or decrease the volume of the active source.

The steering wheel controls can also be used to adjust the volume. See *Steering Wheel Controls (Radio with Touchscreen)* on page 5-3 or *Steering Wheel Controls (Radio without Touchscreen)* on page 5-2.

Audio Source

To access AM, FM, or SiriusXM® if equipped, do one of the following:

- Press the AM, FM, or XM (if equipped) screen button on the Home Page.
- Press the SRCE radio button to scroll through the options. A source ribbon will appear at

the bottom of the screen allowing you to select the one you want.

Infotainment System Settings

Tone Settings

To access the tone settings, press the Tone Settings button on the Home Page.

To adjust the settings:

- Bass: Press + or – to change the level.
- Middle: Press + or – to change the level.
- Treble: Press + or – to change the level.
- EQ: Press ◀ or ▶ to scroll through the preset EQ options.
- DSP Mode: Press ◀ or ▶ to scroll through the preset DSP modes.
- Fade: Press the F or R button for more sound from the front or rear speakers. The middle

position balances the sound between the front and rear speakers.

- Balance: Press the L or R button for more sound from the left or right speakers. The middle position balances the sound between the left and right speakers.

Finding a Station

Press SRCE to select AM, FM, or SiriusXM (if equipped).

Turn the PUSH/SEL knob to find a radio station. To select a preset station, press FAV to scroll through the favorite pages and then press a preset button on the radio or the screen button.

Seeking a Station

Press ⏪ SEEK or SEEK ⏩ to search for a station. You may also use the ⏪ on the steering wheel controls.

AM

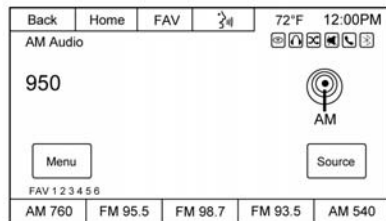

To access the AM menu press the Menu screen button and the following may display:

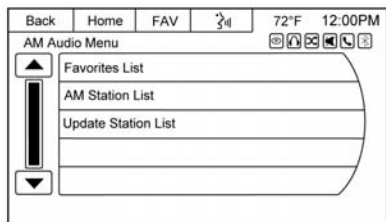

Favorites List: Press to display the favorites list.

AM Station List: Press to display a list of AM stations.

Update Station List: Press to update the AM stations list.

FM

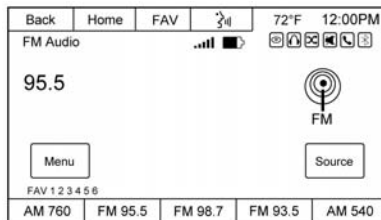

To access the FM Menu press the Menu screen button and the following may display:

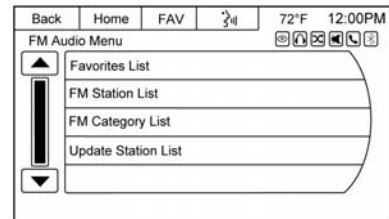

Favorites List: Press to display the favorites list.

FM Station List: Press to display a list of FM stations.

FM Category List: Press to display a list of FM categories.

Update Station List: Press to update the FM stations list.

7-14 Infotainment System

SiriusXM (If Equipped)

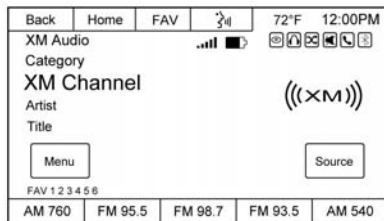

To access the XM Menu press the Menu screen button and the following may display:

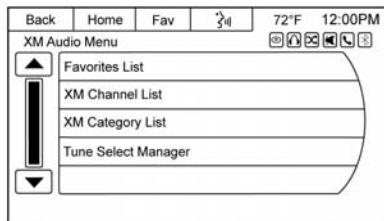

Favorites List: Press to display the favorites list.

XM Channel List: Press to display a list of SiriusXM channels.

XM Category List: Press to display a list of SiriusXM categories.

Tune Select: If equipped with SiriusXM, press and the following may display:

- **Artist:** Press to set an audio alert when the current artist is playing on a SiriusXM channel.
- **Song:** Press to set an audio alert when the current song is playing on a SiriusXM channel.
- **Tune Select Manager:** Press Disable/Enable All Alerts to enable or disable all alerts. A checkmark next to the alert means it is turned on. Press an alert to turn it off. Press Delete to delete an alert.
- **Audible Alert:** This feature will give an audio alert when certain artists or songs are available on a specific station. Press to turn on or off.

Storing Radio Station Presets

Up to 30 preset stations can be stored. AM, FM, and SiriusXM (if equipped) can be mixed.

1. From the AM, FM, or SiriusXM main page, press and hold any 1–5 buttons or one of the preset screen buttons on the banner until a beep is heard. The new preset information displays on that screen button.
2. Repeat for each preset.

Mixed-Band Presets

Each favorite page can store five preset stations. The presets within a page can be from different radio bands.

To scroll through the pages, press FAV or the FAV screen button on the top bar. The current page number displays above the preset buttons. The stored stations for each favorite page display on the preset buttons.

To change the number of favorite pages displayed:

1. Press Settings on the Home Page.
2. Press Favorite Pages.
3. Select the number of pages to display.

Recalling a Preset Station

To recall a preset station from a favorites page, do one the following:

- Press the FAV screen button at the top bar to display the preset pop-up. Press one of the preset screen buttons to go to the selected preset station.
- In the AM, FM, or SiriusXM (if equipped) main page, press one of the preset screen buttons to go to the selected preset station.

Satellite Radio (Radio without Touchscreen)

SiriusXM® Satellite Radio Service

If equipped, SiriusXM is a satellite radio service based in the 48 contiguous United States and 10 Canadian provinces. SiriusXM Satellite Radio has a wide variety of programming and commercial-free music, coast to coast, and in digital-quality sound. A service fee is required to receive the SiriusXM service. If SiriusXM Service needs to be reactivated, the radio will display “No Subscription Please Renew” on channel XM1. For more information, contact SiriusXM at www.siriusxm.com or 1-866-635-2349 (U.S) and www.xmradio.ca or call 1-877-209-0079 (Canada).

Finding a Station

BAND: Press to switch between AM, FM, or SiriusXM. The selection displays.

🎵 (Tune): Turn to select radio stations.

⏪ SEEK and ⏩ SEEK: Press to go to the previous or next station and stay there.

To scan stations, press and hold ⏪ or ⏩ until a beep sounds. The radio goes to a station, plays for a few seconds, then goes to the next station. Press either arrow again to stop scanning.

The radio only seeks and scans stations with a strong signal that are in the selected band.

Finding a Category (CAT) Station

CAT (Category): Press to find SiriusXM stations when the radio is in the XM mode. To find SiriusXM channels within a desired category:

1. Press BAND until the SiriusXM frequency displays.
2. Press CAT to display the category tabs.

7-16 Infotainment System

- Continue pressing CAT until the desired category name displays.
 - Radios with CD can also navigate the category list by pressing \triangleleft REV or \triangleright FWD.
- Press either of the two buttons below the desired category tab to immediately tune to the first SiriusXM station associated with that category.
- To go to the next or previous SiriusXM station within the selected category, do one of the following:
 - Turn \mathbb{J} .
 - Press the buttons below the right or left arrows on the display.
 - Press either SEEK arrow.
- To exit the category search mode, press the FAV button or BAND button to display the favorites again.

Undesired SiriusXM categories can be removed through the setup menu. To remove an undesired category, perform the following:

- Press MENU to display the radio setup menu.
- Press the softkey below the XM CAT tab.
- Turn \mathbb{J} to display the category to be removed.
- Press the softkey under the Remove tab until the category name along with the word Removed displays.
- Repeat the steps to remove more categories.

Removed categories can be restored by pressing the softkey under the Add tab when a removed category is displayed or by pressing the softkey under the Restore All tab.

Categories cannot be removed or added while the vehicle is moving faster than 8 km/h (5 mph).

Storing a Radio Station as a Favorite

Drivers are encouraged to set up their radio station favorites while the vehicle is in P (Park). Tune to favorite stations using the presets, favorites button, and steering wheel controls. See *Steering Wheel Controls (Radio with Touchscreen)* on page 5-3 or *Steering Wheel Controls (Radio without Touchscreen)* on page 5-2.

FAV (Favorites): A maximum of 36 stations can be programmed as favorites using the six softkeys below the radio station frequency tabs and by using the radio favorites page button (FAV button). Press to go through up to six pages of favorites, each having six favorite stations available per page. Each page of favorites can contain any combination of AM, FM, or SiriusXM stations.

The balance/fade and tone settings that were previously adjusted are stored with the favorite stations.

To store a station as a favorite:

1. Tune to the desired radio station.
2. Press FAV to display the page to store the station.
3. Press and hold one of the six softkeys until a beep sounds. When that softkey is pressed and released, the station that was set returns.
4. Repeat the steps for each radio station to be stored as a favorite.

To set up the number of favorites pages:

1. Press MENU to display the radio setup menu.
2. Press the softkey below the FAV 1-6 tab.
3. Select the desired number of favorites pages by pressing the softkey below the displayed page numbers.
4. Press FAV, or let the menu time out, to return to the original main radio screen showing the radio station frequency tabs and to

begin the process of programming favorites for the chosen number of favorites pages.

SiriusXM Radio Messages

XL (Explicit Language Channels): These channels, or any others, can be blocked at a customer's request, by calling 1-866-635-2349 (U.S) and 1-877-209-0079 (Canada).

XM Updating: The encryption code in the receiver is being updated, and no action is required. This process should take no longer than 30 seconds.

No XM Signal: The system is functioning correctly, but the vehicle is in a location that is blocking the SiriusXM signal. When the vehicle is moved into an open area, the signal should return.

Loading XM: The audio system is acquiring and processing audio and text data. No action is needed. This message should disappear shortly.

Channel Off Air: This channel is not currently in service. Tune in to another channel.

Channel Unauth: This channel is blocked or cannot be received with your SiriusXM subscription package.

Channel Unavail: This previously assigned channel is no longer assigned. Tune to another station. If this station was one of the presets, choose another station for that preset button.

No Artist Info: No artist information is available at this time on this channel. The system is working properly.

No Title Info: No song title information is available at this time on this channel. The system is working properly.

No CAT Info: No category information is available at this time on this channel. The system is working properly.

No Information: No text or informational messages are available at this time on this channel. The system is working properly.

No Subscription Please Renew: SiriusXM subscription needs to be reactivated. Contact SiriusXM at www.siriusxm.com or 1-866-635-2349 (U.S.) and www.xmradio.ca or call 1-877-209-0079 (Canada).

CAT Not Found: There are no channels available for the selected category. The system is working properly.

XM Theftlocked: The XM receiver in the vehicle could have previously been in another vehicle. For security purposes, XM receivers cannot be swapped between vehicles. If this message is received after having the vehicle serviced, check with your dealer.

XM Radio ID: If tuned to channel 0, this message alternates with the XM Radio eight-digit radio ID label. This label is needed to activate the service.

Unknown: If this message is received when tuned to channel 0, there could be a receiver fault. Consult with your dealer.

Check XM Receiver: If this message does not clear within a short period of time, the receiver could have a fault. Consult with your dealer.

XM Not Available: If this message does not clear within a short period of time, the receiver could have a fault. Consult with your dealer.

Satellite Radio (Radio with Touchscreen)

If equipped, vehicles with a valid SiriusXM[®] satellite radio subscription can receive SiriusXM programming.

SiriusXM satellite radio has a wide variety of programming and commercial-free music, coast to coast, and in digital-quality sound. For more information, see www.siriusxm.com or call 1-866-635-2349 (U.S.) and www.xmradio.ca or call 1-877-209-0079 (Canada).

When SiriusXM is active, the station name, number, category name, song title, and artist display on the screen. SiriusXM may update the background picture at any time.

SiriusXM Categories

SiriusXM stations are organized in categories.

Adding or Removing SiriusXM Categories

Using the home page:

1. Press the Settings screen button on the Home Page.
2. Select XM Categories.

3. Select or deselect a category. A checkmark will indicate that the category is selected.

Press “Show All XM Categories” to restore all SiriusXM categories.

Radio Reception

Frequency interference and static can occur during normal radio reception if items such as phone chargers, vehicle convenience accessories, and external electronic devices are plugged into the accessory power outlet. If there is interference or static, unplug the item from the accessory power outlet.

FM

FM signals only reach about 16 to 65 km (10 to 40 mi). Although the radio has a built-in electronic circuit that automatically works to reduce interference, some static can occur, especially around tall buildings or hills, causing the sound to fade in and out.

AM

The range for most AM stations is greater than for FM, especially at night. The longer range can cause station frequencies to interfere with each other. Static can also occur when things like storms and power lines interfere with radio reception. When this happens, try reducing the treble on the radio.

SiriusXM Satellite Radio Service

If equipped, SiriusXM Satellite Radio Service provides digital radio reception. Tall buildings or hills can interfere with satellite radio signals, causing the sound to fade in and out. In addition, traveling or standing under heavy foliage, bridges, garages, or tunnels may cause loss of the SiriusXM signal for a period of time.

Cell Phone Usage

Cell phone usage, such as making or receiving phone calls, charging, or just having the phone on may

cause static interference in the radio. Unplug the phone or turn it off if this happens.

Multi-Band Antenna

The multi-band antenna is located on the roof of the vehicle. This type of antenna is used with the AM/FM radio, as well as OnStar and the SiriusXM Satellite Radio Service System, if the vehicle has these features. Keep this antenna clear of snow and ice build up for clear radio reception. If the vehicle has a sunroof, the performance of the radio system may be affected if the sunroof is open. Loading items onto the roof of the vehicle can interfere with the performance of the radio system and, if the vehicle has this feature, OnStar. Make sure the multi-band antenna is not obstructed.

Audio Players



CD Player (Radio without Touchscreen)

Playing a CD

Insert a CD partway into the slot, label side up. The player pulls it in and the CD should begin playing.

 **EJECT:** Press and release to eject the disc that is currently playing. A beep sounds and Ejecting Disc displays. Once the disc is ejected, Remove Disc displays. The disc can be removed. If the disc is not removed, after several seconds, the disc automatically pulls back into the player.

 **(Tune):** Turn to select tracks on the CD that is currently playing.

 **SEEK or**  **SEEK:** Press  SEEK to go to the start of the current track, if more than 10 seconds on the track have

played, otherwise goes to the previous track. Press  SEEK to go to the next track.

If either arrow is held, or pressed multiple times, the player continues moving backward or forward through the tracks on the CD.

 **REV (Fast Reverse):** Press and hold to reverse playback quickly within a track. Sound will be heard at a reduced volume. Release to resume playing the track. The elapsed time of the track displays.

 **FWD (Fast Forward):** Press and hold to advance playback quickly within a track. Sound will be heard at a reduced volume. Release to resume playing the track. The elapsed time of the track displays.

RDM (Random): CD tracks can be listened to in random, rather than sequential order with the random setting. To use random, press the softkey under the RDM label until Random Current Disc displays. Press the softkey again to turn off random play.

BAND: Press to listen to the radio when a CD is playing. The CD remains inside the radio for future listening.

CD/AUX (CD/Auxiliary): Press to select between CD, Auxiliary, or USB.

- When a CD is in the player, the CD icon and a message showing the disc and/or track number display.
- If an auxiliary input device is not connected or a CD is not installed an error message will display.

Care of CDs

If playing a CD-R, the sound quality can be reduced due to CD-R or CD-RW quality, the method of recording, the quality of the music that has been recorded, and the way the CD-R or CD-RW has been handled. Handle them carefully. Store CD-R(s) or CD-RW(s) in their original cases or other protective cases and away from direct sunlight

and dust. The CD player scans the bottom surface of the disc. If the surface of a CD is damaged, such as cracked, broken, or scratched, the CD does not play properly or not at all. Do not touch the bottom side of a CD while handling it; this could damage the surface. Pick up CDs by grasping the outer edges or the edge of the hole and the outer edge.

If the surface of a CD is soiled, take a soft, lint-free cloth or dampen a clean, soft cloth in a mild, neutral detergent solution mixed with water, and clean it. Make sure the wiping process starts from the center to the edge.

Care of the CD Player

Do not add any label to a CD; it could get caught in the CD player. If a CD is recorded on a personal computer and a description label is needed, try labeling the top of the recorded CD with a marking pen.

The use of CD lens cleaners for CDs is not advised.

Caution

If a label is added to a CD, more than one CD is inserted into the slot at a time, or an attempt is made to play scratched or damaged CDs, the CD player could be damaged. While using the CD player, use only CDs in good condition without any label, load one CD at a time, and keep the CD player and the loading slot free of foreign materials, liquids, and debris.

If an error displays, see “CD Messages” later in this section.

Playing an MP3/WMA CD-R or CD-RW Disc

The radio has the capability of playing an MP3/WMA CD-R or CD-RW disc. For more information on how to play an MP3/WMA CD-R or CD-RW disc, see *MP3 (Radio with Touchscreen)* on page 7-29 or *MP3 (Radio without Touchscreen)* on page 7-24.

CD Messages

Check Disc: Radios with a single CD player display Check Disc and/or eject the CD if an error occurs.

Optical Error: The disc was inserted upside down.

Disk Read Error: A disc was inserted with an invalid or unknown format.

Player Error: There are disc LOAD or disc EJECT problems.

- It is very hot. When the temperature returns to normal, the CD should play.

7-22 Infotainment System

- The road is very rough. When the road becomes smoother, the CD should play.
- The CD is dirty, scratched, wet, or upside down.
- The air is very humid. If so, wait about an hour and try again.
- There was a problem while burning the CD.
- The label is caught in the CD player.

If the CD is not playing correctly for any other reason, try a known good CD.

If any error occurs repeatedly or if an error cannot be corrected, contact your dealer. If the radio displays an error message, write it down and provide it to your dealer when reporting the problem.

CD Player (Radio with Touchscreen)

The player can be used for CD and MP3 audio.

With the vehicle on, insert a disc into the slot, label side up. The player pulls it in and begins playing.

The system is capable of playing:

- Most audio CDs
- CD-R
- CD-RW
- MP3 or unprotected WMA formats

When playing any compatible recordable disc, the sound quality can be reduced due to disc quality, the method of recording, the quality of the music that has been recorded, or the way the disc has been handled.

There can be increased skipping, difficulty in recording tracks, difficulty in finding tracks, and/or difficulty in loading and ejecting. If these problems occur, check the disc for damage or try a known good disc.

To avoid damage to the CD player:

- Do not use scratched or damaged discs.
- Do not apply labels to discs. The labels could get caught in the player.
- Insert only one disc at a time.
- Keep the loading slot free of foreign materials, liquids, and debris.
- Use a marking pen to label the top of the disc.

Loading and Ejecting Discs

To load a disc:

1. Turn the radio on.
2. Insert a disc into the slot, label side up. The player pulls it in the rest of the way. If the disc is damaged or improperly loaded, there is an error and the disc ejects.

The disc automatically plays once loaded.

Press  to eject a disc from the CD player. If the disc is not removed within a short period of time, it is automatically pulled back into the player.

Playing an Audio CD

Make sure a disc is inserted in the player.

1. Press the Disc screen button on the Home Page or from the SRCE/Source banner.
2. Press the Menu screen button on the CD Audio screen to display a list of Tracks/Songs.
3. Press the desired track/song.

On the Disc main page a track number displays at the beginning of each track. Song, Artist, Elapsed Time, and Album information displays when available.

Use the following controls to play the disc:

SEEK:

- Press to seek to the beginning of the current or previous track. If the track has been playing for less than eight seconds, it seeks to the previous track. If longer than eight seconds, the current track starts from the beginning.
- Press and hold to fast reverse through a track. Release the button to return to playing speed. Elapsed time displays.

SEEK

- Press to seek to the next track.
- Press and hold to fast forward through a track. Release the button to return to playing speed. Elapsed time displays.

PUSH/SEL (Select): Turn to the right or left to select the next or previous track.

Error Messages

If Disc Error displays and/or the disc comes out, it could be for one of the following reasons:

- The disc has an invalid or unknown format.
- The disc is very hot. Try the disc again when the temperature returns to normal.
- The road is very rough. Try the disc again when the road is smoother.
- The disc is dirty, scratched, wet, or upside down.
- The air is very humid. Try the disc again later.
- There was a problem while burning the disc.
- The label is caught in the player.

If the CD is not playing correctly, for any other reason, try a known good CD.

If any error continues, contact your dealer.

MP3 (Radio without Touchscreen)

Format

Radios that have the capability of playing MP3s can play .mp3 or .wma files that were recorded onto a CD-R or CD-RW disc. The files can be recorded with the following fixed bit rates: 32 kbps, 40 kbps, 56 kbps, 64 kbps, 80 kbps, 96 kbps, 112 kbps, 128 kbps, 160 kbps, 192 kbps, 224 kbps, 256 kbps, and 320 kbps or a variable bit rate.

Radios that have a USB port can play .mp3 and .wma files stored on a USB storage device as well as AAC files that are stored on an iPod.

Compressed Audio or Mixed Mode Discs

The radio can play discs that contain both uncompressed CD audio and MP3/WMA files. If both formats are on the disc, the radio

plays both file formats in the order in which they were recorded to the disc.

CD-R or CD-RW Supported File and Folder Structure

The radio supports:

- Up to 50 folders.
- Up to eight folders in depth.
- Up to 15 playlists.
- Up to 512 files and folders.
- Playlists with an .m3u or .wpl extension.
- Files with an .mp3, .wma, or .cda file extension.

USB Supported File and Folder Structure

The radio supports:

- Up to 700 folders.
- Up to eight folders in depth.
- Up to 65,535 files.
- Folder and file names up to 64 bytes.

- Files with an .mp3 or .wma file extension.
- AAC files stored on an iPod.
- FAT16
- FAT32

Root Directory

The root directory of the disc is treated as a folder. If the root directory has compressed audio files, the directory displays on the radio as the CD label.

If a disc contains both uncompressed CD audio and MP3/WMA files, a folder under the root directory called CD accesses all of the CD audio tracks on the disc.

Empty Folder

Folders that do not contain files are skipped, and the player advances to the next folder that contains files.

Order of Play

Compressed audio files are accessed in the following order:

- Playlists (Px).

- Files stored in the root directory.
- Files stored in folders in the root directory.

Tracks are played in the following order:

- Play begins from the first track in the first playlist and continues sequentially through all tracks in each playlist. When the last track of the last playlist has played, play continues from the first track of the first playlist.
- Play begins from the first track in the first folder and continues sequentially through all tracks in each folder. When the last track of the last folder has played, play continues from the first track of the first folder.

When play enters a new folder, the display does not automatically show the new folder name unless the folder mode has been chosen as the default display. The new track name displays.

File System and Naming

The song name that displays is the song name contained in the ID3 tag. If the song name is not present in the ID3 tag, the radio displays the file name without the extension (such as .mp3) as the track name.

Track names longer than 32 characters or four pages are shortened. Parts of words on the last page of text and the extension of the filename do not display.

Preprogrammed Playlists

Preprogrammed playlists that were created using WinAmp[®], MusicMatch[®], or RealPlayer[®] software can be accessed; however, they cannot be edited using the radio. These playlists are treated as special folders containing compressed audio song files.

Playlists that have an .m3u or .pls file extension and are stored on a USB device may be supported by the radio with a USB port.

Playing a CD-R or CD-RW MP3



♪ (Tune): Turn to select MP3/WMA files.

⏮ SEEK: Press to go to the start of the current track, if more than 10 seconds on the track have played, otherwise goes to the previous track. Press and hold or press multiple times to continue moving backward through tracks.

⏭ SEEK: Press to go to the next track. Press and hold or press multiple times to continue moving forward through tracks.



⏮ REV (Reverse): Press and hold to reverse playback quickly. Sound is heard at a reduced volume and the elapsed time of the file displays. Release ⏮ REV to resume playing.

⏭ FWD (Fast Forward): Press and hold to advance playback quickly. Sound is heard at a reduced volume and the elapsed time of the file displays. Release ⏭ FWD to resume playing. The elapsed time of the file displays.

 (**Previous Folder**): Press the softkey below  to go to the first track in the previous folder.

 (**Next Folder**): Press the softkey below  to go to the first track in the next folder.

RDM (Random): Files on the disc can be listened to in random, rather than sequential order. To use random, press the softkey under the RDM tab until Random Current Disc displays to play songs in random order. Press the same softkey again to turn off random play.

 (**Music Navigator**): Press the softkey below  to play files in order by artist or album.

The player scans the disc to sort the files by artist and album ID3 tag information. It can take several minutes to scan the disc depending on the number of files on the disc. The radio may begin playing while it is scanning in the background.

When the scan is finished, the disc begins playing files in order by artist. The current artist playing is shown on the second line of the display. Once all songs by that artist are played, the player moves to the next artist in alphabetical order and begins playing files by that artist.

To listen to files by another artist, press the softkey below either arrow tab. The disc goes to the next or previous artist in alphabetical order. Continue pressing either softkey below the arrow tab until the artist displays.

To change from playback by artist to playback by album:

1. Press the softkey below the Sort tab.
2. Press the softkeys below the By Album tab.
3. Press the softkey below the Back tab to return to the main music navigator screen.

The album name displays on the second line between the arrows and songs from the current album begins to play. Once all songs from that album have played, the player moves to the next album in alphabetical order on the CD and begins playing MP3 files from that album.

To exit music navigator mode, press the softkey below the Back tab to return to normal MP3 playback.

Connecting a USB Storage Device or iPod®

To connect a USB storage device, connect the device to the USB port on the center stack.

The USB port can be used to control an iPod or a USB storage device.

To connect an iPod, connect one end of the USB cable that came with the iPod to the iPod's dock connector and connect the other end to the USB port located in the instrument panel storage area. If the

vehicle is on and the USB connection works, "OK to disconnect" and a GM logo may appear on the iPod, and iPod appears on the radio's display. The iPod music appears on the radio's display and begins playing.

The iPod charges while it is connected to the vehicle if the vehicle is in the ACC/ACCESSORY or ON/RUN position. When the vehicle is turned off, the iPod automatically powers off and will not charge or draw power from the vehicle's battery.

If you have an older iPod model that is not supported, it can still be used by connecting it to the auxiliary input jack using a standard 3.5 mm (1/8 in) stereo cable. See *Clock (Radio without Touchscreen)* on page 5-7 or *Clock (Radio with Touchscreen)* on page 5-8.

Using the Radio to Control a USB Storage Device or iPod

The radio can control a USB storage device or an iPod using the radio buttons and knobs and display song information on the radio's display.

🎵 (Tune): Turn to select files.

⏪ SEEK: Press to go to the start of the current track, if more than 10 seconds on the track have played, otherwise goes to the previous track. Press and hold or press multiple times to continue moving backward through tracks.

⏩ SEEK: Press to go to the next track. Press and hold or press multiple times to continue moving forward through tracks.

⏮ REV (Reverse): Press and hold to reverse playback quickly. Sound is heard at a reduced volume.

Release ⏮ REV to resume playing. The elapsed time of the file displays.

⏭ FWD (Fast Forward): Press and hold to advance playback quickly. Sound is heard at a reduced volume. Release ⏭ FWD to resume playing. The elapsed time of the file displays.

i (Information): Press to display additional information about the selected track.

Using Softkeys to Control a USB Storage Device or iPod

The five softkeys below the radio display are used to control the functions listed below.





To use the softkeys:

1. Press the first or fifth softkey below the radio display to display the functions listed below, or press the softkey below the function if it is currently displayed.
2. Press the softkey below the tab with the function on it to use that function.

|| (Pause): Press the softkey below **||** to pause the track. The tab appears raised when pause is being used. Press the softkey below **||** again to resume playback.

Back: Press the softkey below the Back tab to go back to the main display screen on an iPod, or the root directory on a USB storage device.



Folder View: Press the softkey below  to view the contents of the current folder on the USB drive. To browse and select files:

1. Press the softkey below .
2. Turn  to scroll through the list of folders.
3. Press  to select the folder. If there is more than one folder, repeat Steps 1 and 2 until the folder is reached.
4. Turn  to scroll through the files in the selected folder.

5. Press  to select the file to be played.

To skip through large lists, the five softkeys can be used to navigate in the following order:





- First softkey, first item in the list.
- Second softkey, 1% through the list each time the softkey is pressed.
- Third softkey, 5% through the list each time the softkey is pressed.
- Fourth softkey, 10% through the list each time the softkey is pressed.
- Fifth softkey, end of the list.

 (Music Navigator): Press the softkey below  to view and select a file on an iPod, using the iPod's menu system. Files are sorted by:

- Playlists
- Artists
- Albums

- Genres
- Songs
- Composers

To select files:

1. Press the softkey below .
2. Turn  to scroll through the list of menus.
3. Press  to select the menu.
4. Turn  to scroll through the folders or files in the selected menu.
5. Press  to select the file to be played.



To skip through large lists, the five softkeys can be used to navigate in the following order:



- First softkey, first item in the list.
- Second softkey, 1% through the list each time the softkey is pressed.
- Third softkey, 5% through the list each time the softkey is pressed.



- Fourth softkey, 10% through the list each time the softkey is pressed.
- Fifth softkey, end of the list.

Repeat Functionality

To use Repeat:





Press the softkey below  or  to select between Repeat All and Repeat Track.

 **(Repeat All):** Press the softkey below  to repeat all tracks. The tab appears lowered when Repeat All is being used. This is the default mode when a USB storage device or iPod is first connected.

 **(Repeat Track):** Press the softkey below  to repeat one track. The tab appears raised when Repeat Track is being used.

Shuffle Functionality

To use Shuffle:

Press the softkey below ,  S,  A, or  F to select between Shuffle Off, Shuffle All Songs/ Shuffle Songs, Shuffle Album, or Shuffle Folder.

 **(Shuffle Off):** This is the default mode when a USB storage device or iPod is first connected.

 S **(Shuffle All Songs/Shuffle Songs):** Shuffles all songs on the USB storage device or iPod.

 A **(Shuffle Album):** Shuffles all songs in the current album on an iPod.

 F **(Shuffle Folder):** Shuffles all songs in the current folder on a USB storage device.

MP3 (Radio with Touchscreen)

Playing an MP3 CD

To play an MP3 CD, follow the same instructions as “Playing an Audio CD.”

The following guidelines must be met when creating an MP3 disc, otherwise the CD might not play:

- Sampling rate: 16 kHz, 22.05 kHz, 24 kHz, 32 kHz, 44.1 kHz, and 48 kHz.
- Bit rates supported: 8, 16, 24, 32, 40, 48, 56, 64, 80, 96, 112, 128, 144, 160, 192, 224, 256, and 320 kbps.
- Maximum number of folders: eight folders with 255 files per folder.
- Maximum of 1,000 files on a disc.
- Recorded on a CD-R or CD-RW with a maximum capacity of 700 MB.

7-30 Infotainment System

- The Artist/Album/Song Titles/Genre information requires a CD to be fully scanned before the music navigator works with these menus.

MP3 Audio

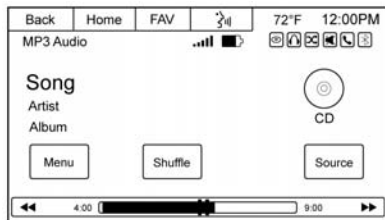

Press the Menu screen button while that source is active to access the MP3 Audio Menu.

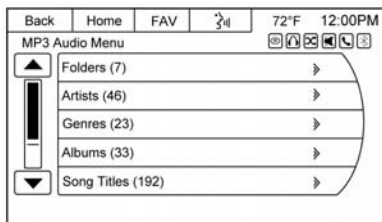

Press any of the following buttons on the MP3 Audio Menu:

Folders: Press to view the folders stored on the disc. Select a folder to view the list of all songs in that folder. There might be a delay before the list displays. Select a song from the list to begin playback.

Playlists: Press to view the playlists stored on the disc. Select a playlist to view the list of all songs in that playlist. There might be a delay before the list displays. Select a song from the list to begin playback.

Artists: Press to view the list of artists stored on the disc. Select an artist name to view a list of all songs

by the artist. There might be a delay before the list displays. Select a song from the list to begin playback.

Genres: Press to view the genres. Select a genre to view a list of all songs of that genre. Select a song from the list to begin playback.

Albums: Press to view the albums on the disc. Select the album to view a list of all songs on the album. There might be a delay before the list displays. Select a song from the list to begin playback.

Composers: Press to view the Composers stored on the disc. There might be a delay before the list displays. The Composers menu displays. Select a composer to display a list of albums from the composer.

Tracks (Song Titles): Press to display a list of all songs on the disc. Songs are displayed as stored on the disc. There might be a delay before the list displays. To begin playback, select a song from the list.

Root Directory

The root directory is treated as a folder. All files contained directly under the root directory are accessed prior to any root directory folders.

Empty Folders

If a root directory or folder is empty or contains only folders, the player advances to the next folder in the file structure that contains a compressed audio file. The empty folder(s) are not displayed or numbered.

No Folder

When the CD only contains compressed audio files without any folders or playlists, all files are under the root folder.

File System and Naming

The song titles, artists, albums, and genres are taken from the file's ID3 tag and are only displayed if present in the tag. If a song title is not

present in the ID3 tag, the radio displays the file name as the track name.

Preprogrammed Playlists

The radio recognizes preprogrammed playlists; however, there is no editing capability. These playlists are treated as special folders containing compressed audio song files.

Auxiliary Devices

The vehicle has a 3.5 mm (1/8 in) auxiliary input jack on the faceplate and a USB port in the center stack.

If equipped, there are two USB ports on the rear of the center console that can be used for charging only. They can charge devices that draw 2.1 amps or less. See the device's owner manual for the specification.

Using the 3.5 mm (1/8 in) Auxiliary Input Jack

This is not an audio output; do not plug a headphone set into the front auxiliary input jack. Connect an auxiliary input device such as an iPod, laptop computer, MP3 player, CD player, or cassette tape player to the auxiliary input jack for use as another source for audio listening.

Drivers are encouraged to set up any auxiliary device while the vehicle is in P (Park). See *Defensive Driving on page 9-3* for more information on driver distraction.

To use an auxiliary input device, connect a 3.5 mm (1/8 in) cable to the radio's front auxiliary input jack.

Press SRCE to select the device.

Using the USB Port

The USB port can control a USB storage device or an iPod using the radio buttons and knobs.

USB Supported Devices

- USB Flash Drives
- Portable USB Hard Drives
- Fifth generation or later iPod
- iPod classic® (6th generation)
- iPod nano® (3G, 4G, 5G, and 6G)
- iPod touch® (1G, 2G, 3G, and 4G)
- iPhone® (2G, 3G, 3GS, 4, and 5)
- iPad® (1G, 2G)

Not all iPods and USB drives are compatible with the USB port.

Make sure the iPod has the latest firmware from Apple® for proper operation. iPod firmware can be updated using the latest iTunes® application. See www.apple.com/itunes.

For help identifying your iPod, go to www.apple.com/support.

Rear Seat Infotainment

Rear Seat Audio (RSA) System

If equipped with RSA, rear seat passengers can listen to and control any of the music sources: radio, CDs, DVDs, or other auxiliary sources. The rear seat passengers can only control the music sources the front seat passengers are not listening to (except on some radios where dual control is allowed). For example, rear seat passengers can control a CD and listen to it through the headphones, while the driver listens to the radio through the front speakers. The rear seat passengers have control of the volume for each set of headphones.

To turn the RSA off from the front, press and hold the radio power button for more than two seconds. Press the power button on the RSA to turn it back on.

The RSA functions operate even when the main radio is off. The front audio system displays  when the RSA is on, and disappears from the display when it is off.

Audio can be heard through wired headphones (not included) plugged into the jacks on the RSA. If the vehicle has this feature, audio can also be heard on Channel 2 of the wireless headphones.

The audio system mutes the rear speakers when the RSA audio is active through the headphones.

To listen to an iPod or portable audio device through the RSA, attach the iPod or portable audio device to the front auxiliary input (if available), located on the front audio system. Turn the iPod on, then choose the front auxiliary input with the RSA SRCE button.

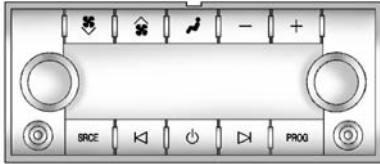

Power: Press to turn the RSA on or off.

Volume: Turn to increase or to decrease the volume of the wired headphones. The left knob controls the left headphones and the right knob controls the right headphones.

SRCE (Source): Press to select between the radio, CD, and if the vehicle has these features, DVD, front auxiliary, and rear auxiliary.

Seek: Press to go to the previous or to the next station and stay there. This function is inactive, with some radios, if the front seat passengers are listening to the radio.

Press and hold **Seek** until the display flashes to tune to an individual station. The display stops flashing after the buttons have not been pressed for more than two seconds. This function is inactive, with some radios, if the front seat passengers are listening to the radio.

While listening to a disc, press **Next** to go to the next track or chapter on the disc. Press **Seek** to go back to the start of the current track or chapter (if more than 10 seconds have played). This function is inactive, with some radios, if the front seat passengers are listening to the disc.

When a DVD video menu is being displayed, press **Seek** to perform a cursor up or down on the menu.

Hold **Seek** to perform a cursor left or right on the menu.

PROG (Program): Press to go to the next preset radio station or channel set on the main radio. This function is inactive, with some radios, if the front seat passengers are listening to the radio.

When a CD or DVD audio disc is playing, press **PROG** to go to the beginning of the CD or DVD audio. This function is inactive, with some radios, if the front seat passengers are listening to the disc.

When a disc is playing in the CD or DVD changer, press **PROG** to select the next disc if multiple discs are loaded. This function is inactive, with some radios, if the front seat passengers are listening to the disc.

When a DVD video menu is being displayed, press **PROG** to perform the **ENTER** menu function.

Phone

Bluetooth

For vehicles equipped with Bluetooth capability, the system can interact with many cell phones, allowing:

- Placement and receipt of calls in a hands-free mode.
- Sharing of the cell phone's address book or contact list with the vehicle.

To minimize driver distraction, before driving, and with the vehicle parked:

- Become familiar with the features of the cell phone. Organize the phone book and contact lists clearly and delete duplicate or rarely used entries. If possible, program speed dial or other shortcuts.
- Review the controls and operation of the infotainment system.

- Pair cell phone(s) to the vehicle. The system may not work with all cell phones. See "Pairing" in this section.
- If the cell phone has voice dialing capability, learn to use that feature to access the address book or contact list. See "Voice Pass-Thru" in this section.
- See "Storing and Deleting Phone Numbers" in this section.

Warning

When using a cell phone, it can be distracting to look too long or too often at the screen of the phone or the infotainment system. Taking your eyes off the road too long or too often could cause a crash resulting in injury or death. Focus your attention on driving.

A Bluetooth system can use a Bluetooth-capable cell phone with a Hands-Free Profile to make and

receive phone calls. The system can be used while the key is in the ON/RUN or ACC/ACCESSORY position. The range of the Bluetooth system can be up to 9.1 m (30 ft). Not all phones support all functions, and not all phones work with the in-vehicle Bluetooth system. See www.gm.com/bluetooth for more information on compatible phones.

Voice Recognition

The Bluetooth system uses voice recognition to interpret voice commands to dial phone numbers and name tags.

For additional information, say "Help" while you are in a voice recognition menu.

Noise: Keep interior noise levels to a minimum. The system may not recognize voice commands if there is too much background noise.

When to Speak: A short tone sounds after the system responds indicating when it is waiting for a voice command. Wait until the tone and then speak.



How to Speak: Speak clearly in a calm and natural voice.



Audio System

When using the in-vehicle Bluetooth system, sound comes through the vehicle's front audio system speakers and overrides the audio system. Use the audio system volume knob, during a call, to change the volume level. The adjusted volume level remains in memory for later calls. To prevent missed calls, a minimum volume level is used if the volume is turned down too low.

Bluetooth Controls

Use the buttons located on the steering wheel to operate the in-vehicle Bluetooth system. See *Steering Wheel Controls (Radio with Touchscreen)* on page 5-3 or *Steering Wheel Controls (Radio without Touchscreen)* on page 5-2.

 /  (**Press To Talk**): Press to answer incoming calls, confirm system information, and start speech recognition.

 /  (**End**): Press to end a call, reject a call, or cancel an operation.



Pairing

A Bluetooth enabled cell phone must be paired to the Bluetooth system and then connected to the vehicle before it can be used. See the cell phone manufacturer's user guide for Bluetooth functions before pairing the cell phone. If a Bluetooth phone is not connected, calls will be made using OnStar Hands-Free Calling, if equipped. See "OnStar" if equipped.

Pairing Information

- A Bluetooth phone with MP3 capability cannot be paired to the vehicle as a phone and an MP3 player at the same time.
- Up to five cell phones can be paired to the Bluetooth system.
- The pairing process is disabled when the vehicle is moving.
- Pairing only needs to be completed once, unless the pairing information on the cell phone changes or the cell phone is deleted from the system.
- Only one paired cell phone can be connected to the Bluetooth system at a time.
- If multiple paired cell phones are within range of the system, the system connects to the first available paired cell phone in the order that they were first paired to the system. To connect to a different paired phone, see "Connecting to a Different Phone" later in this section.

Pairing a Phone



1. Press  / .
2. Say “Bluetooth.” This command can be skipped.
3. Say “Pair.” The system responds with instructions and a four-digit Personal Identification Number (PIN). The PIN is used in Step 5.
4. Start the pairing process on the cell phone that you want to pair. For help with this process, see the cell phone manufacturer’s user guide.
5. Locate the device named “Your Vehicle” in the list on the cell phone. Follow the instructions on the cell phone to enter the PIN provided in Step 3. After the PIN is successfully entered, the system prompts you to provide a name for the paired cell phone. This name will be used to indicate which phones are paired and connected to the vehicle. The system responds

with “<phone name> has been successfully paired” after the pairing process is complete.

6. Repeat Steps 1–5 to pair additional phones.



Listing All Paired and Connected Phones

The system can list all cell phones paired to it. If a paired cell phone is also connected to the vehicle, the system responds with “is connected” after that phone name.

1. Press  / .
2. Say “Bluetooth.”
3. Say “List.”

Deleting a Paired Phone



If the phone name you want to delete is unknown, see “Listing All Paired and Connected Phones.”

1. Press  / .
2. Say “Bluetooth.”
3. Say “Delete.” The system asks which phone to delete.

4. Say the name of the phone you want to delete.

Connecting to a Different Phone

To connect to a different cell phone, the Bluetooth system looks for the next available cell phone in the order in which all the available cell phones were paired. Depending on which cell phone you want to connect to, you may have to use this command several times.

1. Press  / .
2. Say “Bluetooth.”
3. Say “Change phone.”
 - If another cell phone is found, the response will be “<Phone name> is now connected.”
 - If another cell phone is not found, the original phone remains connected.

Storing and Deleting Phone Numbers

The system can store up to 30 phone numbers as name tags in the Hands-Free Directory that is shared between the Bluetooth and OnStar systems, if equipped.

The following commands are used to delete and store phone numbers.



Store: This command will store a phone number, or a group of numbers as a name tag.

Digit Store: This command allows a phone number to be stored as a name tag by entering the digits one at a time.

Delete: This command is used to delete individual name tags.

Delete All Name Tags: This command deletes all stored name tags in the Hands-Free Calling Directory and the OnStar Turn-by-Turn Destinations Directory, if equipped.



Using the “Store” Command

1. Press  / .
2. Say “Store.”
3. Say the phone number or group of numbers you want to store all at once with no pauses, then follow the directions given by the system to save a name tag for this number.

Using the “Digit Store” Command



If an unwanted number is recognized by the system, say “Clear” at any time to clear the last number.

To hear all of the numbers recognized by the system, say “Verify” at any time.

1. Press  / .
2. Say “Digit Store.”
3. Say each digit, one at a time, that you want to store. After each digit is entered, the system repeats back the digit it heard

followed by a tone. After the last digit has been entered, say “Store,” and then follow the directions given by the system to save a name tag for this number.



Using the “Delete” Command

1. Press  / .
2. Say “Delete.”
3. Say the name tag you want to delete.

Using the “Delete All Name Tags” Command

This command deletes all stored name tags in the Hands-Free Calling Directory and the OnStar Turn-by-Turn Destinations Directory, if equipped.



To delete all name tags:

1. Press  / .
2. Say “Delete all name tags.”

Listing Stored Numbers

The list command will list all stored numbers and name tags.

Using the “List” Command

1. Press  / .
2. Say “Directory.”
3. Say “Hands-Free Calling.”
4. Say “List.”

Making a Call



Calls can be made using the following commands.

Dial or Call: The dial or call command can be used interchangeably to dial a phone number or a stored name tag.

Digit Dial: This command allows a phone number to be dialed by entering the digits one at a time.



Re-dial: This command is used to dial the last number used on the cell phone.

Using the “Dial” or “Call” Command

1. Press  / .
2. Say “Dial” or “Call.”
3. Say the entire number without pausing, or say the name tag.

Once connected, the person called will be heard through the audio speakers.

Calling 911 Emergency



1. Press  / .
2. Say “Dial” or “Call.”
3. Say “911.”
4. Say “Dial” or “Call.”

Using the “Digit Dial” Command

The digit dial command allows a phone number to be dialed by entering the digits one at a time. After each digit is entered, the system repeats back the digit it heard followed by a tone.



If an unwanted number is recognized by the system, say “Clear” at any time to clear the last number.

To hear all of the numbers recognized by the system, say “Verify” at any time.

1. Press  / .
2. Say “Digit Dial.”
3. Say each digit, one at a time, that you want to dial. After each digit is entered, the system repeats back the digit it heard followed by a tone. After the last digit has been entered, say “Dial.”

Once connected, the person called will be heard through the audio speakers.





Using the “Re-dial” Command

1. Press  / .
2. After the tone, say “Re-dial.”

Once connected, the person called will be heard through the audio speakers.





Receiving a Call



When an incoming call is received, the audio system mutes and a ring tone is heard in the vehicle.

- Press  /  to answer the call.
- Press  /  to ignore a call.

Call Waiting





Call waiting must be supported on the cell phone and enabled by the wireless service carrier.

- Press  /  to answer an incoming call when another call is active. The original call is placed on hold.
- Press  /  again to return to the original call.
- To ignore the incoming call, no action is required.

- Press  /  to disconnect the current call and switch to the call on hold.

Three-Way Calling

Three-way calling must be supported on the cell phone and enabled by the wireless service carrier.





1. While on a call, press  / .
2. Say “Three-way call.”
3. Use the dial or call command to dial the number of the third party to be called.
4. Once the call is connected, press  /  to link all callers together.

Ending a Call

Press  /  to end a call.

Muting a Call

During a call, all sounds from inside the vehicle can be muted so that the person on the other end of the call cannot hear them.

- To mute a call, press  /  , and then say “Mute call.”
- To cancel mute, press  /  , and then say “Un-mute call.”



Transferring a Call

Audio can be transferred between the Bluetooth system and the cell phone.



The cell phone must be paired and connected with the Bluetooth system before a call can be transferred. The connection process can take up to two minutes after the ignition is turned to ON/RUN.

Transferring Audio from the Bluetooth System to a Cell Phone

During a call with the audio in the vehicle:

1. Press  / .
2. Say "Transfer Call."



Transferring Audio to the Bluetooth System from a Cell Phone

During a call with the audio on the cell phone, press  / . The audio transfers to the vehicle. If the audio does not transfer to the vehicle, use the audio transfer feature on the cell phone. See your cell phone manufacturer's user guide for more information.

Voice Pass-Thru

Voice pass-thru allows access to the voice recognition commands on the cell phone. See your cell phone manufacturer's user guide to see if the cell phone supports this feature.

To access contacts stored in the cell phone:



1. Press  / .
2. Say "Bluetooth." This command can be skipped.
3. Say "Voice." The system responds "OK, accessing <phone name>."

The cell phone's normal prompt messages will go through their cycle according to the phone's operating instructions.

Dual Tone Multi-Frequency (DTMF) Tones

The Bluetooth system can send numbers and the numbers stored as name tags during a call. You can use this feature when calling a menu-driven phone system. Account numbers can also be stored for use.

Sending a Number or Name Tag During a Call

1. Press  / . The system responds "Ready," followed by a tone.
2. Say "Dial."
3. Say the number or name tag to send.

Clearing the System

Unless information is deleted out of the in-vehicle Bluetooth system, it will be retained indefinitely. This includes all saved name tags in the phone book and phone pairing information. For information on how to delete this information, see the previous section “Deleting a Paired Phone” and the previous sections on deleting name tags.

Other Information

The Bluetooth® word mark and logos are owned by the Bluetooth® SIG, Inc. and any use of such marks by General Motors is under license. Other trademarks and trade names are those of their respective owners.

See *Radio Frequency Statement on page 13-12*.

Settings

Press Settings on the Home Page to adjust features and preferences, such as Favorite Pages, Display, Time, and Date, etc.

1. Press the Settings screen button on the Home Page.
2. Touch-tap the scroll bar until the desired option displays. Select the desired settings to change.

A few of the setting options change the way the navigation system displays or reacts while in use.

Favorite Pages: Press to select the number of favorite pages displayed on the screen. The choice is 1–6 pages.

Display: Press to adjust the screen settings.

- **Display Off:** Select to turn the screen off. Touch the screen to turn the screen back on.

- **Rear Camera:** Select Symbols and/or Guidelines to have them display on the rear camera screen.
- **Brightness:** Select to adjust the screen brightness.

Speed Compensated Volume:

Select OFF, Low, Medium, or High sensitivity to automatically adjust the volume to minimize the effects of unwanted background noise that can result from changing road surfaces, driving speeds, or open windows. This feature works best at lower volume settings where background noise is typically louder than the sound system volume.

Audible Touch Feedback: Select to adjust the volume of the beep that is played after touching a screen button.

Notification Prompt Volume: Select to adjust the volume of the notification prompts.

7-42 Infotainment System

Set Time:

- Press the up or down arrows to change the Hours, Minutes, AM, PM, or 24 hour setting on the clock.
- Press and hold to quickly increase or decrease the time settings.
- Press OK to save the adjustments.
- Press the Back or Cancel screen button to cancel the adjustments.

Set Date:

- Press the up or down arrows to increase or decrease the Month, Day, and Year settings.
- Press and hold to quickly increase or decrease the date settings.

- Press OK to save the adjustments.
- Press the Back or Cancel screen button to cancel the adjustments.

XM Categories: Press to customize which available XM Categories are displayed and used in the system.

Create “AS IS” Infotainment

File: This is used for dealer troubleshooting.

Open Source Software: Select to view software website information.

Rear Vision Camera (If Equipped)

The rear vision camera can assist the driver when backing up by displaying a view of the area behind the vehicle.

To access the rear camera display settings, press Display from the Home screen, then press the Rear Camera screen button. The following options are available:

Symbols: Press to enable or disable the Rear Park Assist (RPA) symbols presented over the rear camera video.

Guidelines: Press to enable or disable the RPA dynamic guidelines presented over the rear camera video.

See *Rear Vision Camera (RVC)* on page 9-38.

Screen Brightness

To adjust the screen brightness, touch the screen, then press + or – on the brightness control.

Trademarks and License Agreements



Manufactured under license under U.S. Patent #'s: 5,451,942; 5,956,674; 5,974,380; 5,978,762; 6,487,535 & other U.S. and worldwide patents issued & pending. DTS and DTS Digital Surround are registered trademarks and the DTS logos and Symbol are trademarks of DTS, Inc.© 1996-2010 DTS, Inc. All Rights Reserved.



Manufactured under license from Dolby Laboratories. Dolby and the double-D symbol are trademarks of Dolby Laboratories. Copyright 1992-2010 Dolby Laboratories. All rights reserved.

Climate Controls

Climate Control Systems

Climate Control Systems	8-1
Dual Automatic Climate Control System	8-4
Rear Climate Control System	8-9
Rear Climate Control System (with Rear Seat Audio)	8-10

Air Vents

Air Vents	8-11
-----------------	------

Maintenance

Passenger Compartment Air Filter	8-12
--	------

Climate Control Systems

The heating, cooling, and ventilation in the vehicle can be controlled with this system.

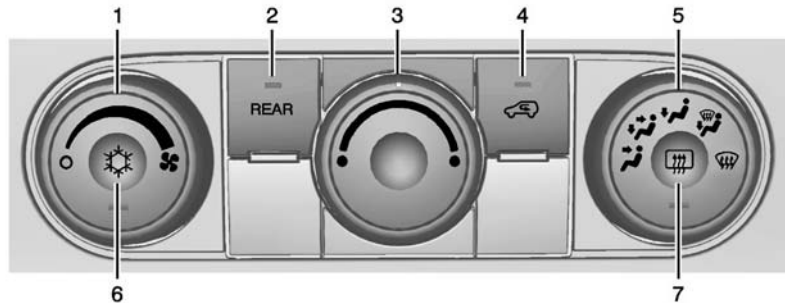

1. Fan Control
2. REAR (Rear Climate Control)
3. Temperature Control
4. Recirculation
5. Air Delivery Mode Control
6. Air Conditioning
7. Rear Window Defogger

○ **(Off):** Turn the fan control all the way counterclockwise to turn the front climate control system off.

☪ **(Fan Control):** Turn clockwise or counterclockwise to increase or decrease the fan speed.

8-2 Climate Controls

Temperature Control: Turn clockwise or counterclockwise to increase or decrease the temperature of the air flowing from the system.

Air Delivery Mode Control: Turn clockwise or counterclockwise to change the current airflow mode.

By positioning the right knob between two modes, a combination of those two modes is selected.

 **(Vent):** Air is directed to the instrument panel outlets.

 **(Bi-Level):** Air is divided between the instrument panel and floor outlets. Some air is directed toward the windshield and side window outlets. Cooler air is directed to the upper outlets and warmer air to the floor outlets.

 **(Floor):** Air is directed to the floor outlets, with some of the air directed to the windshield, side window, and second row floor outlets. In this mode, the system



automatically selects outside air. Recirculation cannot be selected while in floor mode.

 **(Defog):** This clears the windows of fog or moisture. Air is directed to the windshield, floor outlets, and side window vents. When this mode is selected, the system turns off recirculation and runs the air conditioning unless the outside temperature is less than 4°C (40°F). Recirculation cannot be selected while in the defog mode. Do not drive the vehicle until all the windows are clear.

 **(Defrost):** This clears the windshield of fog or frost more quickly. Air is directed to the windshield and side window vents, with some to the floor vents. In this mode, outside air is pulled inside the vehicle. Recirculation cannot be selected while in the defrost mode. The air conditioning system runs automatically in this setting, unless the outside temperature is less than 4°C (40°F). Do not drive the vehicle until all windows are clear.

 **(Air Conditioning):** Press to turn the air conditioning system on or off. An indicator light comes on when A/C is on. The air conditioning system does not operate when the outside temperature is below 4°C (40°F). The indicator light flashes three times and turns off when outside conditions affect air conditioning operation. This is normal.

For quicker cool down on hot days:

1. Open the windows to let hot air escape.
2. Select  mode.
3. Select .
4. Select the coolest temperature.
5. Select the highest fan speed.
6. Close the windows after the hot air has escaped.
7. Once the vehicle's interior temperature is below the outside temperature, select  mode for faster cooling.

Using recirculation for long periods of time could cause the air inside the vehicle to become too dry. To prevent this from happening, after the inside of the vehicle has cooled, turn the recirculation mode off.

The air conditioning system removes moisture from the air, so water might drip under the vehicle while idling or after turning off the engine. This is normal.

 **(Recirculation):** Press to turn the recirculation mode on or off. An indicator light comes on when recirculation is on. When the engine is turned off, the recirculation mode automatically turns off and must be re-selected when the engine is turned on again.

This mode recirculates and helps to quickly cool the air inside the vehicle. It can be used to reduce the outside air and odors that may enter the vehicle.

The recirculation mode cannot be used with floor, defrost, or defogging modes. If recirculation is selected in

these modes, the indicator flashes three times and turns off. The air conditioning also comes on when this mode is activated unless the outside air temperature is less than 4°C (40°F). While in recirculation mode the windows can fog when the weather is cold and damp. To clear the fog, select either the defog or defrost mode and increase the fan speed.

REAR (Rear Climate Control): Press to turn the rear heating and air conditioning on or off. See *Rear Climate Control System on page 8-9* or *Rear Climate Control System (with Rear Seat Audio) on page 8-10*.

Rear Window Defogger

The rear window defogger uses a warming grid to remove fog from the rear window.

 **(Rear Window Defogger):** Press to turn the rear window defogger on or off. The rear window defogger stays on for about 10 minutes, before automatically

turning off. The defogger will also turn off when the engine is turned off.

Do not drive the vehicle until all windows are clear.

For vehicles with heated outside rearview mirrors, fog or frost is cleared from the surface of the mirror when  is pressed.

Caution

Using a razor blade or sharp object on the inside rear window can damage the antenna or defogger. Repairs would not be covered by the vehicle warranty. Do not stick anything to the rear window.

8-4 Climate Controls

Dual Automatic Climate Control System

The heating, cooling, and ventilation in the vehicle can be controlled with this system.

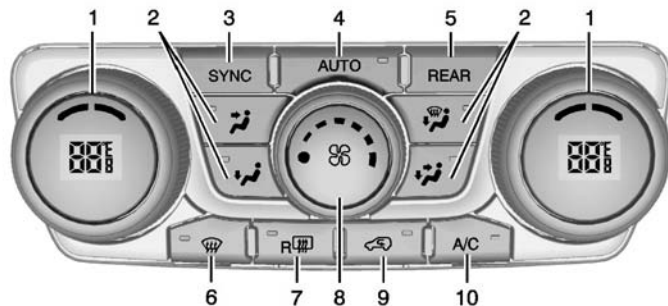

1. Driver and Passenger Side Temperature Controls
2. Air Delivery Mode Controls
3. SYNC (Synchronized Temperature)
4. AUTO (Automatic Operation)
5. REAR (Rear Climate Control)
6. Defrost
7. Rear Window Defogger
8. Fan Control
9. Recirculation
10. A/C (Air Conditioning)

Display Function

Each time the temperature, mode, or fan controls are adjusted, the climate control display shows that

function along with the inside temperature setting. The outside temperature is displayed on the instrument cluster.

○ (On/Off): Turn clockwise or counterclockwise to turn the climate control system on or off.

The climate control system will also turn on if the defrost, AUTO, or air conditioning buttons are pressed.

Automatic Operation

AUTO (Automatic): The system automatically controls the inside temperature, the air delivery, and the fan speed.

To use automatic mode:

1. Press the AUTO button.

When AUTO is selected, the current temperature(s) is displayed and the AUTO indicator light is on.

When AUTO is selected, the air conditioning and air inlet are automatically controlled. The air conditioning runs when the

outside temperature is over 4°C (40°F). The system is automatically set to outside air, unless it is hot outside and then the air inlet changes to recirculation mode to help quickly cool the vehicle. The recirculation indicator light will come on.

2. Set the temperature for the driver and passenger.

To find a comfortable setting, start with a 22°C (73°F) temperature setting and allow about 20 minutes for the system to regulate. Use the driver side or passenger side temperature control to adjust the temperature setting as necessary. The system will remain at the selected setting. Choosing the warmest or coolest temperatures does not cause the vehicle to heat or cool more quickly.

To avoid blowing cold air in cold weather, the system delays turning on the fan until warm air is available. Turn the fan knob to override this delay and select the fan speed.

Temperature Control

The driver and passenger side temperature controls are used to adjust the temperature of the air coming through the system. The temperature can be adjusted even if the system is turned off since outside air still enters the vehicle, unless the recirculation mode is selected. See “Recirculation” later in this section.

Driver Side Temperature

Control: Turn clockwise or counterclockwise to increase or decrease the driver side temperature. The driver side temperature display will show the temperature setting.

Passenger Side Temperature

Control: Turn clockwise or counterclockwise to increase or decrease the passenger side temperature. The passenger side display will show the temperature setting.

SYNC (Synchronized

Temperature): Press to set the passenger temperature to match the driver temperature setting.

Manual Operation





The air delivery mode or fan speed can be manually adjusted.

 **(Fan Control):** Turn the knob clockwise or counterclockwise to increase or decrease the fan speed.

Turning the fan control knob while in automatic control places the fan speed under manual control.

The air delivery mode remains in automatic control. The fan setting displays momentarily and then no longer displays.

8-6 Climate Controls

Air Delivery Modes: Press , , , or  to change the direction of the airflow in the vehicle. An indicator light comes on in the selected mode button. Pressing a mode button while the system is off changes the air delivery mode without turning the system on. Changing the air delivery mode while in automatic control places the system into manual control. The air delivery mode button indicator displays, and the AUTO button indicator light turns off.

 **(Vent):** Air is directed to the instrument panel outlets.

 **(Bi-Level):** Air is divided between the instrument panel and floor outlets. Some air is directed towards the windshield and side window outlets. Cooler air is directed to the upper outlets and warmer air to the floor outlets.

 **(Floor):** Air is directed to the floor outlets, with some of the air directed to the windshield, side window, and second row floor outlets. In this mode, the system uses outside air.

 **(Defog):** This mode clears the windows of fog or moisture. Air is directed to the windshield, floor outlets, and side window vents. When this mode is selected, the system turns off recirculation and runs the air conditioning compressor unless the outside temperature is less than 4°C (40°F). Do not drive the vehicle until all the windows are clear.

 **(Defrost):** Press to turn the defrost on or off. This mode quickly clears the windshield of fog or frost. Air is directed to the windshield, side window, and floor vents. In this mode, outside air is pulled inside the vehicle. The air conditioning system runs automatically in this setting, unless the outside temperature is less than 4°C (40°F).

Do not drive the vehicle until all the windows are clear.

Air Conditioning

A/C (Air Conditioning): Press to turn the air conditioning on and off. An indicator light comes on when A/C is on.

The A/C does not work when the outside temperature is below 4°C (40°F). If A/C is pressed the indicator flashes three times and turns off to show that the A/C mode is not available. If the A/C is on and the outside temperature drops below a temperature which is too cool for air conditioning to be effective, the A/C indicator turns off to show that the A/C mode has been canceled.

On hot days, open the windows briefly to let hot inside air escape. This helps reduce the time it takes for the interior of the vehicle to cool down.

The air conditioning system removes moisture from the air, so water might drip under the vehicle while idling or after turning off the engine. This is normal.

 **(Recirculation):** Press to alternate between recirculating air inside the vehicle or pulling in outside air. An indicator light comes on when recirculation mode is active. With each ignition cycle, the recirculation mode is reset to automatic. When the engine is turned on, outside air or recirculation is automatically selected for better performance.

When recirculation is activated, the air conditioning compressor comes on and helps to quickly cool the air inside the vehicle. This mode also helps to reduce the outside air and odors that may enter the vehicle.

The recirculation mode cannot be used with floor, defog, or defrosting modes. If recirculation is selected in these modes, the indicator flashes three times and turns off. While in recirculation mode the windows can fog when the weather is cold and damp. To clear the fog, select either the defog or defrost mode and increase the fan speed.

REAR: Press to turn the rear heating and air conditioning on or off. See *Rear Climate Control System on page 8-9* or *Rear Climate Control System (with Rear Seat Audio) on page 8-10*.

Rear Window Defogger

The rear window defogger uses a warming grid to remove fog from the rear window.

 **(Rear Window Defogger):** Press to turn the rear window defogger on or off. The rear window defogger stays on for about 10 minutes, before turning off. The defogger also turns off when the engine is turned off. Do not drive the vehicle until all the windows are clear.

If equipped with heated outside rearview mirrors, fog or frost is cleared from the surface of the mirror when the rear window defog button is pressed.

Caution

Using a razor blade or sharp object on the inside rear window can damage the antenna or defogger. Repairs would not be covered by the vehicle warranty. Do not stick anything to the rear window.

8-8 Climate Controls

Sensors

The solar sensor in the defrost grille in the middle of the instrument panel, monitors the solar heat. Do not cover the solar sensor or the system will not work properly.

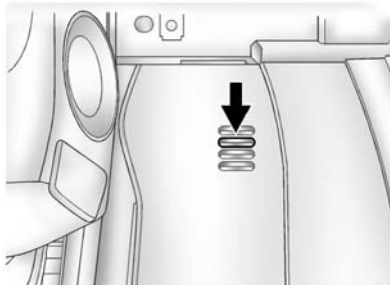

The interior temperature sensor, on the instrument panel to the right of the steering column, measures the temperature of the air inside the vehicle.

There is also an exterior temperature sensor behind the front grille. This sensor reads the outside air temperature and helps maintain the temperature inside the vehicle. Any cover on the front of the vehicle could cause a false reading in the displayed temperature.

The climate control system uses the information from these sensors to maintain comfort settings by adjusting the temperature, fan speed, and air delivery mode. The system may also supply cooler air to the side of the vehicle facing the sun. The recirculation mode will also be used as needed to maintain cool outlet temperatures.

Rear Climate Control System

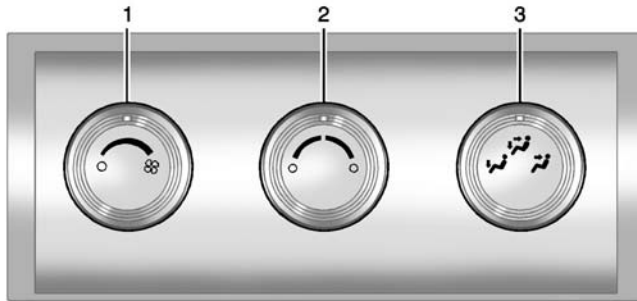

1. Fan Control
2. Temperature Control
3. Air Delivery Mode Control

For vehicles with the rear climate control system, the controls are located on the rear of the center console. The system can also be controlled with the front controls.

Press the REAR button on the front climate control system to control the rear climate control system. The REAR text displays when the rear system is on.

Sync Mode: This mode matches the rear climate control to the front climate control settings. It comes on when REAR is pressed.

Independent Mode: This mode directs rear seating airflow according to the settings of the rear controls. It comes on when any rear control is adjusted.

Fan Control: Turn clockwise or counterclockwise to increase or decrease the fan speed. Turn the knob to  to turn the fan off.

Temperature Control: Turn clockwise or counterclockwise to increase or decrease the airflow temperature.

Air Delivery Mode Control: Turn to the desired mode to change the airflow direction.

 **(Vent):** Air is directed through the overhead outlets.

 **(Bi-Level):** Air is directed through the rear floor outlets, as well as the overhead outlets.

 **(Floor):** Air is directed through the floor outlets. The rear system floor outlets are located under the third row seats.

Rear Climate Control System (with Rear Seat Audio)

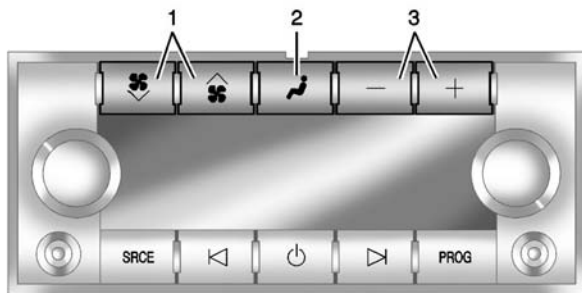

1. Fan Control
2. Air Delivery Mode Control
3. Temperature Control

If equipped with the rear climate control system, the controls are on the rear of the center console.



Press the REAR button on the front climate control system to control the rear climate control system. The system also turns on if any of the

rear controls, except , are pressed. The display is activated when the rear system is on.

The system can also be turned off by pressing  until the fan goes off.

Sync Mode: This mode matches the rear climate control to the front climate control settings. It comes on when REAR is pressed.

Independent Mode: This mode directs rear seating airflow according to the settings of the rear controls. It comes on when any rear control is adjusted.

 and  (Fan Control): Press the fan up or down buttons to increase or decrease the fan speed.

Temperature Control: Press + or - to increase or decrease the air temperature. The temperature settings will display in 0-12 increments, going from the coolest (0) to the warmest (12) setting.

 (Air Delivery Mode Control): Press to manually change the direction of the airflow. Repeatedly press the button until the desired mode appears on the display.

 (Vent): Air is directed through the overhead outlets.

 **(Bi-Level):** Air is directed through the rear floor outlets, as well as the overhead outlets.

 **(Floor):** Air is directed through the floor outlets. The rear system floor outlets are under the third row seats.

Air Vents

Use the slider switch in the center of the outlet, to change the direction of the airflow. Use the thumbwheel near the outlet to control the amount of airflow or to shut off the airflow.

Keep all outlets open whenever possible for best system performance.

Operation Tips

- Clear away any ice, snow, or leaves from the air inlets at the base of the windshield that can block the flow of air into the vehicle.
- Use of non-GM approved hood deflectors can adversely affect the performance of the system.
- Keep the path under all seats clear of objects to help circulate the air inside the vehicle more effectively.
- If fogging reoccurs while in vent or bi-level modes with mild temperature throughout the vehicle, turn on the air conditioner to reduce windshield fogging.

Maintenance

Passenger Compartment Air Filter

The filter removes dust, pollen, and other airborne irritants from outside air and inside air when in recirculation mode.

The filter should be replaced as part of routine scheduled maintenance.

See *Maintenance Schedule* on page 11-2. To find out what type of replacement filter to use, see *Maintenance Replacement Parts* on page 11-13.

1. Open the glove box.

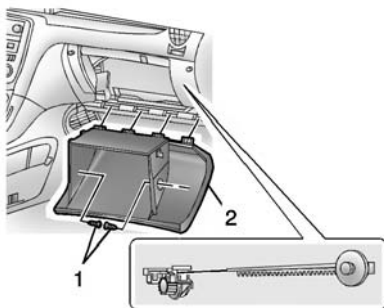

2. Twist the compartment retainers (1) and pull outward to remove.
3. Lower the instrument panel compartment assembly (2) beyond the stops.
4. If needed, unsnap the instrument panel compartment assembly (2) from the instrument panel. When reinstalling, be sure the instrument panel compartment dampener arm is aligned properly to the dampener gear assembly.

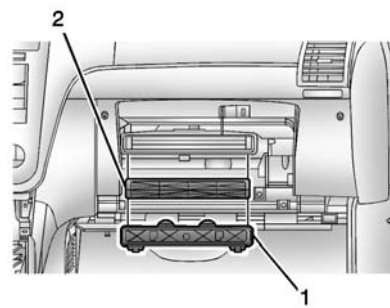

5. Squeeze the housing cover (1) tabs to remove.
6. Remove the old air filter from the passenger compartment air filter housing (2).
7. Install the new air filter.
8. Replace the housing cover.
9. If removed, reinstall the instrument panel compartment assembly.
10. Reinstall the compartment retainers.

See your dealer if additional assistance is needed.

Driving and Operating

Driving Information

Distracted Driving	9-2
Defensive Driving	9-3
Drunk Driving	9-3
Control of a Vehicle	9-3
Braking	9-3
Steering	9-4
Off-Road Recovery	9-5
Loss of Control	9-5
Driving on Wet Roads	9-6
Hill and Mountain Roads	9-6
Winter Driving	9-7
If the Vehicle Is Stuck	9-9
Vehicle Load Limits	9-9

Starting and Operating

New Vehicle Break-In	9-14
Ignition Positions	9-14
Starting the Engine	9-16

Engine Heater	9-17
Retained Accessory Power (RAP)	9-18
Shifting Into Park	9-19
Shifting out of Park	9-20
Parking over Things That Burn	9-20

Engine Exhaust

Engine Exhaust	9-21
Running the Vehicle While Parked	9-21

Automatic Transmission

Automatic Transmission	9-22
Manual Mode	9-24
Tow/Haul Mode	9-25

Drive Systems

All-Wheel Drive	9-25
-----------------------	------

Brakes

Antilock Brake System (ABS)	9-26
Parking Brake	9-27
Brake Assist	9-27
Hill Start Assist (HSA)	9-28

Ride Control Systems

Traction Control/Electronic Stability Control	9-28
--	------

Cruise Control

Cruise Control	9-30
----------------------	------

Driver Assistance Systems

Forward Collision Alert (FCA) System	9-32
Parking Assist	9-34
Side Blind Zone Alert (SBZA)	9-36
Rear Vision Camera (RVC)	9-38
Lane Departure Warning (LDW)	9-41

Fuel

Fuel	9-42
California Fuel Requirements	9-43
Fuels in Foreign Countries ...	9-44
Fuel Additives	9-44
Filling the Tank	9-44
Filling a Portable Fuel Container	9-46

9-2 Driving and Operating

Trailer Towing

General Towing Information	9-46
Driving Characteristics and Towing Tips	9-47
Trailer Towing	9-50
Towing Equipment	9-52

Conversions and Add-Ons

Add-On Electrical Equipment	9-54
-----------------------------------	------

Driving Information

Distracted Driving

Distraction comes in many forms and can take your focus from the task of driving. Exercise good judgment and do not let other activities divert your attention away from the road. Many local governments have enacted laws regarding driver distraction. Become familiar with the local laws in your area.

To avoid distracted driving, always keep your eyes on the road, hands on the wheel, and mind on the drive.

- Do not use a phone in demanding driving situations. Use a hands-free method to place or receive necessary phone calls.
- Watch the road. Do not read, take notes, or look up information on phones or other electronic devices.
- Designate a front seat passenger to handle potential distractions.
- Become familiar with vehicle features before driving, such as programming favorite radio stations and adjusting climate control and seat settings. Program all trip information into any navigation device prior to driving.
- Wait until the vehicle is parked to retrieve items that have fallen to the floor.
- Stop or park the vehicle to tend to children.
- Keep pets in an appropriate carrier or restraint.
- Avoid stressful conversations while driving, whether with a passenger or on a cell phone.

 **Warning**

Taking your eyes off the road too long or too often could cause a crash resulting in injury or death. Focus your attention on driving.

Refer to the Infotainment section and the infotainment manual for more information on using that system, including pairing and using a cell phone.

Defensive Driving

Defensive driving means “always expect the unexpected.” The first step in driving defensively is to wear the safety belt. See *Safety Belts on page 3-13*.

- Assume that other road users (pedestrians, bicyclists, and other drivers) are going to be careless and make mistakes. Anticipate what they might do and be ready.

- Allow enough following distance between you and the driver in front of you.
- Focus on the task of driving.

Drunk Driving

Death and injury associated with drinking and driving is a global tragedy.

 **Warning**

Drinking and then driving is very dangerous. Your reflexes, perceptions, attentiveness, and judgment can be affected by even a small amount of alcohol. You can have a serious — or even fatal — collision if you drive after drinking.

Do not drink and drive or ride with a driver who has been drinking. Ride home in a cab; or if you are with a group, designate a driver who will not drink.

Control of a Vehicle

Braking, steering, and accelerating are important factors in helping to control a vehicle while driving.

Braking

Braking action involves perception time and reaction time. Deciding to push the brake pedal is perception time. Actually doing it is reaction time.

Average driver reaction time is about three-quarters of a second. In that time, a vehicle moving at 100 km/h (60 mph) travels 20 m (66 ft), which could be a lot of distance in an emergency.

Helpful braking tips to keep in mind include:

- Keep enough distance between you and the vehicle in front of you.
- Avoid needless heavy braking.
- Keep pace with traffic.

9-4 Driving and Operating

If the engine ever stops while the vehicle is being driven, brake normally but do not pump the brakes. Doing so could make the pedal harder to push down. If the engine stops, there will be some power brake assist but it will be used when the brake is applied. Once the power assist is used up, it can take longer to stop and the brake pedal will be harder to push.

Steering

Variable Effort Steering

Some vehicles have a steering system that varies the amount of effort required to steer the vehicle in relation to the speed of the vehicle.

The amount of steering effort required is less at slower speeds to make the vehicle more maneuverable and easier to park. At faster speeds, the steering effort increases to provide a sport-like feel to the steering. This provides maximum control and stability.

If the vehicle seems harder to steer than normal when parking or driving slowly, there may be a problem with the system. You will still have power steering, but steering will be stiffer than normal at slow speeds. See your dealer for service.

Hydraulic Power Steering

This vehicle has hydraulic power steering. It may require maintenance. See *Power Steering Fluid* on page 10-19.

If power steering assist is lost because the engine stops, or there is a system malfunction, the vehicle can be steered but may require increased effort. See your dealer if there is a problem.

Caution

If the steering wheel is turned until it reaches the end of its travel, and is held in that position for more than 15 seconds,

(Continued)

Caution (Continued)

damage may occur to the power steering system and there may be loss of power steering assist.

Curve Tips

- Take curves at a reasonable speed.
- Reduce speed before entering a curve.
- Maintain a reasonable, steady speed through the curve.
- Wait until the vehicle is out of the curve before accelerating gently into the straightaway.

Steering in Emergencies

- There are some situations when steering around a problem may be more effective than braking.
- Holding both sides of the steering wheel allows you to turn 180 degrees without removing a hand.

- Antilock Brake System (ABS) allows steering while braking.

Off-Road Recovery

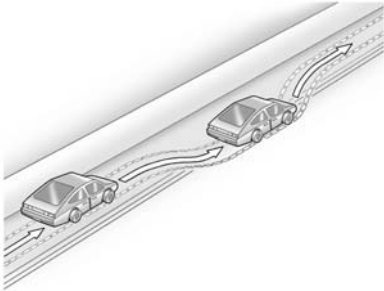

The vehicle's right wheels can drop off the edge of a road onto the shoulder while driving. Follow these tips:

1. Ease off the accelerator and then, if there is nothing in the way, steer the vehicle so that it straddles the edge of the pavement.

2. Turn the steering wheel about one-eighth of a turn, until the right front tire contacts the pavement edge.
3. Turn the steering wheel to go straight down the roadway.

Loss of Control

Skidding

There are three types of skids that correspond to the vehicle's three control systems:

- Braking Skid — wheels are not rolling.
- Steering or Cornering Skid — too much speed or steering in a curve causes tires to slip and lose cornering force.
- Acceleration Skid — too much throttle causes the driving wheels to spin.

Defensive drivers avoid most skids by taking reasonable care suited to existing conditions, and by not overdriving those conditions. But skids are always possible.

If the vehicle starts to slide, follow these suggestions:

- Ease your foot off the accelerator pedal and steer the way you want the vehicle to go. The vehicle may straighten out. Be ready for a second skid if it occurs.
- Slow down and adjust your driving according to weather conditions. Stopping distance can be longer and vehicle control can be affected when traction is reduced by water, snow, ice, gravel, or other material on the road. Learn to recognize warning clues — such as enough water, ice, or packed snow on the road to make a mirrored surface — and slow down when you have any doubt.

9-6 Driving and Operating

- Try to avoid sudden steering, acceleration, or braking, including reducing vehicle speed by shifting to a lower gear. Any sudden changes could cause the tires to slide.

Remember: Antilock brakes help avoid only the braking skid.

Driving on Wet Roads

Rain and wet roads can reduce vehicle traction and affect your ability to stop and accelerate. Always drive slower in these types of driving conditions and avoid driving through large puddles and deep-standing or flowing water.

Warning

Wet brakes can cause crashes. They might not work as well in a quick stop and could cause pulling to one side. You could lose control of the vehicle.

(Continued)

Warning (Continued)

After driving through a large puddle of water or a car/vehicle wash, lightly apply the brake pedal until the brakes work normally.

Flowing or rushing water creates strong forces. Driving through flowing water could cause the vehicle to be carried away. If this happens, you and other vehicle occupants could drown. Do not ignore police warnings and be very cautious about trying to drive through flowing water.

Hydroplaning

Hydroplaning is dangerous. Water can build up under the vehicle's tires so they actually ride on the water. This can happen if the road is wet enough and you are going fast enough. When the vehicle is hydroplaning, it has little or no contact with the road.

There is no hard and fast rule about hydroplaning. The best advice is to slow down when the road is wet.

Other Rainy Weather Tips

Besides slowing down, other wet weather driving tips include:

- Allow extra following distance.
- Pass with caution.
- Keep windshield wiping equipment in good shape.
- Keep the windshield washer fluid reservoir filled.
- Have good tires with proper tread depth. See *Tires on page 10-35*.
- Turn off cruise control.

Hill and Mountain Roads

Driving on steep hills or through mountains is different than driving on flat or rolling terrain. Tips for driving in these conditions include:

- Keep the vehicle serviced and in good shape.

- Check all fluid levels and brakes, tires, cooling system, and transmission.
- Shift to a lower gear when going down steep or long hills.

 **Warning**

Using the brakes to slow the vehicle on a long downhill slope can cause brake overheating, can reduce brake performance, and could result in a loss of braking. Shift the transmission to a lower gear to let the engine assist the brakes on a steep downhill slope.

 **Warning**

Coasting downhill in N (Neutral) or with the ignition off is dangerous. This can cause overheating of the brakes and

(Continued)

Warning (Continued)

loss of steering. Always have the engine running and the vehicle in gear.

- Stay in your own lane. Do not swing wide or cut across the center of the road. Drive at speeds that let you stay in your own lane.
- Be alert on top of hills; something could be in your lane (stalled car, accident).
- Pay attention to special road signs (falling rocks area, winding roads, long grades, passing or no-passing zones) and take appropriate action.

Winter Driving

Driving on Snow or Ice

Drive carefully when there is snow or ice between the tires and the road, creating less traction or grip.

Wet ice can occur at about 0°C (32°F) when freezing rain begins to fall, resulting in even less traction. Avoid driving on wet ice or in freezing rain until roads can be treated with salt or sand.

Drive with caution, whatever the condition. Accelerate gently so traction is not lost. Accelerating too quickly causes the wheels to spin and makes the surface under the tires slick, so there is even less traction.

Traction Control should be turned on. See *Traction Control/Electronic Stability Control on page 9-28*.

The Antilock Brake System (ABS) improves vehicle stability during hard stops on slippery roads, but apply the brakes sooner than when on dry pavement. See *Antilock Brake System (ABS) on page 9-26*.

Allow greater following distance on any slippery road and watch for slippery spots. Icy patches can occur on otherwise clear roads in shaded areas. The surface of a

9-8 Driving and Operating

curve or an overpass can remain icy when the surrounding roads are clear. Avoid sudden steering maneuvers and braking while on ice.

Turn off cruise control on slippery surfaces.

Blizzard Conditions

Being stuck in snow can be a serious situation. Stay with the vehicle unless there is help nearby. If possible, use Roadside Assistance. See *Roadside Assistance Program on page 13-5*. To get help and keep everyone in the vehicle safe:

- Turn on the hazard warning flashers.
- Tie a red cloth to an outside mirror.

Warning

Snow can trap engine exhaust under the vehicle. This may cause exhaust gases to get inside. Engine exhaust contains carbon monoxide (CO) which cannot be seen or smelled. It can cause unconsciousness and even death.

If the vehicle is stuck in the snow:

- Clear away snow from around the base of your vehicle, especially any that is blocking the exhaust pipe.
- Check again from time to time to be sure snow does not collect there.
- Open a window about 5 cm (2 in) on the side of the vehicle that is away from the wind to bring in fresh air.

(Continued)

Warning (Continued)

- Fully open the air outlets on or under the instrument panel.
- Adjust the climate control system to a setting that circulates the air inside the vehicle and set the fan speed to the highest setting. See “Climate Control Systems”.

For more information about carbon monoxide, see *Engine Exhaust on page 9-21*.

To save fuel, run the engine for only short periods as needed to warm the vehicle and then shut the engine off and close the window most of the way to save heat. Repeat this until help arrives but only when you feel really uncomfortable from the cold. Moving about to keep warm also helps.

If it takes some time for help to arrive, now and then when you run the engine, push the accelerator pedal slightly so the engine runs faster than the idle speed. This keeps the battery charged to restart the vehicle and to signal for help with the headlamps. Do this as little as possible to save fuel.

If the Vehicle Is Stuck

Slowly and cautiously spin the wheels to free the vehicle when stuck in sand, mud, ice, or snow.

If stuck too severely for the traction system to free the vehicle, turn the traction system off and use the rocking method. See *Traction Control/Electronic Stability Control* on page 9-28.

Warning

If the vehicle's tires spin at high speed, they can explode, and you or others could be injured. The

(Continued)

Warning (Continued)

vehicle can overheat, causing an engine compartment fire or other damage. Spin the wheels as little as possible and avoid going above 56 km/h (35 mph).

Rocking the Vehicle to Get it Out

Turn the steering wheel left and right to clear the area around the front wheels. Turn off any traction system. Shift back and forth between R (Reverse) and a low forward gear, spinning the wheels as little as possible. To prevent transmission wear, wait until the wheels stop spinning before shifting gears. Release the accelerator pedal while shifting, and press lightly on the accelerator pedal when the transmission is in gear.

Slowly spinning the wheels in the forward and reverse directions causes a rocking motion that could free the vehicle. If that does not get the vehicle out after a few tries, it might need to be towed out. If the vehicle does need to be towed out, see *Towing the Vehicle* on page 10-70.

Vehicle Load Limits

It is very important to know how much weight your vehicle can carry. This weight is called the vehicle capacity weight and includes the weight of all occupants, cargo, and all nonfactory-installed options. Two labels on your vehicle show how much weight it may properly carry, the Tire and Loading Information label and the Certification/Tire label.

Warning

Do not load the vehicle any heavier than the Gross Vehicle Weight Rating (GVWR), or either the maximum front or rear Gross Axle Weight Rating (GAWR). This can cause systems to break and change the way the vehicle handles. This could cause loss of control and a crash. Overloading can also shorten the life of the vehicle.

Tire and Loading Information Label

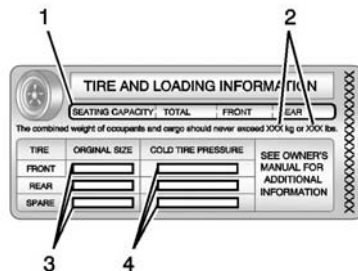

Example Label

A vehicle-specific Tire and Loading Information label is attached to the center pillar (B-pillar). The tire and loading information label shows the number of occupant seating positions (1), and the maximum vehicle capacity weight (2) in kilograms and pounds.

The Tire and Loading Information label also shows the size of the original equipment tires (3) and the recommended cold tire inflation pressures (4). For more information on tires and inflation see *Tires on page 10-35* and *Tire Pressure on page 10-43*.

There is also important loading information on the vehicle Certification/Tire label. It tells you the Gross Vehicle Weight Rating (GVWR) and the Gross Axle Weight Rating (GAWR) for the front and rear axle. See "Certification/Tire Label" later in this section.

"Steps for Determining Correct Load Limit"

1. Locate the statement "The combined weight of occupants and cargo should

- never exceed XXX kg or XXX lbs." on your vehicle's placard.
- Determine the combined weight of the driver and passengers that will be riding in your vehicle.
 - Subtract the combined weight of the driver and passengers from XXX kg or XXX lbs.
 - The resulting figure equals the available amount of cargo and luggage load capacity. For example, if the "XXX" amount equals 1400 lbs. and there will be five 150 lb passengers in your vehicle, the amount of available cargo and luggage load capacity is 650 lbs. (1400-750 (5 x 150) = 650 lbs.)

- Determine the combined weight of luggage and cargo being loaded on the vehicle. That weight may not safely exceed the available cargo and luggage load capacity calculated in Step 4.
- If your vehicle will be towing a trailer, load from your trailer will be transferred to your vehicle. Consult this manual to determine how this reduces the available cargo and luggage load capacity of your vehicle."

See *Trailer Towing on page 9-50* for important information on towing a trailer, towing safety rules and trailering tips.

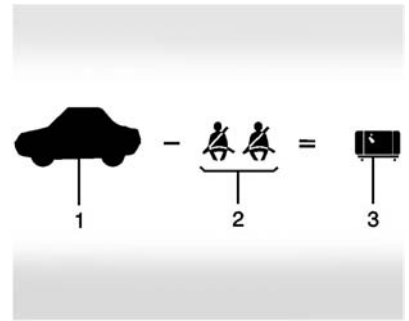

Example 1

- Vehicle Capacity Weight for Example 1 = 453 kg (1,000 lbs).
- Subtract Occupant Weight @ 68 kg (150 lbs) × 2 = 136 kg (300 lbs).
- Available Occupant and Cargo Weight = 317 kg (700 lbs).

9-12 Driving and Operating

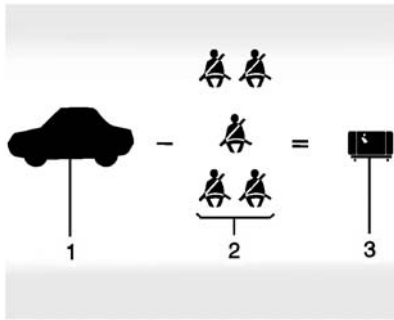

Example 2

1. Vehicle Capacity Weight for Example 2 = 453 kg (1,000 lbs).
2. Subtract Occupant Weight @ 68 kg (150 lbs) × 5 = 340 kg (750 lbs).
3. Available Cargo Weight = 113 kg (250 lbs).

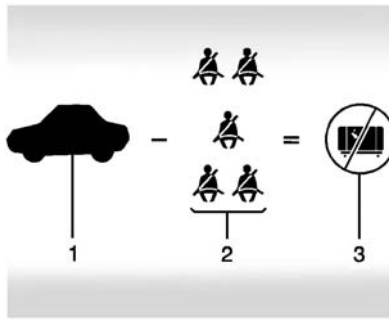

Example 3

1. Vehicle Capacity Weight for Example 3 = 453 kg (1,000 lbs).
2. Subtract Occupant Weight @ 91 kg (200 lbs) × 5 = 453 kg (1,000 lbs).
3. Available Cargo Weight = 0 kg (0 lbs).

Refer to your vehicle's tire and loading information label for specific information about your vehicle's capacity weight and

seating positions. The combined weight of the driver, passengers, and cargo should never exceed your vehicle's capacity weight.

Certification/Tire Label

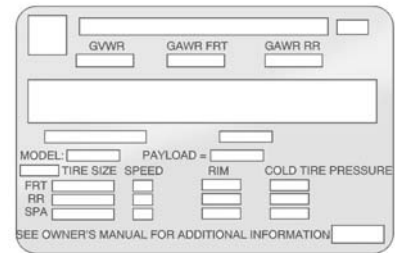

Label Example

A vehicle-specific Certification/Tire label is attached to the center pillar (B-pillar).

The label shows the gross weight capacity of your vehicle. This is called the Gross Vehicle Weight Rating (GVWR).

The GVWR includes the weight of the vehicle, all occupants, fuel, and cargo.

The Certification/Tire label also tells you the maximum weights for the front and rear axles, called the Gross Axle Weight Rating (GAWR). To find out the actual loads on your front and rear axles, you need to go to a weigh station and weigh your vehicle. Your dealer can help you with this. Be sure to spread out your load equally on both sides of the centerline.

Never exceed the GVWR for your vehicle or the GAWR for either the front or rear axle.

 **Warning**

Do not load the vehicle any heavier than the Gross Vehicle Weight Rating (GVWR), or either the maximum front or rear Gross Axle Weight Rating (GAWR). This can cause systems to break and change the way the vehicle handles. This could cause loss of control and a crash. Overloading can also shorten the life of the vehicle.

 **Caution**

Overloading the vehicle may cause damage. Repairs would not be covered by the vehicle warranty. Do not overload the vehicle.

If you put things inside your vehicle — like suitcases, tools, packages, or anything else, they will go as fast as the vehicle goes. If you have to stop or turn quickly, or if there is a crash, they will keep going.

 **Warning**

Things you put inside the vehicle can strike and injure people in a sudden stop or turn, or in a crash.

- Put things in the cargo area of the vehicle. Try to spread the weight evenly.
- Never stack heavier things, like suitcases, inside the vehicle so that some of them are above the tops of the seats.

(Continued)

Warning (Continued)

- Do not leave an unsecured child restraint in the vehicle.
- When you carry something inside the vehicle, secure it whenever you can.
- Do not leave a seat folded down unless you need to.

Starting and Operating

New Vehicle Break-In

Caution

The vehicle does not need an elaborate break-in. But it will perform better in the long run if you follow these guidelines:

- Do not drive at any one constant speed, fast or slow, for the first 805 km (500 mi). Do not make full-throttle starts. Avoid downshifting to brake or slow the vehicle.
- Avoid making hard stops for the first 322 km (200 mi) or so. During this time the new brake linings are not yet broken in. Hard stops with new linings can mean premature wear and earlier replacement. Follow this

(Continued)

Caution (Continued)

breaking-in guideline every time you get new brake linings.

Following break-in, engine speed and load can be gradually increased.

Ignition Positions

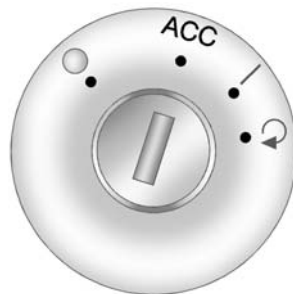

The ignition switch has four different positions.

In order to shift out of P (Park), the ignition must be in ON/RUN or ACC/ACCESSORY and the brake pedal must be applied.

 **Caution**

Using a tool to force the key to turn in the ignition could cause damage to the switch or break the key. Use the correct key, make sure it is all the way in, and turn it only with your hand. If the key cannot be turned by hand, see your dealer.

○ (STOPPING THE ENGINE/ LOCK/OFF): When the vehicle is stopped, turn the ignition switch to LOCK/OFF to turn the engine off. Retained Accessory Power (RAP) will remain active. See *Retained Accessory Power (RAP)* on page 9-18.

This position locks the ignition, transmission, and the steering wheel when the key is removed from the ignition. The key can be removed in LOCK/OFF.

The steering can bind with the wheels turned off center. If this happens, move the steering wheel from right to left while turning the key to ACC/ACCESSORY. If this does not work, then the vehicle needs service.

Do not turn the engine off when the vehicle is moving. This will cause a loss of power assist in the brake and steering systems and disable the airbags.

If the vehicle must be shut off in an emergency:

1. Brake using a firm and steady pressure. Do not pump the brakes repeatedly. This may deplete power assist, requiring increased brake pedal force.

2. Shift the vehicle to N (Neutral). This can be done while the vehicle is moving. After shifting to N (Neutral), firmly apply the brakes and steer the vehicle to a safe location.
3. Come to a complete stop, shift to P (Park), and turn the ignition to LOCK/OFF. On vehicles with an automatic transmission, the shift lever must be in P (Park) to turn the ignition switch to the LOCK/OFF position.
4. Set the parking brake. See *Parking Brake* on page 9-27.

 **Warning**

Turning off the vehicle while moving may cause loss of power assist in the brake and steering systems and disable the airbags. While driving, only shut the vehicle off in an emergency.

9-16 Driving and Operating

If the vehicle cannot be pulled over, and must be shut off while driving, turn the ignition to ACC/ACCESSORY.

ACC (ACC/ACCESSORY): This is the position in which you can operate the electrical accessories or items plugged into the accessory power outlets. This position unlocks the ignition and steering wheel. Use this position if the vehicle must be pushed or towed.

(ON/RUN): This position can be used to operate the electrical accessories and to display some instrument panel warning and indicator lights. This position can also be used for service and diagnostics, and to verify the proper operation of the malfunction indicator lamp as may be required for emission inspection purposes. The switch stays in this position when the engine is running. The transmission is also unlocked in this position. If you leave the key in the ACC/ACCESSORY or ON/RUN position with the engine off, the

battery could be drained. You may not be able to start the vehicle if the battery is allowed to drain for an extended period of time.

Ⓚ (START): This is the position that starts the engine. When the engine starts, release the key. The ignition switch will return to ON/RUN for driving.

Key Lock Release

The vehicle has an electronic key lock release system. This system is to prevent ignition key removal unless the shift lever is in P (Park).

The key lock release will not work if the battery is charged less than 9-volts, or uncharged. Try charging or jump starting the battery. See *Jump Starting on page 10-67*

Starting the Engine

Move the shift lever to P (Park) or N (Neutral). The engine will not start in any other position. To restart the engine when the vehicle is already moving, use N (Neutral) only.

Caution

Do not try to shift to P (Park) if the vehicle is moving. If you do, you could damage the transmission. Shift to P (Park) only when the vehicle is stopped.

Caution

If you add electrical parts or accessories, you could change the way the engine operates. Any resulting damage would not be covered by the vehicle warranty. See *Add-On Electrical Equipment on page 9-54*.

 **Caution**

If the steering wheel is turned until it reaches the end of its travel, and is held in that position while starting the vehicle, damage may occur to the hydraulic power steering system and there may be loss of power steering assist.

Starting Procedure

1. With your foot off the accelerator pedal, turn the ignition to START. When the engine starts, let go of the key. The idle speed will slow down as the engine warms. Do not race the engine immediately after starting it. Operate the engine and transmission gently to allow the oil to warm up and lubricate all moving parts.

 **Caution**

Cranking the engine for long periods of time, by returning the ignition to the START position immediately after cranking has ended, can overheat and damage the cranking motor, and drain the battery. Wait at least 15 seconds between each try, to let the cranking motor cool down.

2. If the engine does not start after five to 10 seconds, especially in very cold weather (below -18°C or 0°F), it could be flooded with too much gasoline. Try pushing the accelerator pedal all the way to the floor and holding it there as you hold the key in START for up to a maximum of 15 seconds. Wait at least 15 seconds between each try, to allow the cranking motor to cool

down. When the engine starts, let go of the key and accelerator. If the vehicle starts briefly but then stops again, repeat these steps. This clears the extra gasoline from the engine. Do not race the engine immediately after starting it. Operate the engine and transmission gently until the oil warms up and lubricates all moving parts.

Engine Heater

The engine coolant heater can provide easier starting and better fuel economy during engine warm-up in cold weather conditions at or below 0°F (-18°C). Vehicles with an engine coolant heater should be plugged in at least four hours before starting. Some models may have an internal thermostat in the cord which will prevent engine coolant heater operation at temperatures above 0°F (-18°C).

To Use the Engine Coolant Heater

1. Turn off the engine.
2. Open the hood and unwrap the electrical cord. The bundled cord is located on the driver side of the engine compartment, between the engine air cleaner and the windshield washer fluid reservoir. See *Engine Compartment Overview* on page 10-5.
3. Plug the cord into a normal, grounded 110-volt AC outlet.

Warning

Plugging the cord into an ungrounded outlet could cause an electrical shock. Also, the wrong kind of extension cord could overheat and cause a fire. You could be seriously injured. Plug the cord into a properly grounded three-prong 110-volt AC outlet.

(Continued)

Warning (Continued)

If the cord will not reach, use a heavy-duty three-prong extension cord rated for at least 15 amps.

4. Before starting the engine, be sure to unplug and store the cord as it was before to keep it away from moving engine parts. If you do not, it could be damaged.

The length of time the heater should remain plugged in depends on several factors. Ask a dealer in the area where you will be parking the vehicle for the best advice on this.

Retained Accessory Power (RAP)

These vehicle accessories can be used for up to 10 minutes after the ignition key is turned off:

- Audio System
- Power Windows
- Sunroof (if equipped)

Power to the windows and sunroof will work up to 10 minutes or until a door is opened.

The radio continues to work for 10 minutes or until the driver door is opened.

For an additional 10 minutes of operation, close all the doors and turn the key to ON/RUN and then back to LOCK/OFF.

All these features will work when the key is in the ON/RUN or ACC/ACCESSORY positions.

Shifting Into Park

1. Hold the brake pedal down and set the parking brake. See *Parking Brake on page 9-27* for more information.
2. Move the shift lever into P (Park) by holding in the button on the shift lever and pushing the shift lever all the way toward the front of the vehicle.
3. Turn the ignition key to LOCK/OFF.
4. Remove the key and take it with you. If you can leave the vehicle with the ignition key in your hand, the vehicle is in P (Park).

Leaving the Vehicle with the Engine Running

Warning

It can be dangerous to leave the vehicle with the engine running. It could overheat and catch fire.

(Continued)

Warning (Continued)

It is dangerous to get out of the vehicle if the shift lever is not fully in P (Park) with the parking brake firmly set. The vehicle can roll.

Do not leave the vehicle when the engine is running. If you have left the engine running, the vehicle can move suddenly. You or others could be injured. To be sure the vehicle will not move, even when you are on fairly level ground, always set the parking brake and move the shift lever to P (Park). See *Shifting Into Park on page 9-19*. If you are towing a trailer, see *Driving Characteristics and Towing Tips on page 9-47*.

If you have to leave the vehicle with the engine running, be sure the vehicle is in P (Park) and the parking brake is firmly set before you leave it. After you have moved the shift lever into P (Park), hold the

regular brake pedal down. Then, see if you can move the shift lever away from P (Park) without first pushing the button.

If you can, it means that the shift lever was not fully locked in P (Park).

Torque Lock

Torque lock is when the weight of the vehicle puts too much force on the parking pawl in the transmission. This happens when parking on a hill and shifting the transmission into P (Park) is not done properly and then it is difficult to shift out of P (Park). To prevent torque lock, set the parking brake and then shift into P (Park). To find out how, see "Shifting Into Park" listed previously.

If torque lock does occur, your vehicle may need to be pushed uphill by another vehicle to relieve the parking pawl pressure, so you can shift out of P (Park).

Shifting out of Park

The vehicle is equipped with an electronic shift lock release system. The shift lock release is designed to:

- Prevent ignition key removal unless the shift lever is in P (Park) with the shift lever button fully released, and
- Prevent movement of the shift lever out of P (Park), unless the ignition is in ON/RUN or ACC/ACCESSORY and the regular brake pedal is applied.

The shift lock release is always functional except in the case of an uncharged or low voltage (less than 9-volt) battery.

If the vehicle has an uncharged battery or a battery with low voltage, try charging or jump starting the battery. See *Jump Starting on page 10-67* for more information.

To shift out of P (Park):

1. Place the ignition in ON/RUN.
2. Apply the brake pedal.
3. Press the shift lever button.
4. Move the shift lever to the desired position.

If you still are unable to shift out of P (Park):

1. Fully release the shift lever button.
2. While holding down the brake pedal, press the shift lever button again.
3. Move the shift lever to the desired position.

If you still cannot move the shift lever from P (Park), see your dealer.

Parking over Things That Burn



Things that can burn could touch hot exhaust parts under the vehicle and ignite. Do not park over papers, leaves, dry grass, or other things that can burn.

Engine Exhaust

Warning

Engine exhaust contains carbon monoxide (CO) which cannot be seen or smelled. Exposure to CO can cause unconsciousness and even death.

Exhaust may enter the vehicle if:

- The vehicle idles in areas with poor ventilation (parking garages, tunnels, deep snow that may block underbody airflow or tail pipes).
- The exhaust smells or sounds strange or different.
- The exhaust system leaks due to corrosion or damage.
- The vehicle exhaust system has been modified, damaged, or improperly repaired.

(Continued)

Warning (Continued)

- There are holes or openings in the vehicle body from damage or aftermarket modifications that are not completely sealed.

If unusual fumes are detected or if it is suspected that exhaust is coming into the vehicle:

- Drive it only with the windows completely down.
- Have the vehicle repaired immediately.

Never park the vehicle with the engine running in an enclosed area such as a garage or a building that has no fresh air ventilation.

Running the Vehicle While Parked

It is better not to park with the engine running.

If the vehicle is left with the engine running, follow the proper steps to be sure the vehicle will not move. See *Shifting Into Park* on page 9-19 and *Engine Exhaust* on page 9-21.

If parking on a hill and pulling a trailer, see *Driving Characteristics and Towing Tips* on page 9-47.

Automatic Transmission



P (Park): This position locks the front wheels. It is the best position to use when starting the engine because the vehicle cannot move easily.

Warning

It is dangerous to get out of the vehicle if the shift lever is not fully in P (Park) with the parking brake firmly set. The vehicle can roll.

Do not leave the vehicle when the engine is running. If you have left the engine running, the vehicle can move suddenly. You or others could be injured. To be sure the vehicle will not move, even when you are on fairly level ground, always set the parking brake and move the shift lever to P (Park). See *Shifting Into Park* on page 9-19 and *Driving Characteristics and Towing Tips* on page 9-47.

Make sure the shift lever is fully in P (Park) before starting the engine. The vehicle has an automatic transmission shift lock control system. With the ignition in ON/RUN, fully apply the regular brake,

then press the button on the back of the shift lever before shifting from P (Park). If you cannot shift out of P (Park), ease pressure on the shift lever, then push the shift lever all the way into P (Park) as you maintain brake application. Then press the shift lever button and move the shift lever into another gear. See *Shifting out of Park* on page 9-20.

R (Reverse): Use this gear to back up.

Caution

Shifting to R (Reverse) while the vehicle is moving forward could damage the transmission. The repairs would not be covered by the vehicle warranty. Shift to R (Reverse) only after the vehicle is stopped.

To rock the vehicle back and forth to get out of snow, ice, or sand without damaging the transmission, see *If the Vehicle Is Stuck* on page 9-9.

N (Neutral): In this position, the engine does not connect with the wheels. To restart the engine when the vehicle is already moving, use N (Neutral) only. Also, use N (Neutral) when the vehicle is being towed.

Warning

Shifting into a drive gear while the engine is running at high speed is dangerous. Unless your foot is firmly on the brake pedal, the vehicle could move very rapidly. You could lose control and hit people or objects. Do not shift into a drive gear while the engine is running at high speed.

Caution

Shifting out of P (Park) or N (Neutral) with the engine running at high speed may damage the transmission. The repairs would not be covered by the vehicle warranty. Be sure the engine is not running at high speed when shifting the vehicle.

D (Drive): This position is for normal driving. It provides the best fuel economy. If you need more power for passing, and you are:

- Going less than 56 km/h (35 mph), push the accelerator pedal about halfway down.
- Going about 56 km/h (35 mph) or more, push the accelerator all the way down.

Caution

If the vehicle accelerates slowly, or does not shift gears, the transmission could be damaged. Have the vehicle serviced right away.

If the vehicle is stopped on a hill, with your foot off the brake pedal, the vehicle may roll. This is normal and is due to the torque converter designed to improve fuel economy and performance. Use the brake to hold the vehicle on a hill. Do not use the accelerator pedal.

L (Low): This position gives you access to gear ranges. This provides more engine braking but lower fuel economy than D (Drive). You can use it on very steep hills, or in deep snow or mud. See *Manual Mode* on page 9-24.

Manual Mode

Electronic Range Select (ERS) Mode

ERS mode allows you to choose the top-gear limit of the transmission and the vehicle's speed while driving downhill or towing a trailer. The vehicle has an electronic shift position indicator within the instrument panel cluster. When using the ERS mode a number will display next to the L, indicating the current gear that has been selected.

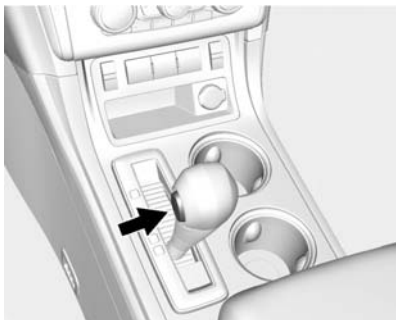

To use this feature:

1. Move the shift lever to L (Low).
2. Press the plus/minus button on the shift lever, to increase or decrease the gear range available.

When you shift from D (Drive) to L (Low), the transmission will shift to a pre-determined lower gear range. The highest gear available for this pre-determined range is displayed next to the L in the DIC. See *Driver Information Center (DIC) (With DIC Buttons)* on page 5-25 or *Driver Information Center (DIC) (Without DIC Buttons)* on page 5-31. The number displayed in the DIC is the highest gear that the transmission will be allowed to operate in. This means that all gears below that number are available. For example, when 4 (Fourth) is shown next to the L, 1 (First) through 4 (Fourth) gears are automatically shifted by the vehicle. The transmission will not

shift into 5 (Fifth) until the + (Plus) button is used or you shift back into D (Drive).

While in L (Low), the transmission will prevent shifting to a lower gear range if the engine speed is too high. You have a brief period of time to slow the vehicle. If vehicle speed is not reduced within the time allowed, the lower gear range shift will not be completed. You must further slow the vehicle, then press the - (Minus) button to the desired lower gear range.

Automatic Engine Grade Braking is not available when the ERS is active. It is available in D (Drive) for both normal and Tow/Haul mode. While using the ERS, cruise control and the Tow/Haul mode can be used. See "Tow/Haul Mode" following.

Tow/Haul Mode

 (Tow/Haul): If equipped with Tow/Haul mode, the button is on the center stack under the climate controls.

Press the button to activate the system. Press it again to deactivate the system. This feature can assist when towing or hauling a heavy load.

When Tow/Haul is activated, the Tow/Haul symbol will come on in the instrument cluster. See *Driving Characteristics and Towing Tips* on page 9-47.

Automatic Engine Grade Braking

Automatic Engine Grade Braking assists when driving on a downhill grade. It maintains vehicle speed by automatically implementing a shift schedule that uses the engine and the transmission to slow the vehicle. The system will automatically command downshifts to reduce vehicle speed, until the brake pedal is no longer being pressed.

While in the Electronic Range Select (ERS) mode, grade braking is deactivated, allowing the driver to select a range and limiting the highest gear available. Grade braking is available for normal driving and in Tow/Haul mode.

See *Automatic Transmission* on page 9-22.

Drive Systems

All-Wheel Drive

Vehicles with this feature transfer engine power, as required, to all four wheels. It is fully automatic, and adjusts itself as needed for road conditions.

When using a compact spare tire on an AWD vehicle, the system automatically detects the compact spare and reduces AWD performance to protect the system. To restore full AWD operation and prevent excessive wear on the system, replace the compact spare with a full-size tire as soon as possible. See *Compact Spare Tire* on page 10-66.

Brakes

Antilock Brake System (ABS)

This vehicle has ABS, an advanced electronic braking system that helps prevent a braking skid.

When the vehicle begins to drive away, ABS checks itself. A momentary motor or clicking noise might be heard while this test is going on, and it might even be noticed that the brake pedal moves a little. This is normal.



If there is a problem with ABS, this warning light stays on. See *Antilock Brake System (ABS) Warning Light* on page 5-21.

If driving safely on a wet road and it becomes necessary to slam on the brakes and continue braking to avoid a sudden obstacle, a computer senses the wheels are slowing down. If one of the wheels is about to stop rolling, the computer will separately work the brakes at each wheel.

ABS can change the brake pressure to each wheel, as required, faster than any driver could. This can help you steer around the obstacle while braking hard.

As the brakes are applied, the computer keeps receiving updates on wheel speed and controls braking pressure accordingly.

Remember: ABS does not change the time needed to get a foot up to the brake pedal or always decrease stopping distance. If you get too close to the vehicle in front of you, there will not be enough time to apply the brakes if that vehicle

suddenly slows or stops. Always leave enough room up ahead to stop, even with ABS.

Using ABS

Do not pump the brakes. Just hold the brake pedal down firmly and let ABS work. You may hear the ABS pump or motor operating and feel the brake pedal pulsate. This is normal.

Braking in Emergencies

ABS allows you to steer and brake at the same time. In many emergencies, steering can help more than even the very best braking.

Parking Brake

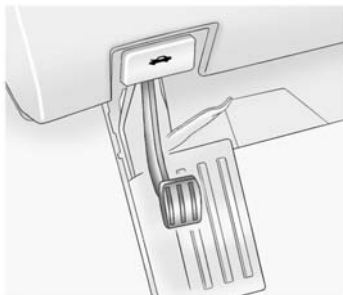

To set the parking brake, hold the regular brake pedal down, then push the parking brake pedal down.

If the ignition is on, the brake system warning light will come on. See *Brake System Warning Light* on page 5-20.

Caution

Driving with the parking brake on can overheat the brake system and cause premature wear or damage to brake system parts. Make sure that the parking brake is fully released and the brake warning light is off before driving.

To release the parking brake, hold the regular brake pedal down, then push down momentarily on the parking brake pedal until you feel the pedal release. Slowly pull your foot up off the parking brake pedal. If the parking brake is not released when you begin to drive, the brake system warning light will be on and a chime will sound warning you that the parking brake is still on.

If you are towing a trailer and are parking on a hill, see *Driving Characteristics and Towing Tips* on page 9-47.

Brake Assist

The Brake Assist feature is designed to assist the driver in stopping or decreasing vehicle speed in emergency driving conditions. This feature uses the stability system hydraulic brake control module to supplement the power brake system under conditions where the driver has quickly and forcefully applied the brake pedal in an attempt to quickly stop or slow down the vehicle. The stability system hydraulic brake control module increases brake pressure at each corner of the vehicle until the ABS activates. Minor brake pedal pulsation or pedal movement during this time is normal and the driver should continue to apply the brake pedal as the driving situation dictates. The Brake Assist feature will automatically disengage when the brake pedal is released or brake pedal pressure is quickly decreased.

Hill Start Assist (HSA)

This vehicle has an HSA feature, which may be useful when the vehicle is stopped on a grade sufficient enough to activate HSA. This feature is designed to prevent the vehicle from rolling, either forward or rearward, during vehicle drive off. After the driver completely stops and holds the vehicle in a complete standstill on a grade, HSA will be automatically activated. During the transition period between when the driver releases the brake pedal and starts to accelerate to drive off on a grade, HSA holds the braking pressure for a maximum of two seconds to ensure that there is no rolling. The brakes will automatically release when the accelerator pedal is applied within the two-second window. It will not activate if the vehicle is in a drive gear and facing downhill, or if the vehicle is facing uphill and in R (Reverse).

Ride Control Systems

Traction Control/ Electronic Stability Control

System Operation

The vehicle has a Traction Control System (TCS) and StabiliTrak[®], an electronic stability control system. These systems help limit wheel slip and assist the driver in maintaining control, especially on slippery road conditions.

TCS activates if it senses that any of the drive wheels are spinning or beginning to lose traction. When this happens, TCS applies the brakes to the spinning wheels and reduces engine power to limit wheel spin.

StabiliTrak activates when the vehicle senses a difference between the intended path and the direction the vehicle is actually traveling. StabiliTrak selectively applies braking pressure to any one of the

vehicle wheel brakes to assist the driver in keeping the vehicle on the intended path.

If cruise control is being used and traction control or StabiliTrak begins to limit wheel spin, cruise control will disengage. Cruise control may be turned back on when road conditions allow.

Both systems come on automatically when the vehicle is started and begins to move. The systems may be heard or felt while they are operating or while performing diagnostic checks. This is normal and does not mean there is a problem with the vehicle.

It is recommended to leave both systems on for normal driving conditions, but it may be necessary to turn TCS off if the vehicle gets stuck in sand, mud, ice, or snow. See *If the Vehicle Is Stuck on page 9-9* and "Turning the Systems Off and On" later in this section.



The indicator light for both systems is in the instrument cluster. This light will:

- Flash when TCS is limiting wheel spin.
- Flash when StabiliTrak is activated.
- Turn on and stay on when either system is not working.

If either system fails to turn on or to activate, a message displays in the Driver Information Center (DIC), and  comes on and stays on to indicate that the system is inactive and is not assisting the driver in maintaining control. The vehicle is safe to drive, but driving should be adjusted accordingly.

If  comes on and stays on:

1. Stop the vehicle.
2. Turn the engine off and wait 15 seconds.
3. Start the engine.

Drive the vehicle. If  comes on and stays on, the vehicle may need more time to diagnose the problem. If the condition persists, see your dealer.



Turning the Systems Off and On



The button for TCS and StabiliTrak is on the center stack.

Caution

Do not repeatedly brake or accelerate heavily when TCS is off. The vehicle driveline could be damaged.

To turn off TCS and StabiliTrak, press and release the  button. The appropriate message displays in the DIC. To turn TCS and StabiliTrak on again, press and release the  button. The appropriate message displays in the DIC. See *Ride Control System Messages on page 5-41*.

If TCS is limiting wheel spin when the  button is pressed, the system will not turn off until the wheels stop spinning.

Adding accessories can affect the vehicle performance. See *Accessories and Modifications on page 10-2*.

Cruise Control

With cruise control, a speed of about 40 km/h (25 mph) or more can be maintained without keeping your foot on the accelerator. Cruise control does not work at speeds below about 40 km/h (25 mph).

Warning

Cruise control can be dangerous where you cannot drive safely at a steady speed. Do not use the cruise control on winding roads or in heavy traffic.

Cruise control can be dangerous on slippery roads. On such roads, fast changes in tire traction can cause excessive wheel slip, and you could lose control. Do not use cruise control on slippery roads.

If the Traction Control System (TCS) or StabiliTrak system begins to limit wheel spin while cruise control is being used, the cruise control will disengage. See *Traction Control/Electronic Stability Control* on page 9-28. If a collision alert occurs when cruise control is activated, cruise control is disengaged. See *Forward Collision Alert (FCA) System* on page 9-32. When road conditions allow you to safely use it again, cruise control can be turned on.

If the brakes are applied, cruise control is disengaged.

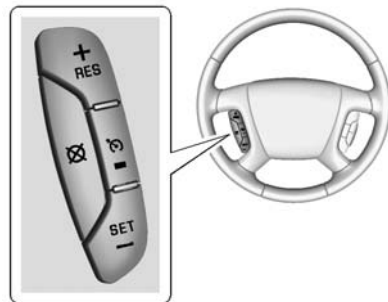



 **(On/Off):** Press to turn cruise control on or off. The indicator light on the button comes on when the cruise control is on.

+RES (Resume/Accelerate): If there is a set speed in memory, press briefly to resume to that speed or press and hold to accelerate. If cruise control is already active, use to increase vehicle speed.

SET-: Press briefly to set the speed and activate cruise control. If cruise control is already active, use to decrease vehicle speed.

 (**Cancel**): Press to disengage cruise control without erasing the set speed from memory.

Setting Cruise Control

If  is on when not in use, SET- or +RES could get pressed and go into cruise when not desired. Keep  off when cruise is not being used.

The cruise control light on the instrument cluster comes on after the cruise control has been set to the desired speed.

1. Press  to turn the cruise control system on.
2. Get up to the desired speed.
3. Press and release SET-.
4. Remove foot from the accelerator.

Resuming a Set Speed

If the cruise control is set at a desired speed and then the brakes are applied or  is pressed, the cruise control is disengaged without erasing the set speed from memory.

Once the vehicle reaches 40 km/h (25 mph) or more, press +RES. The vehicle returns to the previously set speed.

Increasing Speed While Using Cruise Control

If the cruise control system is already activated:

- Press and hold +RES until the desired speed is reached, then release it.
- To increase vehicle speed in small increments, press +RES briefly. For each press, the vehicle goes about 1.6 km/h (1 mph) faster.

The speedometer reading can be displayed in either English or metric units. See *Instrument Cluster on page 5-12*. The increment value used depends on the units displayed.

Reducing Speed While Using Cruise Control

If the cruise control system is already activated:

- Press and hold SET- until the desired lower speed is reached, then release it.
- To slow down in small increments, press SET- briefly. For each press, the vehicle goes about 1.6 km/h (1 mph) slower.

The speedometer reading can be displayed in either English or metric units. See *Instrument Cluster on page 5-12*. The increment value used depends on the units displayed.

Passing Another Vehicle While Using Cruise Control



Use the accelerator pedal to increase the vehicle speed. When you take your foot off the pedal, the vehicle will slow down to the previously set cruise speed. While pressing the accelerator pedal or shortly following the release to override cruise control, briefly pressing SET- will result in cruise control set to the current vehicle speed.

Using Cruise Control on Hills

How well the cruise control will work on hills depends upon the vehicle speed, load, and the steepness of the hills. When going up steep hills, you might have to step on the accelerator pedal to maintain your speed. When going downhill, you might have to brake or shift to a lower gear to keep your speed down. If the brake pedal is applied cruise control will disengage.

Ending Cruise Control

There are four ways to end cruise control:

- Step lightly on the brake pedal.
- Press .
- Shift the transmission to N (Neutral).
- To turn off the cruise control, press .

Erasing Speed Memory

The cruise control set speed is erased from memory if  is pressed or the ignition is turned off.

Driver Assistance Systems

Forward Collision Alert (FCA) System

If equipped, the FCA system may help to avoid or reduce the harm caused by front-end crashes. When approaching a vehicle ahead too quickly, FCA provides a red flashing alert on the windshield and rapidly beeps. FCA also lights an amber visual alert if following another vehicle much too closely.

FCA detects vehicles within a distance of approximately 60 m (197 ft) and operates at speeds above 40 km/h (25 mph).

⚠ Warning

FCA is a warning system and does not apply the brakes. When approaching a slower-moving or stopped vehicle ahead too rapidly, or when following a vehicle too closely, FCA may not provide a warning with enough time to help avoid a crash. FCA does not warn of pedestrians, animals, signs, guardrails, bridges, construction barrels, or other objects. Be ready to take action and apply the brakes. For more information, see *Defensive Driving on page 9-3*.

FCA can be disabled with the  button on the center stack.

Detecting the Vehicle Ahead

FCA warnings will not occur unless the FCA system detects a vehicle ahead. When a vehicle is detected, the vehicle ahead indicator will display green. Vehicles may not be detected on curves, highway exit ramps, or hills; or due to poor visibility. FCA will not detect another vehicle ahead until it is completely in the driving lane.

⚠ Warning

FCA does not provide a warning to help avoid a crash, unless it detects a vehicle. FCA may not detect a vehicle ahead if the FCA sensor is blocked by dirt, snow, or ice, or if the windshield is damaged. It may also not detect a vehicle on winding or hilly roads, or in conditions that can limit visibility such as fog, rain, or snow, or if the headlamps or windshield are not cleaned or in proper condition. Keep the windshield, headlamps, and FCA sensors clean and in good repair.

Collision Alert

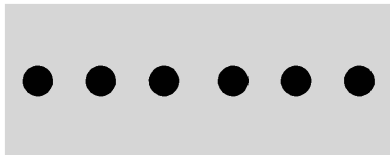

When your vehicle approaches another detected vehicle too rapidly, the red FCA display will flash on the windshield. Also, eight rapid high-pitched beeps will sound from the front. When this Collision Alert occurs, the brake system may prepare for driver braking to occur more rapidly which can cause a brief, mild deceleration. Continue to apply the brake pedal as needed.

Tailgating Alert



The vehicle ahead indicator will display amber if following a detected vehicle ahead much too closely.

Selecting the Alert Timing

The Collision Alert button is on the center stack. Press  to set the alert timing to far, medium, near, or off. The first button press shows the current control setting on the DIC. Additional button presses will change this setting. The chosen setting will remain until it is changed and will affect both the Collision Alert and the Tailgating Alert features. The timing of both alerts will vary based on vehicle speed. The faster the vehicle speed, the farther away the alert will occur. Consider traffic and weather

conditions when selecting the alert timing. The range of selectable alert timings may not be appropriate for all drivers and driving conditions.

Unnecessary Alerts

FCA may provide unnecessary alerts to turning vehicles, vehicles in other lanes, objects that are not vehicles, or shadows. These alerts are normal operation and the vehicle does not need service.

Cleaning the System

If the FCA system does not seem to operate properly, cleaning the outside of the windshield area in front of the camera sensor may correct the issue.

Parking Assist

If available, the Rear Parking Assist (RPA) system assists the driver with parking and avoiding objects while in R (Reverse). RPA operates at speeds less than 8 km/h (5 mph).

The sensors on the rear bumper are used to detect objects up to 2.5 m (8 ft) behind the vehicle, and at least 25 cm (10 in) off the ground and below liftgate level. Detection distances may be less during warmer or humid weather.

Warning

The parking assist system does not detect children, pedestrians, bicyclists, animals, or objects below the bumper or that are too close or too far from the vehicle. It is not available at speeds greater than 8 km/h (5 mph). To prevent injury, death, or vehicle damage, even with parking assist, always check the area around the vehicle and check all mirrors before backing.

How the System Works

RPA comes on automatically when the shift lever is moved into R (Reverse). A single beep sounds to indicate the system is working.

An obstacle is indicated by audible beeps. The interval between the beeps becomes shorter as the vehicle gets closer to the obstacle. When the distance is less than 30 cm (12 in) the beeping is continuous for five seconds.

Turning the System On and Off

The system can be disabled through the Driver Information Center (DIC). See “Park Assist” under *Driver Information Center (DIC) (With DIC Buttons)* on page 5-25 or *Driver Information Center (DIC) (Without DIC Buttons)* on page 5-31.

Turn off RPA when towing a trailer.

RPA defaults to the on setting each time the vehicle is started.

When the System Does Not Seem to Work Properly

The following messages may be displayed on the DIC:

SERVICE PARK ASSIST: If this message occurs, take the vehicle to your dealer to repair the system.

PARK ASST BLOCKED SEE OWNERS MANUAL: This message can occur under the following conditions:

- The sensors are not clean. Keep the vehicle's rear bumper free of mud, dirt, snow, ice, and slush. For cleaning instructions, see *Exterior Care on page 10-74*.
- The sensors are covered by frost or ice. Frost or ice can form around and behind the sensors and may not always be seen; this can occur after washing the vehicle in cold weather. The message may not clear until the frost or ice has melted.

9-36 Driving and Operating

- A trailer was attached to the vehicle, or an object was hanging out of the liftgate during the last drive cycle. Once the object is removed, RPA will return to normal operation.
- A tow bar is attached to the vehicle.
- The bumper is damaged. Take the vehicle to your dealer to repair the system.
- Other conditions, such as vibrations from a jackhammer or the compression of air brakes on a very large truck, are affecting system performance.

Side Blind Zone Alert (SBZA)

If equipped, the Side Blind Zone Alert system is a lane-changing aid that assists drivers with avoiding crashes that occur with vehicles in the side blind zone (or spot) areas.

The SBZA warning display will light up in the corresponding outside side mirror and will flash if the turn signal is on.

Warning

SBZA does not alert the driver to vehicles rapidly approaching outside of the side blind zones, pedestrians, bicyclists, or animals. It may not provide alerts when changing lanes under all driving conditions. Failure to use proper care when changing lanes may result in injury, death, or vehicle damage. Before making a lane change, always check mirrors, glance over your shoulder, and use the turn signals.

SBZA Detection Zones

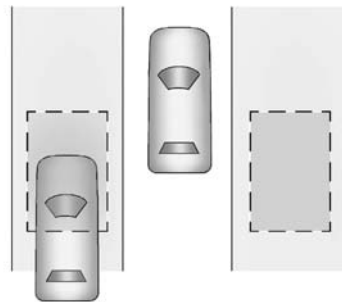

The SBZA sensor covers a zone of approximately one lane over from both sides of the vehicle, or 3.5 m (11 ft). The height of the zone is approximately between 0.5 m (1.5 ft) and 2 m (6 ft) off the ground. This zone starts at approximately the middle of the vehicle and goes back 5 m (16 ft).

How the System Works

The SBZA symbol lights up in the side mirrors when the system detects a vehicle in the next lane over that is in the side blind zone. This indicates it may be unsafe to change lanes. Before making a lane change, check the SBZA display, check mirrors, glance over your shoulder, and use the turn signals.

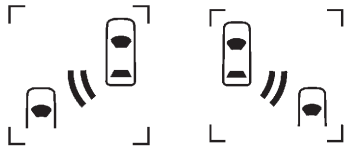

Left Side Mirror Display **Right Side Mirror Display**

When the vehicle is started, both outside mirror SBZA displays will briefly come on to indicate the system is operating. When the vehicle is moving forward, the left- or right-side mirror display will light up if a vehicle is detected in that blind zone. If the turn signal is activated in the same direction of a

detected vehicle, this display will flash as an extra warning not to change lanes.

SBZA can be disabled through the Driver Information Center (DIC). See *Driver Information Center (DIC) (With DIC Buttons)* on page 5-25 or *Driver Information Center (DIC) (Without DIC Buttons)* on page 5-31. If SBZA is disabled by the driver, the SBZA mirror displays will not light up.

When the System Does Not Seem to Work Properly

SBZA displays may not come on when passing a vehicle quickly or when towing a trailer. Keep in mind the SBZA detection zones that extend back from the side of the vehicle do not move further back when a trailer is towed. Use extra caution while changing lanes when towing a trailer. SBZA may alert you to objects attached to the vehicle, such as a trailer, bicycle, or object extending out to either side of the

vehicle. This is normal system operation; the vehicle does not need service.

SBZA may not always alert the driver to vehicles in the side blind zone, especially in wet conditions. The system does not need to be serviced. The system may light up due to guardrails, signs, trees, shrubs, and other non-moving objects. This is normal system operation; the vehicle does not need service.

SBZA may not operate when the SBZA sensors in the left or right corners of the rear bumper are covered with mud, dirt, snow, ice, or slush, or in heavy rainstorms. For cleaning instructions, see "Washing the Vehicle" under *Exterior Care* on page 10-74. If the DIC still displays the system unavailable message after cleaning both sides of the vehicle toward the rear corners of the vehicle, see your dealer.

If the SBZA displays do not light up when vehicles are in the blind zone and the system is clean, the system may need service. Take the vehicle to your dealer.

When SBZA is disabled for any reason other than the driver turning it off, the Side Blind Zone Alert ON option will not be available on the DIC menu.

FCC Information

See *Radio Frequency Statement on page 13-12*.

Rear Vision Camera (RVC)

The vehicle may have an RVC system. Read this entire section before using it.

Warning

The RVC system does not display children, pedestrians, bicyclists, crossing traffic, animals, or any other object located outside the camera's field of view, below the bumper, or under the vehicle. Perceived distances may be different from actual distances. Do not back the vehicle using only the RVC screen. Failure to use proper care before backing may result in injury, death, or vehicle damage. Always check behind and around the vehicle before backing.

Vehicles with RVC on the Rearview Mirror

The RVC system is designed to help the driver when backing up by displaying a view of the area behind the vehicle. When the key is in the ON/RUN position and the driver shifts the vehicle into R (Reverse),

the video image automatically appears on the inside rearview mirror. Once the driver shifts out of R (Reverse), the video image automatically disappears from the inside rearview mirror.

Turning the RVC System Off or On

To turn off the RVC system, press and hold  on the inside rearview mirror until the left indicator light turns off. The RVC display is now disabled.

To turn the RVC system on again, press and hold  until the left indicator light illuminates. The RVC system display is now enabled and the display will appear in the mirror normally.

Vehicles with RVC on the Infotainment System

The RVC system is designed to help the driver when backing up by displaying a view of the area behind the vehicle. When the driver shifts the vehicle into R (Reverse), the

video image automatically appears on the infotainment screen. Once the driver shifts out of R (Reverse), the screen will go back to the last screen that had been displayed, after a delay.

The RVC display remains on after shifting out of R (Reverse) for approximately 10 seconds. Return to the previous screen sooner by performing one of the following:

- Press a hard key on the infotainment system.
- Shift into P (Park).
- Reach a vehicle speed of 8 km/h (5 mph).

Symbols and Guidelines

The RVC system may have a feature that lets the driver view caution symbols on the RVC screen while using the RVC. The Rear Parking Assist (RPA) system must not be disabled to use these symbols. See *Parking Assist* on page 9-34.

The caution symbols appear when an object has been detected by the RPA system. The symbol may cover the object when viewing the RVC screen.

The RVC system may have a guideline overlay that can help the driver align the vehicle when backing into a parking spot.

To turn the symbols and guidelines on or off:

1. Shift into P (Park).
2. Press Settings on the Home screen of the infotainment system.
3. Select Rear Camera. The Rear Camera screen displays.
4. Select Symbols or Guidelines. When a checkmark appears next to the item, it is on.

Rear Cross Traffic Alert (RCTA)

On vehicles with RCTA, a red warning triangle with an arrow may also display on the RVC screen to warn of traffic coming from either

direction, behind the vehicle. When an object is detected, three beeps sound on the left or right side, depending on the direction of the detected vehicle. This system detects objects coming from up to 20 m (65 ft) from the left or right side behind the vehicle.

Use caution while backing up when towing a trailer, as the RCTA detection zones that extend out from the back of your vehicle do not move further back when a trailer is towed.

The RCTA system can be disabled through the Driver Information Center (DIC). See *Driver Information Center (DIC) (With DIC Buttons)* on page 5-25 or *Driver Information Center (DIC) (Without DIC Buttons)* on page 5-31.

Rear Vision Camera Location

The camera is located above the license plate.

9-40 Driving and Operating

The area displayed by the camera is limited and does not display objects that are close to either corner or under the bumper. The area displayed can vary depending on vehicle orientation or road conditions. Displayed images may be farther or closer than they appear.

The following illustrations show the field of view that the camera provides.

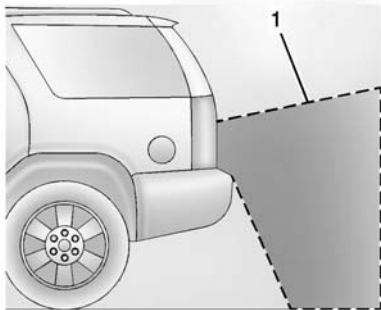

1. View displayed by the camera.

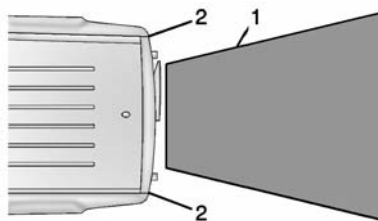

1. View displayed by the camera.
2. Corner of the rear bumper.

When the System Does Not Seem To Work Properly

The RVC system might not work properly or display a clear image if:

- The RVC is turned off. See “Turning the RVC System Off or On” earlier in this section.
- It is dark.
- The sun or the beam of headlamps is shining directly into the camera lens.

- Ice, snow, mud, or anything else builds up on the camera lens. Clean the lens, rinse it with water, and wipe it with a soft cloth.
- The back of the vehicle is in an accident. The position and mounting angle of the camera can change or the camera can be affected. Be sure to have the camera and its position and mounting angle checked at your dealer.
- There are extreme temperature changes.

The RVC system display in the rearview mirror may turn off or not appear as expected due to one of the following conditions. If this occurs the left indicator light on the mirror will flash.

- A slow flash may indicate a loss of video signal, or no video signal present during the reverse cycle.

- A fast flash may indicate that the display has been on for the maximum allowable time during a reverse cycle, or the display has reached an Over Temperature limit.

The fast flash conditions are used to protect the video device from high temperature conditions. Once conditions return to normal the device will reset and the green indicator will stop flashing.

During any of these fault conditions, the display will be blank and the indicator will continue to flash as long as the vehicle is in R (Reverse) or until the conditions return to normal.

Pressing and holding  when the left indicator light is flashing will turn off the video display along with the left indicator light.

Lane Departure Warning (LDW)

If equipped, LDW may help avoid crashes due to unintentional lane departures. It may provide an alert if the vehicle is crossing a lane without using a turn signal in that direction. LDW uses a camera sensor to detect the lane markings at speeds of 56 km/h (35 mph) or greater.

Warning

The LDW system does not steer the vehicle. The LDW system may not:

- Provide enough time to avoid a crash.
- Detect lane markings under poor weather or visibility conditions. This can occur if the windshield or headlamps are blocked by dirt, snow, or ice; if they are not in

(Continued)

Warning (Continued)

proper condition; or if the sun shines directly into the camera.

- Detect road edges.
- Detect lanes on winding or hilly roads.



If LDW only detects lane markings on one side of the road, it will only warn you when departing the lane on the side where it has detected a lane marking. Always keep your attention on the road and maintain proper vehicle position within the lane, or vehicle damage, injury, or death could occur. Always keep the windshield, headlamps, and camera sensors clean and in good repair. Do not use LDW in bad weather conditions.

How the System Works

The LDW camera sensor is on the windshield ahead of the rearview mirror.

To turn LDW on and off, press  on the center stack, forward of the shift lever. The control indicator will light when LDW is on.



When LDW is on,  is green if LDW is available to warn of a lane departure. If the vehicle crosses a detected lane marking without using the turn signal in that direction,  changes to amber and flashes. Additionally, there will be three beeps on the right or left, depending on the lane departure direction.

When the System Does Not Seem to Work Properly

The system may not detect lanes as well when there are:

- Close vehicles ahead.
- Sudden lighting changes, such as when driving through tunnels.
- Banked roads.

If the LDW system is not functioning properly when lane markings are clearly visible, cleaning the windshield may help.

LDW alerts may occur due to tar marks, shadows, cracks in the road, temporary or construction lane markings, or other road imperfections. This is normal system operation; the vehicle does not need service. Turn LDW off if these conditions continue.

Fuel

Use of the recommended fuel is an important part of the proper maintenance of this vehicle. When driving in the U.S. and Canada, to help keep the engine clean and maintain optimum vehicle performance, we recommend using TOP TIER Detergent Gasolines. See www.toptiergas.com for a list of TOP TIER Detergent Gasolines.



Use regular unleaded gasoline meeting ASTM specification D4814 with a posted octane rating of 87 or

higher. Do not use gasoline with an octane rating below 87, as it may cause engine damage and will lower fuel economy.

Use of Seasonal Fuels

Use summer and winter fuels in the appropriate season. The fuels industry automatically modifies the fuel for the appropriate season. If fuel is left in the vehicle tank for long periods of time, driving or starting could be affected. Drive the vehicle until the fuel is at one-half tank or less, then refuel with the current seasonal fuel.

Prohibited Fuels

Gasolines containing oxygenates such as ethers and ethanol, as well as reformulated gasolines, are available in some cities. If these gasolines comply with the previously described specification, then they are acceptable to use. However, E85 (85% ethanol) and other fuels containing more than 15% ethanol must be used only in FlexFuel vehicles.

Caution

Do not use fuel containing methanol. It can corrode metal parts in the fuel system and also damage plastic and rubber parts. That damage would not be covered under the vehicle warranty.

Some gasolines, mainly high octane racing gasolines, can contain an octane-enhancing additive called methylcyclopentadienyl manganese tricarbonyl (MMT). Do not use gasolines and/or fuel additives with MMT as they can reduce spark plug life and affect emission control system performance. The malfunction indicator lamp may turn on. If this occurs, see your dealer for service.

California Fuel Requirements

If the vehicle is certified to meet California Emissions Standards, it is designed to operate on fuels that meet California specifications. See the underhood emission control label. If this fuel is not available in states adopting California Emissions Standards, the vehicle will operate satisfactorily on fuels meeting federal specifications, but emission control system performance might be affected. The malfunction indicator lamp could turn on and the vehicle may not pass a smog-check test. See *Malfunction Indicator Lamp on page 5-18*. If this occurs, return to your authorized dealer for diagnosis. If it is determined that the condition is caused by the type of fuel used, repairs may not be covered by the vehicle warranty.

Fuels in Foreign Countries

If planning to drive in countries outside the U.S. or Canada, the proper fuel might be hard to find. Check regional auto club or fuel retail brand websites for availability in the country where driving. Never use leaded gasoline, fuel containing methanol, manganese, or any other fuel not recommended. Costly repairs caused by use of improper fuel would not be covered by the vehicle warranty.

Fuel Additives

To keep fuel systems clean, TOP TIER Detergent Gasoline is recommended. See *Fuel* on page 9-42.

If TOP TIER Detergent Gasoline is not available, one bottle of Fuel System Treatment PLUS added to the fuel tank at every engine oil change, can help. Fuel System Treatment PLUS is the only

gasoline additive recommended by General Motors. It is available at your dealer.

Filling the Tank

Warning

Fuel vapors and fuel fires burn violently and can cause injury or death.

- To help avoid injuries to you and others, read and follow all the instructions on the fuel pump island.
- Turn off the engine when refueling.
- Keep sparks, flames, and smoking materials away from fuel.
- Do not leave the fuel pump unattended.
- Do not reenter the vehicle while pumping fuel.

(Continued)

Warning (Continued)

- Keep children away from the fuel pump and never let children pump fuel.
- Fuel can spray out if the fuel cap is opened too quickly. This spray can happen if the tank is nearly full, and is more likely in hot weather. Open the fuel cap slowly and wait for any hiss noise to stop then unscrew the cap all the way.

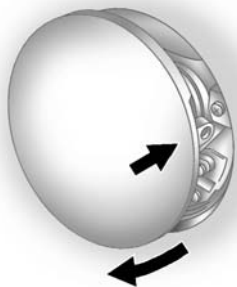

The fuel cap is behind a hinged fuel door on the driver side of the vehicle. To open the fuel door, push and release the rearward center edge of the door.

To remove the fuel cap, turn it slowly counterclockwise. The fuel cap has a spring in it; if the cap is released too soon, it will spring back to the right.

While refueling, hang the tethered fuel cap from the hook on the fuel door.

Be careful not to spill fuel. Do not top off or overfill the tank and wait a few seconds after you have finished pumping before removing the nozzle. Clean fuel from painted surfaces as soon as possible. See *Exterior Care on page 10-74*.

When replacing the fuel cap, turn it clockwise until it clicks. Make sure the cap is fully installed. The diagnostic system can determine if the fuel cap has been left off or improperly installed. This would allow fuel to evaporate into the atmosphere. See *Malfunction Indicator Lamp on page 5-18*.

Warning

If a fire starts while you are refueling, do not remove the nozzle. Shut off the flow of fuel by shutting off the pump or by notifying the station attendant. Leave the area immediately.

Caution

If a new fuel cap is needed, be sure to get the right type of cap from your dealer. The wrong type of fuel cap may not fit properly, may cause the malfunction indicator lamp to light, and could damage the fuel tank and emissions system. See *Malfunction Indicator Lamp on page 5-18*.

Filling a Portable Fuel Container

Warning

Filling a portable fuel container while it is in the vehicle can cause fuel vapors that can ignite either by static electricity or other means. You or others could be badly burned and the vehicle could be damaged. Always:

- Use approved fuel containers.
- Remove the container from the vehicle, trunk, or pickup bed before filling.
- Place the container on the ground.
- Place the nozzle inside the fill opening of the container before dispensing fuel, and

(Continued)

Warning (Continued)

keep it in contact with the fill opening until filling is complete.

- Fill the container no more than 95% full to allow for expansion.
- Do not smoke, light matches, or use lighters while pumping fuel.
- Avoid using cell phones or other electronic devices.

Trailer Towing

General Towing Information

Only use towing equipment that has been designed for the vehicle. Contact your dealer or trailering dealer for assistance with preparing the vehicle for towing a trailer. Read the entire section before towing a trailer.

For towing a disabled vehicle, see *Towing the Vehicle on page 10-70*. For towing the vehicle behind another vehicle such as a motor home, see *Recreational Vehicle Towing on page 10-71*.

Driving Characteristics and Towing Tips

Driving with a Trailer

When towing a trailer:

- Become familiar with the state and local laws that apply specifically to trailer towing.
- Do not tow a trailer during the first 800 km (500 mi), to prevent damage to the engine, axle or other parts.
- Then, during the first 800 km (500 mi) trailer towing, do not drive over 80 km/h (50 mph) and do not make starts at full throttle.
- The vehicle can tow in D (Drive) but M (Manual Mode) is recommended. See *Manual Mode on page 9-24*. Use a lower gear if the transmission shifts too often.
- Turn off Park Assist when towing.

Warning

When towing a trailer, exhaust gases may collect at the rear of the vehicle and enter if the liftgate, trunk/hatch, or rear-most window is open.

When towing a trailer:

- Do not drive with the liftgate, trunk/hatch, or rear-most window open.
- Fully open the air outlets on or under the instrument panel.
- Also adjust the Climate Control system to a setting that brings in only outside air. See "Climate Control Systems" in the Index.

For more information about Carbon Monoxide, see *Engine Exhaust on page 9-21*.

Towing a trailer requires a certain amount of experience. The combination you are driving is longer and not as responsive as the vehicle itself. Get acquainted with the handling and braking of the rig before setting out for the open road.

Before starting, check all trailer hitch parts and attachments, safety chains, electrical connectors, lamps, tires and mirrors. If the trailer has electric brakes, start the combination moving and then apply the trailer brake controller by hand to be sure the brakes work.

During the trip, check occasionally to be sure that the load is secure and the lamps and any trailer brakes still work.

Towing with a Stability Control System

When towing, the sound of the stability control system might be heard. The system is reacting to the vehicle movement caused by the

trailer, which mainly occurs during cornering. This is normal when towing heavier trailers.

Following Distance

Stay at least twice as far behind the vehicle ahead as you would when driving the vehicle without a trailer. This can help to avoid situations that require heavy braking and sudden turns.

Passing

More passing distance is needed when towing a trailer. Because the rig is longer, it is necessary to go farther beyond the passed vehicle before returning to the lane.

Backing Up

Hold the bottom of the steering wheel with one hand. To move the trailer to the left, move your hand to the left. To move the trailer to the right, move your hand to the right. Always back up slowly and, if possible, have someone guide you.

Making Turns



Making very sharp turns while trailering could cause the trailer to come in contact with the vehicle. The vehicle could be damaged. Avoid making very sharp turns while trailering.

When turning with a trailer, make wider turns than normal so the trailer will not strike soft shoulders, curbs, road signs, trees or other objects. Use the turn signal well in advance and avoid jerky or sudden maneuvers.

Turn Signals When Towing a Trailer

The turn signal indicators on the instrument cluster flash whenever signaling a turn or lane change. Properly hooked up, the trailer

lamps also flash, telling other drivers the vehicle is turning, changing lanes or stopping.

When towing a trailer, the arrows on the instrument cluster flash for turns even if the bulbs on the trailer are burned out. Check occasionally to be sure the trailer bulbs are still working.

Driving on Grades

Reduce speed and shift to a lower gear before starting down a long or steep downgrade. If the transmission is not shifted down, the brakes might have to be used so much that they would get hot and no longer work well.

The vehicle can tow in D (Drive). Use a lower gear if the transmission shifts too often.

The Tow/Haul Mode may be used if the transmission shifts too often. See *Tow/Haul Mode on page 9-25*.

When towing at high altitude on steep uphill grades, engine coolant boils at a lower temperature than at normal altitudes. If the engine is turned off immediately after towing at high altitude on steep uphill grades, the vehicle could show signs similar to engine overheating. To avoid this, let the engine run while parked, preferably on level ground, with the transmission in P (Park) for a few minutes before turning the engine off. If the overheat warning comes on, see *Engine Overheating on page 10-16*.

Parking on Hills



Parking the vehicle on a hill with the trailer attached can be dangerous. If something goes wrong, the rig could start to move. People can be injured, and both the vehicle and the trailer can be damaged. When possible, always park the rig on a flat surface.

If parking the rig on a hill:

1. Press the brake pedal, but do not shift into P (Park) yet. Turn the wheels into the curb if facing downhill or into traffic if facing uphill.
2. Have someone place chocks under the trailer wheels.

3. When the wheel chocks are in place, release the brake pedal until the chocks absorb the load.
4. Reapply the brake pedal. Then apply the parking brake and shift into P (Park).
5. Release the brake pedal.

Leaving After Parking on a Hill

1. Apply and hold the brake pedal while you:
 - Start the engine.
 - Shift into a gear.
 - Release the parking brake.
2. Let up on the brake pedal.
3. Drive slowly until the trailer is clear of the chocks.
4. Stop and have someone pick up and store the chocks.

Maintenance When Trailer Towing

The vehicle needs service more often when pulling a trailer. See the *Maintenance Schedule on page 11-2*. Things that are especially important in trailer operation are automatic transmission fluid, engine oil, axle lubricant, belts, cooling system and brake system. Inspect these before and during the trip.

Check periodically to see that all hitch nuts and bolts are tight.

Engine Cooling When Trailer Towing

The cooling system may temporarily overheat during severe operating conditions. See *Engine Overheating on page 10-16*.

Trailer Towing

Three important considerations have to do with weight:

- The weight of the trailer.
- The weight of the trailer tongue.
- The total weight on the vehicle's tires.

Weight of the Trailer

How heavy can a trailer safely be?

Speed, altitude, road grades, outside temperature, special equipment, and the amount of tongue weight the vehicle can carry must be considered. See "Weight of the Trailer Tongue" later in this section for more information.

Maximum trailer weight is calculated assuming only the driver is in the tow vehicle and it has all the required trailering equipment. The weight of additional optional equipment, passengers and cargo in the tow vehicle must be subtracted from the maximum trailer weight.

Use the following chart to determine how much the vehicle can weigh, based upon the vehicle model and options.

Vehicle	Maximum Trailer Weight	*GCWR
Front-Wheel Drive	907 kg (2,000 lb)	3 402 kg (7,500 lb)
Front-Wheel Drive, V92 Trailer Towing Package	2 359 kg (5,200 lb)	4 649 kg (10,250 lb)
All-Wheel Drive	907 kg (2,000 lb)	3 493 kg (7,700 lb)
All-Wheel Drive, V92 Trailer Towing Package	2 359 kg (5,200 lb)	4 740 kg (10,450 lb)

*The Gross Combination Weight Rating (GCWR) is the total allowable weight of the completely loaded vehicle and trailer including any passengers, cargo, equipment and conversions. The GCWR for the vehicle should not be exceeded.

Ask your dealer for trailering information or advice.

Weight of the Trailer Tongue

The tongue load (1) of any trailer is an important weight to measure because it affects the total gross weight of the vehicle. The Gross Vehicle Weight (GVW) includes the curb weight of the vehicle, any cargo carried in it, and the people who will be riding in the vehicle.

If there are a lot of options, equipment, passengers or cargo in the vehicle, it will reduce the tongue weight the vehicle can carry, which will also reduce the trailer weight the vehicle can tow. If towing a trailer, the tongue load must be added to the GVW because the vehicle will be carrying that weight, too. See *Vehicle Load Limits* on page 9-9.

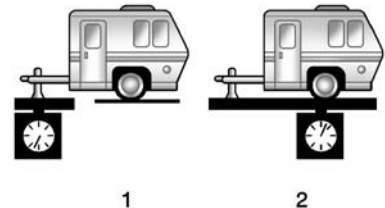

If a weight-carrying hitch or a weight-distributing hitch is being used, the trailer tongue (1) should weigh 10-15 percent of the total loaded trailer weight (2).

After loading the trailer, weigh the trailer and then the tongue, separately, to see if the weights are proper. If they are not, adjustments might be made by moving some items around in the trailer.

Trailerage may be limited by the vehicle's ability to carry tongue weight. Tongue weight cannot cause the vehicle to exceed the GVWR (Gross Vehicle Weight Rating) or the RGAWR (Rear Gross Axle Weight Rating). The effect of additional weight may reduce the trailerage capacity more than the total of the additional weight.

It is important that the vehicle does not exceed any of its ratings — GCWR, GVWR, RGAWR, Maximum Trailer Rating or Tongue Weight. The only way to be sure it is not exceeding any of these ratings is to weigh the vehicle and trailer.

Total Weight on the Vehicle's Tires

Inflate the vehicle's tires to the upper limit for cold tires. These numbers can be found on the Certification label or see *Vehicle Load Limits on page 9-9* for more information. Do not go over the GVW limit for the vehicle, or the GAWR, including the weight of the trailer tongue. If using a weight distributing hitch, do not go over the rear axle limit before applying the weight distribution spring bars.

Towing Equipment

Hitches

It is important to have the correct hitch equipment. Crosswinds, large trucks going by, and rough roads are a few reasons why the right hitch is needed.

- The rear bumper on the vehicle is not intended for hitches. Do not attach rental hitches or other bumper-type hitches to it. Use only a frame-mounted hitch that does not attach to the bumper.
- Will any holes be made in the body of the vehicle when the trailer hitch is installed? If so, then be sure to seal the holes when the hitch is removed. If the holes are not sealed, dirt, water, and deadly carbon monoxide (CO) from the exhaust may get into the vehicle. See *Engine Exhaust on page 9-21*.

Weight-Distributing Hitches and Weight Carrying Hitches

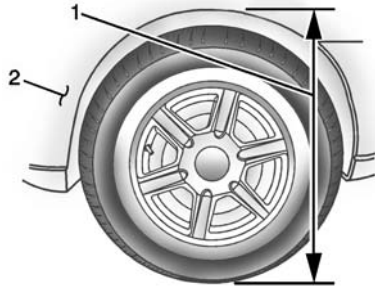

1. Body-to-Ground Distance
2. Front of Vehicle

When using a weight-distributing hitch, the hitch must be adjusted so that the distance (1) remains the same both before and after coupling the trailer to the tow vehicle.

Safety Chains

Always attach chains between the vehicle and the trailer. Cross the safety chains under the tongue of the trailer to help prevent the tongue from contacting the road if it becomes separated from the hitch. Always leave just enough slack so the rig can turn. Never allow safety chains to drag on the ground.

Trailer Brakes

A loaded trailer that weighs more than 450 kg (1,000 lbs) needs to have its own brake system that is adequate for the weight of the trailer. Be sure to read and follow the instructions for the trailer brakes so they are installed, adjusted, and maintained properly.

Because the vehicle has antilock brakes, do not try to tap into the vehicle's hydraulic brake system. If you do, both brake systems will not work well, or at all.

Trailer Wiring Harness

Basic Trailer Wiring

The trailer wiring harness, with a seven-pin connector, is located at the rear of the vehicle and is tied to the vehicle's frame. The harness connector can be plugged into a seven-pin universal heavy-duty trailer connector available through your dealer.

The seven-wire harness contains the following trailer circuits:

- Yellow: Left Stop/Turn Signal
- Dark Green: Right Stop/Turn Signal
- Brown: Taillamps
- Black: Ground
- Light Green: Back-up Lamps
- Red/Black: Battery Feed
- Dark Blue: Trailer Brake*

*The fuse for this circuit is installed in the underhood electrical center, but the wires are not connected. They should be connected by your dealer or a qualified service center.

If the back-up lamp circuit is not functional, contact your dealer.

If a remote (non-vehicle) battery is being charged, press the Tow/Haul mode switch located on the center console near the climate controls. This will boost the vehicle system voltage and properly charge the battery. If the trailer is too light for Tow/Haul mode, turn on the headlamps (non-HID only) as a second way to boost the vehicle system and charge the battery.

Electric Trailer Brake Control Wiring Provisions

These wiring provisions for an electric trailer brake controller are included with the vehicle as part of the trailer wiring package. The instrument panel contains blunt cut wires above the parking brake assembly for the electric trailer brake controller. The harness contains the following wires:

- Red/Black: Power Supply
- White: Brake Switch Signal
- Gray: Illumination
- Dark Blue: Trailer Brake Signal
- Black: Ground

The electric trailer brake controller should be installed by your dealer or a qualified service center.

Conversions and Add-Ons

Add-On Electrical Equipment



Caution

Some electrical equipment can damage the vehicle or cause components to not work and would not be covered by the warranty. Always check with your dealer before adding electrical equipment.

Add-on equipment can drain the vehicle's 12-volt battery, even if the vehicle is not operating.

The vehicle has an airbag system. Before attempting to add anything electrical to the vehicle, see *Servicing the Airbag-Equipped Vehicle* on page 3-34 and *Adding Equipment to the Airbag-Equipped Vehicle* on page 3-35.

Vehicle Care

General Information

General Information	10-2
California Proposition 65 Warning	10-2
California Perchlorate Materials Requirements	10-2
Accessories and Modifications	10-2

Vehicle Checks

Doing Your Own Service Work	10-3
Hood	10-4
Engine Compartment Overview	10-5
Engine Cover	10-6
Engine Oil	10-7
Engine Oil Life System	10-9
Automatic Transmission Fluid	10-10
Engine Air Cleaner/Filter	10-11
Cooling System	10-12
Engine Coolant	10-12
Engine Overheating	10-16

Overheated Engine Protection Operating Mode	10-18
Power Steering Fluid	10-19
Washer Fluid	10-19
Brakes	10-20
Brake Fluid	10-21
Battery	10-23
All-Wheel Drive	10-23
Starter Switch Check	10-23
Automatic Transmission Shift Lock Control Function Check	10-24
Ignition Transmission Lock Check	10-24
Park Brake and P (Park) Mechanism Check	10-24
Wiper Blade Replacement	10-25

Headlamp Aiming

Headlamp Aiming	10-26
-----------------------	-------

Bulb Replacement

Bulb Replacement	10-26
Taillamps, Turn Signal, and Stoptlamps	10-26
License Plate Lamp	10-27
Replacement Bulbs	10-28

Electrical System

High Voltage Devices and Wiring	10-28
Electrical System Overload	10-29
Fuses and Circuit Breakers	10-29
Engine Compartment Fuse Block	10-29
Instrument Panel Fuse Block	10-33

Wheels and Tires

Tires	10-35
All-Season Tires	10-36
Winter Tires	10-37
Summer Tires	10-37
Tire Sidewall Labeling	10-37
Tire Designations	10-39
Tire Terminology and Definitions	10-40
Tire Pressure	10-43
Tire Pressure Monitor System	10-44
Tire Pressure Monitor Operation	10-45
Tire Inspection	10-48
Tire Rotation	10-49

10-2 Vehicle Care

When It Is Time for New Tires	10-50
Buying New Tires	10-51
Different Size Tires and Wheels	10-52
Uniform Tire Quality Grading	10-53
Wheel Alignment and Tire Balance	10-54
Wheel Replacement	10-55
Tire Chains	10-55
If a Tire Goes Flat	10-56
Tire Changing	10-57
Compact Spare Tire	10-66
Jump Starting	
Jump Starting	10-67
Towing the Vehicle	
Towing the Vehicle	10-70
Recreational Vehicle Towing	10-71
Appearance Care	
Exterior Care	10-74
Interior Care	10-78
Floor Mats	10-82

General Information

For service and parts needs, visit your dealer. You will receive genuine GM parts and GM-trained and supported service people.

Genuine GM parts have one of these marks:



ACDelco[®]



Genuine  | **Parts**



 **Accessories**

California Proposition 65 Warning

Most motor vehicles, including this one, contain and/or emit chemicals known to the State of California to

cause cancer and birth defects or other reproductive harm. Engine exhaust, many parts and systems, many fluids, and some component wear by-products contain and/or emit these chemicals.

California Perchlorate Materials Requirements

Certain types of automotive applications, such as airbag initiators, safety belt pretensioners, and lithium batteries contained in Remote Keyless Entry transmitters, may contain perchlorate materials. Special handling may be necessary. For additional information, see www.dtsc.ca.gov/hazardouswaste/perchlorate.

Accessories and Modifications

Adding non-dealer accessories or making modifications to the vehicle can affect vehicle performance and safety, including such things as airbags, braking, stability, ride and

handling, emissions systems, aerodynamics, durability, and electronic systems like antilock brakes, traction control, and stability control. These accessories or modifications could even cause malfunction or damage not covered by the vehicle warranty.

Damage to vehicle components resulting from modifications or the installation or use of non-GM certified parts, including control module or software modifications, is not covered under the terms of the vehicle warranty and may affect remaining warranty coverage for affected parts.

GM Accessories are designed to complement and function with other systems on the vehicle. See your dealer to accessorize the vehicle using genuine GM Accessories installed by a dealer technician.

Also, see *Adding Equipment to the Airbag-Equipped Vehicle* on page 3-35.

Vehicle Checks

Doing Your Own Service Work

Warning

It can be dangerous to work on your vehicle if you do not have the proper knowledge, service manual, tools, or parts. Always follow owner manual procedures and consult the service manual for your vehicle before doing any service work.

If doing some of your own service work, use the proper service manual. It tells you much more about how to service the vehicle than this manual can. To order the proper service manual, see *Service Publications Ordering Information* on page 13-11.

This vehicle has an airbag system. Before attempting to do your own service work, see *Servicing the Airbag-Equipped Vehicle* on page 3-34.

Keep a record with all parts receipts and list the mileage and the date of any service work performed. See *Maintenance Records* on page 11-14.

Caution

Even small amounts of contamination can cause damage to vehicle systems. Do not allow contaminants to contact the fluids, reservoir caps, or dipsticks.

10-4 Vehicle Care

Hood

To open the hood:



1. Pull the hood release handle with this symbol on it. It is under the instrument panel on the driver side of the vehicle.

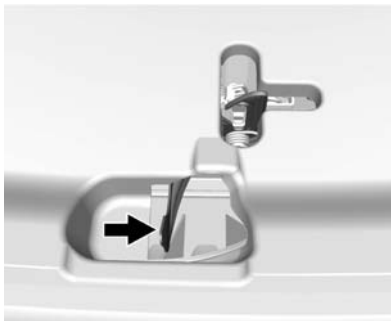

2. At the front of the vehicle, pull up on the center of the hood, and push the secondary hood release to the right.
 3. After you have partially lifted the hood, gas struts will automatically take over to lift and hold the hood in the fully open position.
- Before closing the hood, be sure all filler caps are on properly.
- Pull the hood down to close. Lower the hood until the lifting pressure of the strut is reduced. Then allow the hood to fall and latch into place under its own weight. Check to make sure the hood is closed. If the hood does not fully latch, gently push the hood down at the front and center of the hood until it is completely latched.

Engine Compartment Overview

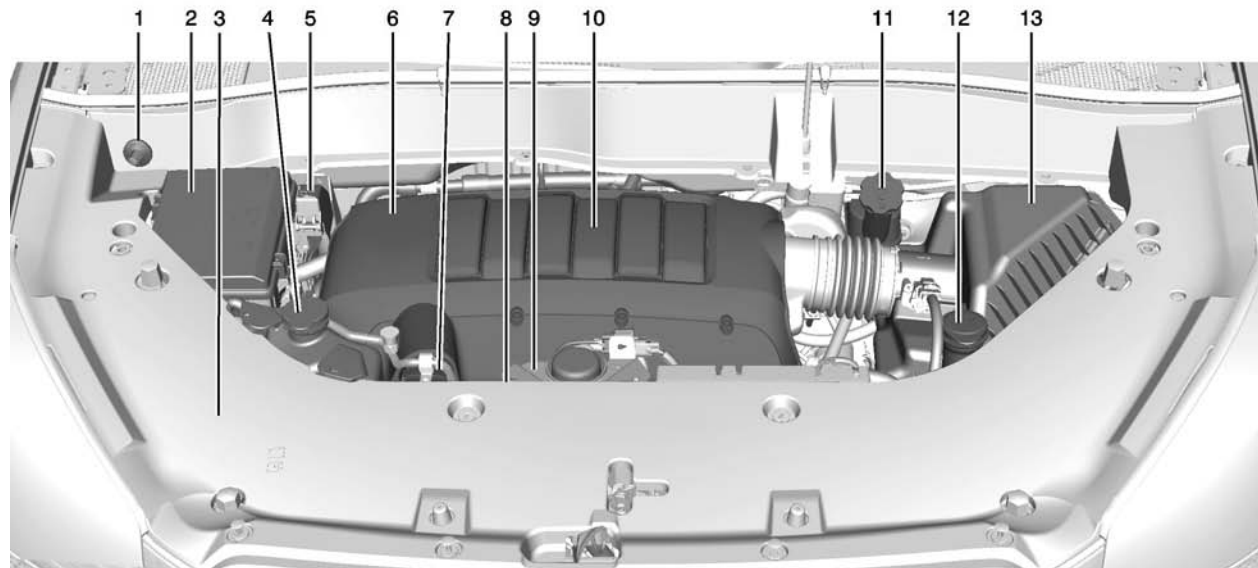

10-6 Vehicle Care

1. Remote Negative (-) Terminal. See *Jump Starting* on page 10-67.
2. Engine Compartment Fuse Block on page 10-29.
3. Radiator Pressure Cap (Out of View). See *Cooling System* on page 10-12.
4. Engine Coolant Recovery Cap. See *Cooling System* on page 10-12.
5. Remote Positive (+) Terminal. See *Jump Starting* on page 10-67.
6. Power Steering Reservoir and Cap (Under Engine Cover). See *Power Steering Fluid* on page 10-19.
7. Engine Oil Fill Cap. See “When to Add Engine Oil” under *Engine Oil* on page 10-7.
8. Engine Oil Dipstick (Out of View). See “Checking Engine Oil” under *Engine Oil* on page 10-7.
9. Engine Cooling Fans (Out of View). See *Cooling System* on page 10-12.
10. Engine Cover on page 10-6.
11. Brake Fluid Reservoir. See “Brake Fluid” under *Brakes* on page 10-20.
12. Windshield Washer Fluid Reservoir. See “Adding Washer Fluid” under *Washer Fluid* on page 10-19.
13. Engine Air Cleaner/Filter on page 10-11.

Engine Cover

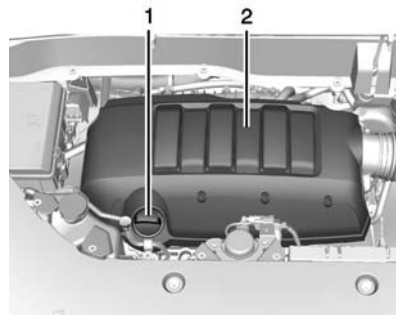

1. Oil Fill Cap
2. Engine Cover

To remove:

1. Remove the oil fill cap (1).
2. Raise the engine cover (2) to release it from the retainers.
3. Lift and remove the engine cover.
4. Reverse Steps 1–3 to reinstall engine cover.

Engine Oil

To ensure proper engine performance and long life, careful attention must be paid to engine oil. Following these simple, but important steps will help protect your investment:

- Always use engine oil approved to the proper specification and of the proper viscosity grade. See “Selecting the Right Engine Oil” in this section.
- Check the engine oil level regularly and maintain the proper oil level. See “Checking Engine Oil” and “When to Add Engine Oil” in this section.
- Change the engine oil at the appropriate time. See *Engine Oil Life System* on page 10-9.
- Always dispose of engine oil properly. See “What to Do with Used Oil” in this section.

Checking Engine Oil

It is a good idea to check the engine oil level at each fuel fill. In order to get an accurate reading, the vehicle must be on level ground. The engine oil dipstick handle is a loop. See *Engine Compartment Overview* on page 10-5 for the location of the engine oil dipstick.

Obtaining an accurate oil level reading is essential:

1. If the engine has been running recently, turn off the engine and allow several minutes for the oil to drain back into the oil pan. Checking the oil level too soon after engine shutoff will not provide an accurate oil level reading.

Warning

The engine oil dipstick handle may be hot; it could burn you. Use a towel or glove to touch the dipstick handle.

2. Pull out the dipstick and wipe it with a clean paper towel or cloth, then push it back in all the way. Remove it again, keeping the tip down, and check the level.

When to Add Engine Oil



If the oil is below the cross-hatched area at the tip of the dipstick, add 1 L (1 qt) of the recommended oil and then recheck the level. See “Selecting the Right Engine Oil” in this section for an explanation of what kind of oil to use. For engine oil crankcase capacity, see *Capacities and Specifications* on page 12-2.

Caution

Do not add too much oil. Oil levels above or below the acceptable operating range shown on the dipstick are harmful to the engine. If you find that you have an oil level above the operating range, i.e., the engine has so much oil that the oil level gets above the cross-hatched area that shows the proper operating range, the engine could be damaged. You should drain out the excess oil or limit driving of the vehicle and seek a service professional to remove the excess amount of oil.

See *Engine Compartment Overview* on page 10-5 for the location of the engine oil fill cap.

Add enough oil to put the level somewhere in the proper operating range. Push the dipstick all the way back in when through.

Selecting the Right Engine Oil

Selecting the right engine oil depends on both the proper oil specification and viscosity grade. See *Recommended Fluids and Lubricants* on page 11-12.

Specification

Use and ask for licensed engine oils with the dexos1[®] approved certification mark. Engine oils meeting the requirements for the vehicle should have the dexos1 approved certification mark. This certification mark indicates that the oil has been approved to the dexos1 specification. See www.gmdexos.com.



Caution

Failure to use the recommended engine oil can result in engine damage not covered by the vehicle warranty. Check with your dealer or service provider on whether the oil is approved to the dexos1 specification.

Viscosity Grade

Use SAE 5W-30 viscosity grade engine oil.

Cold Temperature Operation: In an area of extreme cold, where the temperature falls below -29°C (-20°F), an SAE 0W-30 oil may be used. An oil of this viscosity grade will provide easier cold starting for the engine at extremely low temperatures. When selecting an oil of the appropriate viscosity grade, always select an oil of the correct specification. See “Specification” earlier in this section for more information.

Engine Oil Additives/Engine Oil Flushes

Do not add anything to the oil. The recommended oils with the dexos specification and displaying the dexos certification mark are all that is needed for good performance and engine protection.

Engine oil system flushes are not recommended and could cause engine damage not covered by the vehicle warranty.

What to Do with Used Oil

Used engine oil contains certain elements that can be unhealthy for your skin and could even cause cancer. Do not let used oil stay on your skin for very long. Clean your skin and nails with soap and water, or a good hand cleaner. Wash or properly dispose of clothing or rags containing used engine oil. See the manufacturer's warnings about the use and disposal of oil products.

Used oil can be a threat to the environment. If you change your own oil, be sure to drain all the oil from the filter before disposal. Never dispose of oil by putting it in the trash or pouring it on the ground, into sewers, or into streams or bodies of water. Recycle it by taking it to a place that collects used oil.

Engine Oil Life System

When to Change Engine Oil

This vehicle has a computer system that indicates when to change the engine oil and filter. This is based on a combination of factors which include engine revolutions, engine temperature, and miles driven. Based on driving conditions, the mileage at which an oil change is indicated can vary considerably. For the oil life system to work properly, the system must be reset every time the oil is changed.

When the system has calculated that oil life has been diminished, it indicates that an oil change is

necessary. A CHANGE ENGINE OIL SOON message comes on. Change the oil as soon as possible within the next 1 000 km (600 mi). It is possible that, if driving under the best conditions, the oil life system might indicate that an oil change is not necessary for up to a year. The engine oil and filter must be changed at least once a year and, at this time, the system must be reset. Your dealer has trained service people who will perform this work and reset the system. It is also important to check the oil regularly over the course of an oil drain interval and keep it at the proper level.

If the system is ever reset accidentally, the oil must be changed at 5 000 km (3,000 mi) since the last oil change. Remember to reset the oil life system whenever the oil is changed.

How to Reset the Engine Oil Life System

Reset the system whenever the engine oil is changed so that the system can calculate the next engine oil change. To reset the system:

If the vehicle does not have Driver Information Center (DIC) buttons:

1. Turn the ignition to ON/RUN, with the engine off. The vehicle must be in P (Park) to access this display. Press the trip odometer reset stem until OIL LIFE REMAINING displays.
2. Press and hold the trip odometer reset stem until OIL LIFE REMAINING shows "100%." Three chimes sound and the CHANGE ENGINE OIL SOON message goes off.
3. Turn the key to LOCK/OFF.

If the CHANGE ENGINE OIL SOON message comes back on when the vehicle is started, the

engine oil life system has not been reset. Repeat the procedure.

If the vehicle has Driver Information Center (DIC) buttons:

1. Turn the ignition to ON/RUN, with the engine off.
2. Press the vehicle information button until OIL LIFE REMAINING displays.
3. Press and hold the set/reset button until "100%" is displayed. Three chimes sound and the CHANGE ENGINE OIL SOON message goes off.
4. Turn the key to LOCK/OFF.

If the CHANGE ENGINE OIL SOON message comes back on when the vehicle is started, the engine oil life system has not been reset. Repeat the procedure.

Automatic Transmission Fluid

It is not necessary to check the transmission fluid level. A transmission fluid leak is the only reason for fluid loss. If a leak occurs, take the vehicle to the dealer and have it repaired as soon as possible.

Change the fluid at the intervals listed in *Maintenance Schedule on page 11-2*, and be sure to use the transmission fluid listed in *Recommended Fluids and Lubricants on page 11-12*.

Caution

Use of the incorrect automatic transmission fluid may damage the vehicle, and the damage may not be covered by the vehicle warranty. Always use the automatic transmission fluid listed in *Recommended Fluids and Lubricants on page 11-12*.

The transmission fluid will not reach the end of the dipstick unless the transmission is at operating temperature. If you need to check the transmission fluid level, please take the vehicle to your dealer.

Engine Air Cleaner/Filter

When to Inspect the Engine Air Cleaner/Filter

Inspect the air cleaner/filter at the scheduled maintenance intervals and replace it at the first oil change after each 80 000 km (50,000 mile) interval. See *Maintenance Schedule on page 11-2*. If driving in dusty/dirty conditions, inspect the filter at each engine oil change.

See *Engine Compartment Overview on page 10-5* for the location of the engine air cleaner/filter.

How to Inspect the Engine Air Cleaner/Filter

To inspect the air cleaner/filter, remove the filter from the vehicle and lightly shake the filter (away

from vehicle) to release loose dust and dirt. If the filter remains covered with dirt, a new filter is required.

To inspect or replace the engine air cleaner/filter:

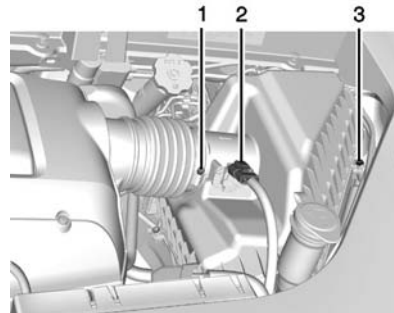

1. Air Duct Clamp
 2. Electrical Connector
 3. Screws
1. Loosen the air duct clamp (1).
 2. Disconnect the electrical connector (2).
 3. Remove the screws (3) and lift the cover assembly.

4. Inspect or replace the air cleaner/filter.
5. Reverse Steps 1–4 to reinstall the housing cover and reconnect the electrical connector to the sensor.

Warning

Operating the engine with the air cleaner/filter off can cause you or others to be burned. The air cleaner not only cleans the air; it helps to stop flames if the engine backfires. Use caution when working on the engine and do not drive with the air cleaner/filter off.

Caution

If the air cleaner/filter is off, dirt can easily get into the engine, which could damage it. Always have the air cleaner/filter in place when you are driving.

Cooling System

The cooling system allows the engine to maintain the correct working temperature.

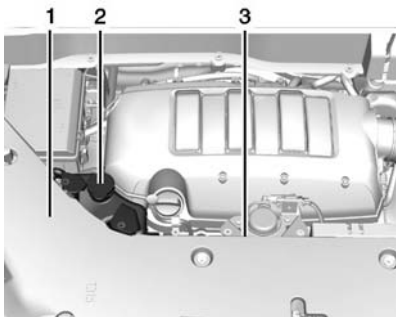

1. Radiator Pressure Cap (Under Sight Shield)
2. Engine Coolant Recovery Tank
3. Engine Cooling Fans (Out of View)

Warning

An electric engine cooling fan under the hood can start up even when the engine is not running and can cause injury. Keep hands, clothing, and tools away from any underhood electric fan.

Warning

Heater and radiator hoses, and other engine parts, can be very hot. Do not touch them. If you do, you can be burned.

Do not run the engine if there is a leak. If you run the engine, it could lose all coolant. That could cause an engine fire, and you could be burned. Get any leak fixed before you drive the vehicle.

Caution

Using coolant other than DEX-COOL[®] can cause premature engine, heater core, or radiator corrosion. In addition, the engine coolant could require changing sooner. Any repairs would not be covered by the vehicle warranty. Always use DEX-COOL (silicate-free) coolant in the vehicle.

Engine Coolant

The cooling system in the vehicle is filled with DEX-COOL[®] engine coolant. See *Maintenance Schedule* on page 11-2 and *Recommended Fluids and Lubricants* on page 11-12.

The following explains the cooling system and how to check and add coolant when it is low. If there is a problem with engine overheating, see *Engine Overheating* on page 10-16.

What to Use **Warning**

Adding only plain water or some other liquid to the cooling system can be dangerous. Plain water and other liquids, can boil before the proper coolant mixture will. The coolant warning system is set for the proper coolant mixture. With plain water or the wrong mixture, the engine could get too hot but you would not get the overheat warning. The engine could catch fire and you or others could be burned. Use a 50/50 mixture of clean, drinkable water and DEX-COOL coolant.

Use a 50/50 mixture of clean, drinkable water and DEX-COOL coolant. If using this mixture, nothing else needs to be added. This mixture:

- Gives freezing protection down to -37°C (-34°F), outside temperature.
- Gives boiling protection up to 129°C (265°F), engine temperature.
- Protects against rust and corrosion.
- Will not damage aluminum parts.
- Helps keep the proper engine temperature.

 **Caution**

If improper coolant mixture, inhibitors, or additives are used in the vehicle cooling system, the engine could overheat and be damaged. Too much water in the

(Continued)

Caution (Continued)

mixture can freeze and crack engine cooling parts. The repairs would not be covered by the vehicle warranty. Use only the proper mixture of engine coolant for the cooling system. See *Recommended Fluids and Lubricants on page 11-12.*

Never dispose of engine coolant by putting it in the trash, pouring it on the ground, or into sewers, streams, or bodies of water. Have the coolant changed by an authorized service center, familiar with legal requirements regarding used coolant disposal. This will help protect the environment and your health.

Checking Coolant

The vehicle must be on a level surface when checking the coolant level.

10-14 Vehicle Care

Check to see if coolant is visible in the coolant recovery tank. If the coolant inside the coolant recovery tank is boiling, do not do anything else until it cools down. If coolant is visible but the coolant level is not at or above the FULL COLD mark or the FULL COLD ISO symbol mark, add a 50/50 mixture of clean, drinkable water and DEX-COOL coolant at the coolant recovery tank, but be sure the cooling system is cool before this is done. See *Engine Overheating on page 10-16*.



The coolant recovery tank cap has this symbol on it.

When the engine is cold, the coolant level should be at or above the FULL COLD mark or the FULL COLD ISO symbol mark on the recovery tank.

When the engine is hot, the level could be higher than the FULL COLD mark or the FULL COLD ISO symbol mark. If the coolant is below the FULL COLD mark or the FULL COLD ISO symbol mark when the engine is hot, there could be a leak in the cooling system.

If the coolant is low, add the coolant or take the vehicle to your dealer for service.

How to Add Coolant to the Recovery Tank

Warning

You can be burned if you spill coolant on hot engine parts. Coolant contains ethylene glycol and it will burn if the engine parts are hot enough. Do not spill coolant on a hot engine.

Caution

This vehicle has a specific coolant fill procedure. Failure to follow this procedure could cause the engine to overheat and be severely damaged.

If recovery tank is empty, check the coolant level in the radiator before adding coolant to the recovery tank or take the vehicle to the dealer for service. See "How to Add Coolant to the Radiator" later in this section.

If coolant is needed, add the proper DEX-COOL coolant mixture at the coolant recovery tank.

How to Add Coolant to the Radiator

Warning

Steam and scalding liquids from a hot cooling system can blow out and burn you badly. Never turn the cap when the cooling system, including the surge tank pressure cap, is hot. Wait for the cooling system and surge tank pressure cap to cool.

If coolant is needed, add the proper mixture directly to the radiator, but be sure the cooling system is cool before this is done. Then check the recovery tank and add coolant if needed.

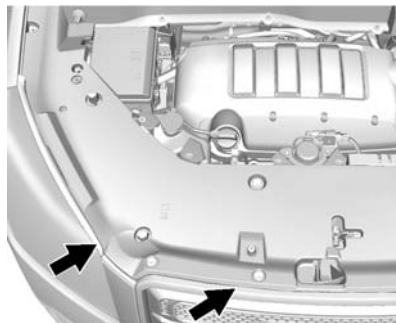

1. Detach the fasteners and lift off the panel that covers the radiator cap.



2. Remove the radiator pressure cap when the cooling system, including the upper radiator hose, is no longer hot. Turn the pressure cap slowly counterclockwise about one full turn.

If a hiss is heard, wait for that to stop. A hiss means there is still some pressure left in the system.

3. Keep turning the pressure cap slowly and remove it.
4. Fill the radiator to the base of the filler neck with the proper DEX-COOL coolant mixture.

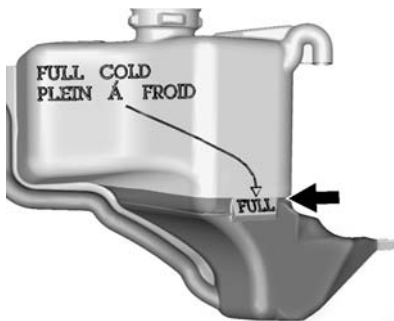

5. Fill the coolant recovery tank to the FULL COLD mark or to the FULL COLD ISO symbol mark.

6. Reinstall the cap on the coolant recovery tank but leave the radiator pressure cap off.
7. Start the engine and let it run until the upper radiator hose feels warm. Any time during this procedure, watch out for the engine cooling fans.
8. If the coolant level inside the radiator filler neck is low, add more of the proper DEX-COOL coolant mixture through the filler neck until the level is back up to the base of the filler neck.
9. Replace the pressure cap tightly. At any time during this procedure if coolant begins to flow out of the filler neck, reinstall the pressure cap.

Caution

If the pressure cap is not tightly installed, coolant loss and possible engine damage may occur. Be sure the cap is properly and tightly secured.

Engine Overheating

The vehicle has several indicators to warn of engine overheating.

There is an engine coolant temperature gauge on the instrument panel cluster. See *Engine Coolant Temperature Gauge on page 5-14*.

The vehicle may also display an ENGINE OVERHEATED IDLE ENGINE and ENGINE OVERHEATED STOP ENGINE message in the Driver Information Center (DIC). See *Engine Cooling System Messages on page 5-36*.

You may decide not to lift the hood when this warning appears, but instead get service help right away. See *Roadside Assistance Program* on page 13-5.

If you do decide to lift the hood, make sure the vehicle is parked on a level surface.

Then check to see if the engine cooling fans are running. If the engine is overheating, both fans should be running. If they are not, do not continue to run the engine and have the vehicle serviced.

 **Caution**

Running the engine without coolant may cause damage or a fire. Vehicle damage would not be covered by the vehicle warranty. See *Overheated Engine Protection Operating Mode* on page 10-18 for information on driving to a safe place in an emergency.

If Steam Is Coming from the Engine Compartment

 **Warning**

Steam from an overheated engine can burn you badly, even if you just open the hood. Stay away from the engine if you see or hear steam coming from it. Turn it off and get everyone away from the vehicle until it cools down. Wait until there is no sign of steam or coolant before you open the hood.

If you keep driving when the vehicles engine is overheated, the liquids in it can catch fire. You or others could be badly burned. Stop the engine if it overheats, and get out of the vehicle until the engine is cool.

(Continued)

Warning (Continued)

See *Overheated Engine Protection Operating Mode* on page 10-18 for information on driving to a safe place in an emergency.

If No Steam Is Coming from the Engine Compartment

If an engine overheat warning is displayed but no steam can be seen or heard, the problem may not be too serious. Sometimes the engine can get a little too hot when the vehicle:

- Climbs a long hill on a hot day.
- Stops after high-speed driving.
- Idles for long periods in traffic.
- Tows a trailer.

10-18 Vehicle Care

If the overheat warning is displayed with no sign of steam:

1. Turn the air conditioning off.
2. Turn the heater on to the highest temperature and to the highest fan speed. Open the windows as necessary.
3. When it is safe to do so, pull off the road, shift to P (Park) or N (Neutral), and let the engine idle.

If the temperature overheat gauge is no longer in the overheat zone or an overheat warning no longer displays, the vehicle can be driven. Continue to drive the vehicle slow for about 10 minutes. Keep a safe vehicle distance from the car in front of you. If the warning does not come back on, continue to drive normally and have the cooling system checked for proper fill and function.

If the warning continues, pull over, stop, and park the vehicle right away.

If there is no sign of steam, idle the engine for three minutes while parked. If the warning is still displayed, turn off the engine until it cools down. Also, see “Overheated Engine Protection Operating Mode” next in this section.

Overheated Engine Protection Operating Mode

This emergency operating mode lets the vehicle be driven to a safe place in an emergency situation. If an overheated engine condition exists, an overheat protection mode which alternates firing groups of cylinders helps prevent engine damage. In this mode, there is a significant loss in power and engine performance. The temperature gauge indicates an overheat condition exists. Driving extended distances and/or towing a trailer in the overheat protection mode should be avoided.

Caution

After driving in the overheated engine protection operating mode, the engine oil will be severely degraded. Any repairs performed before the engine is cool may cause engine damage. Allow the engine to cool before attempting any repair. Repair the cause of coolant loss, change the oil, and reset the oil life system. See *Engine Oil* on page 10-7.

Power Steering Fluid



The power steering fluid reservoir is under the engine cover on the passenger side of the vehicle. See *Engine Compartment Overview on page 10-5* for reservoir location.

When to Check Power Steering Fluid

It is not necessary to regularly check power steering fluid unless you suspect there is a leak in the system or you hear an unusual noise. A fluid loss in this system could indicate a problem. Have the system inspected and repaired.

How to Check Power Steering Fluid

To check the power steering fluid:

1. Turn the key off and let the engine compartment cool down.
2. Remove the engine cover. See *Engine Cover on page 10-6*.
3. Wipe the cap and the top of the reservoir clean.
4. Unscrew the cap and wipe the dipstick with a clean rag.
5. Replace the cap and completely tighten it.
6. Remove the cap again and look at the fluid level on the dipstick.

The fluid level should be somewhere between the MAX and MIN line on the dipstick in room temperature. If the fluid is on or below the MIN line, add fluid close to the MAX line.

What to Use

To determine what kind of fluid to use, see *Recommended Fluids and Lubricants on page 11-12*. Always use the proper fluid.

Caution

Use of the incorrect fluid may damage the vehicle and the damages may not be covered by the vehicle warranty. Always use the correct fluid listed in *Recommended Fluids and Lubricants on page 11-12*.

Washer Fluid

What to Use

When adding windshield washer fluid, be sure to read the manufacturer's instructions before use. If the vehicle will be operating in an area where the temperature may fall below freezing, use a fluid that has sufficient protection against freezing.

Adding Washer Fluid

When the windshield washer fluid reservoir is low, a WASHER FLUID LOW ADD FLUID message will be displayed on the Driver Information Center (DIC). See *Washer Fluid Messages on page 5-44*.



Open the cap with the washer symbol on it. Add washer fluid until the tank is full. See *Engine Compartment Overview on page 10-5* for reservoir location.

Caution

- Do not use engine coolant (antifreeze) in the windshield washer. It can damage the windshield washer system and paint.
- Do not mix water with ready-to-use washer fluid. Water can cause the solution to freeze and damage the washer fluid tank and other parts of the washer system.
- When using concentrated washer fluid, follow the manufacturer instructions for adding water.
- Fill the washer fluid tank only three-quarters full when it is very cold. This allows for fluid expansion if freezing occurs, which could damage the tank if it is completely full.

Brakes

This vehicle has disc brakes. Disc brake pads have built-in wear indicators that make a high-pitched warning sound when the brake pads are worn and new pads are needed. The sound can come and go or be heard all the time when the vehicle is moving, except when applying the brake pedal firmly.

Warning

The brake wear warning sound means that soon the brakes will not work well. That could lead to a crash. When the brake wear warning sound is heard, have the vehicle serviced.

Caution

Continuing to drive with worn-out brake pads could result in costly brake repair.

Some driving conditions or climates can cause a brake squeal when the brakes are first applied or lightly applied. This does not mean something is wrong with the brakes.

Properly torqued wheel nuts are necessary to help prevent brake pulsation. When tires are rotated, inspect brake pads for wear and evenly tighten wheel nuts in the proper sequence to torque specifications. See *Capacities and Specifications on page 12-2*.

Brake pads should be replaced as complete sets.

Brake Pedal Travel

See your dealer if the brake pedal does not return to normal height, or if there is a rapid increase in pedal travel. This could be a sign that brake service might be required.

Brake Adjustment

Every time the brakes are applied, with or without the vehicle moving, the brakes adjust for wear.

Replacing Brake System Parts

The braking system on a vehicle is complex. Its many parts have to be of top quality and work well together if the vehicle is to have really good braking. The vehicle was designed and tested with top-quality brake parts. When parts of the braking system are replaced, be sure to get new, approved replacement parts. If this is not done, the brakes might not work properly. For example, installing disc brake pads that are wrong for the vehicle, can change the balance between the front and rear brakes — for the worse. The braking performance expected can change in many other ways if the wrong replacement brake parts are installed.

Brake Fluid



The brake master cylinder reservoir is filled with DOT 3 brake fluid as indicated on the reservoir cap. See *Engine Compartment Overview on page 10-5* for the location of the reservoir.

There are only two reasons why the brake fluid level in the reservoir might go down:

- The brake fluid level goes down because of normal brake lining wear. When new linings are installed, the fluid level goes back up.

10-22 Vehicle Care

- A fluid leak in the brake hydraulic system can also cause a low fluid level. Have the brake hydraulic system fixed, since a leak means that sooner or later the brakes will not work well.

Do not top off the brake fluid. Adding fluid does not correct a leak. If fluid is added when the linings are worn, there will be too much fluid when new brake linings are installed. Add or remove brake fluid, as necessary, only when work is done on the brake hydraulic system.

Warning

If too much brake fluid is added, it can spill on the engine and burn, if the engine is hot enough. You or others could be burned, and the vehicle could be damaged. Add brake fluid only when work is done on the brake hydraulic system.

When the brake fluid falls to a low level, the brake warning light comes on. See *Brake System Warning Light* on page 5-20.

What to Add

Use only new DOT 3 brake fluid from a sealed container. See *Recommended Fluids and Lubricants* on page 11-12.

Always clean the brake fluid reservoir cap and the area around the cap before removing it. This helps keep dirt from entering the reservoir.

Warning

With the wrong kind of fluid in the brake hydraulic system, the brakes might not work well. This could cause a crash. Always use the proper brake fluid.

Caution

- Using the wrong fluid can badly damage brake hydraulic system parts. For example, just a few drops of mineral-based oil, such as engine oil, in the brake hydraulic system can damage brake hydraulic system parts so badly that they will have to be replaced. Do not let someone put in the wrong kind of fluid.
- If brake fluid is spilled on the vehicle's painted surfaces, the paint finish can be damaged. Be careful not to spill brake fluid on the vehicle. If you do, wash it off immediately.

Battery

Refer to the replacement number on the original battery label when a new battery is needed.

Warning

Battery posts, terminals, and related accessories contain lead and lead compounds, chemicals known to the State of California to cause cancer and reproductive harm. Wash hands after handling.

Vehicle Storage

Warning

Batteries have acid that can burn you and gas that can explode. You can be badly hurt if you are not careful. See *Jump Starting on page 10-67* for tips on working around a battery without getting hurt.

Infrequent Usage: Remove the black, negative (-) cable from the battery to keep the battery from running down.

Extended Storage: Remove the black, negative (-) cable from the battery or use a battery trickle charger.

All-Wheel Drive

Transfer case fluid does not require checking unless there is a fluid leak or unusual noise. If required, have the transfer case serviced by your dealer.

Starter Switch Check

Warning

When you are doing this inspection, the vehicle could move suddenly. If the vehicle moves, you or others could be injured.

1. Before starting this check, be sure there is enough room around the vehicle.
2. Apply both the parking brake and the regular brake.

Do not use the accelerator pedal, and be ready to turn off the engine immediately if it starts.
3. Try to start the engine in each gear. The vehicle should start only in P (Park) or N (Neutral). If the vehicle starts in any other position, contact your dealer for service.

Automatic Transmission Shift Lock Control Function Check

 **Warning**

When you are doing this inspection, the vehicle could move suddenly. If the vehicle moves, you or others could be injured.

1. Before starting this check, be sure there is enough room around the vehicle. It should be parked on a level surface.
2. Apply the parking brake. Be ready to apply the regular brake immediately if the vehicle begins to move.

3. With the engine off, turn the ignition on, but do not start the engine. Without applying the regular brake, try to move the shift lever out of P (Park) with normal effort. If the shift lever moves out of P (Park), contact your dealer for service.

Ignition Transmission Lock Check

While parked and with the parking brake set, try to turn the ignition to LOCK/OFF in each shift lever position.

- The ignition should turn to LOCK/OFF only when the shift lever is in P (Park).
- The ignition key should come out only in LOCK/OFF.

Contact your dealer if service is required.

Park Brake and P (Park) Mechanism Check

 **Warning**

When you are doing this check, the vehicle could begin to move. You or others could be injured and property could be damaged. Make sure there is room in front of the vehicle in case it begins to roll. Be ready to apply the regular brake at once should the vehicle begin to move.

Park on a fairly steep hill, with the vehicle facing downhill. Keeping your foot on the regular brake, set the parking brake.

- To check the parking brake's holding ability: With the engine running and the transmission in N (Neutral), slowly remove foot pressure from the regular brake pedal. Do this until the vehicle is held by the parking brake only.

- To check the P (Park) mechanism's holding ability: With the engine running, shift to P (Park). Then release the parking brake followed by the regular brake.

Contact your dealer if service is required.

Wiper Blade Replacement

Front Wiper Blade

Windshield wiper blades should be inspected for wear or cracking. See *Maintenance Schedule on page 11-2*.

Replacement blades come in different types and are removed in different ways. For the proper type and size, see *Maintenance Replacement Parts on page 11-13*.

To replace the wiper blade assembly:

1. Pull the windshield wiper assembly away from the windshield.

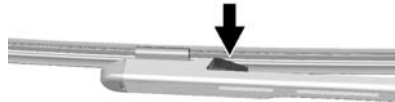

2. Squeeze the tabs on each side of the wiper blade assembly and slide the assembly off the end of the wiper arm.

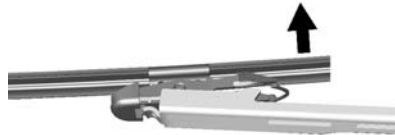

3. Install the new blade onto the arm connector and make sure the tabs are fully set in the locked position.

Allowing the wiper blade arm to touch the windshield when no wiper blade is installed could damage the windshield. Any damage that occurs would not

be covered by your warranty. Do not allow the wiper blade arm to touch the windshield.

4. Repeat the steps for the other blade.

Rear Wiper Blade

To replace the rear wiper blade:

1. Pull the wiper blade assembly away from the backglass.

The rear wiper blade will not lock in a vertical position so care should be used when pulling it away from the vehicle.

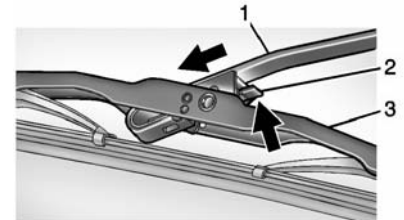

2. Push the release lever (2) to disengage the hook and push the wiper arm (1) out of the blade assembly (3).
3. Push the new blade assembly securely in the wiper arm hook until the release lever clicks into place.
4. Return the wiper arm and blade assembly to the rest position on the glass.

Headlamp Aiming

Headlamp aim has been preset and should need no further adjustment.

If the vehicle is damaged in a crash, the headlamp aim may be affected. If adjustment to the headlamps is necessary, see your dealer.

Bulb Replacement

For the proper type of replacement bulbs, see *Replacement Bulbs on page 10-28*.

For any bulb-changing procedure not listed in this section, contact your dealer.

Taillamps, Turn Signal, and Stoplamps

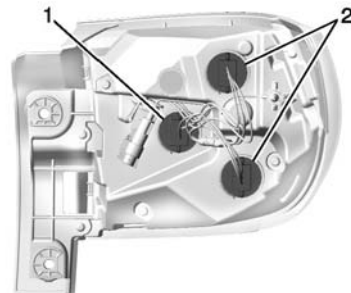

1. Turn Signal Lamp
2. Stoplamp/Taillamp

To replace one of these bulbs:

1. Open the liftgate. See *Liftgate on page 2-8*.
2. Remove the convenience net, if the vehicle has one.

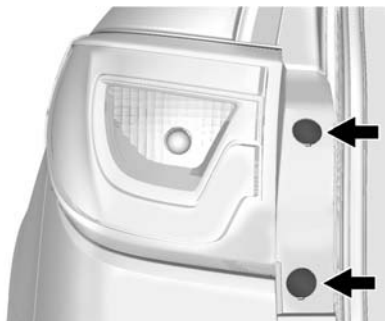

3. Remove the two taillamp screw covers.
4. Remove the two screws holding the taillamp assembly in place.
5. Pull out the taillamp assembly.

6. Turn the bulb socket counterclockwise and pull it straight out to remove it from the taillamp assembly.
7. Pull the old bulb straight out of the bulb socket.
8. Push the new bulb straight into the bulb socket.
9. Push the taillamp assembly back into its original location.

When reinstalling the taillamp assembly, make sure the pin on the taillamp assembly lines up and is inserted correctly into the opening of the vehicle.

10. Reinstall the two screws that hold the taillamp assembly in place.
11. Reinstall the two taillamp screw covers.

License Plate Lamp

To replace one of these bulbs:

1. Open the liftgate. See *Liftgate on page 2-8*.

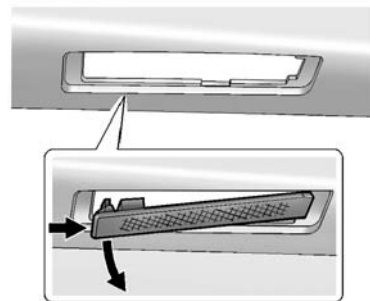

2. Push the left end of the lamp assembly toward the right.
3. Turn the lamp assembly down to remove it from the liftgate.

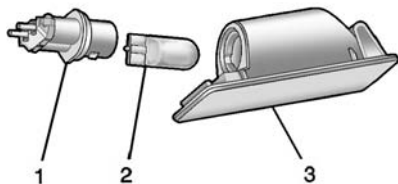

4. Turn the bulb socket (1) counterclockwise to remove it from the lamp assembly (3).
5. Pull the bulb (2) straight out of the bulb socket.
6. Push the replacement bulb straight into the bulb socket and turn the bulb socket clockwise to install it into the lamp assembly.
7. Turn the lamp assembly into the liftgate engaging the clip side first.

8. Push on the lamp side opposite the clip until the lamp assembly snaps into place.

Replacement Bulbs

Exterior Lamp	Bulb Number
License Plate Lamp	194 LL
Rear Turn Signal Lamp	7443 NA
Taillamp/Stop Lamp	7444 LL

For replacement bulbs not listed here, contact your dealer.

Electrical System

High Voltage Devices and Wiring

Warning

Exposure to high voltage can cause shock, burns, and even death. The high voltage components in the vehicle can only be serviced by technicians with special training.

High voltage components are identified by labels. Do not remove, open, take apart, or modify these components. High voltage cable or wiring has orange covering. Do not probe, tamper with, cut, or modify high voltage cable or wiring.

Electrical System Overload

The vehicle has fuses and circuit breakers to protect against an electrical system overload.

When the current electrical load is too heavy, the circuit breaker opens and closes, protecting the circuit until the current load returns to normal or the problem is fixed. This greatly reduces the chance of circuit overload and fire caused by electrical problems.

Fuses and circuit breakers protect power devices in the vehicle.

Replace a bad fuse with a new one of the identical size and rating.

If there is a problem on the road and a fuse needs to be replaced, the same amperage fuse can be borrowed. Choose some feature of the vehicle that is not needed to use and replace it as soon as possible.

Headlamp Wiring

An electrical overload may cause the lamps to go on and off, or in some cases to remain off. Have the headlamp wiring checked right away if the lamps go on and off or remain off.

Windshield Wipers

If the wiper motor overheats due to heavy snow or ice, the windshield wipers will stop until the motor cools and will then restart.

Although the circuit is protected from electrical overload, overload due to heavy snow or ice may cause wiper linkage damage. Always clear ice and heavy snow from the windshield before using the windshield wipers.

If the overload is caused by an electrical problem and not snow or ice, be sure to get it fixed.

Fuses and Circuit Breakers

The wiring circuits in your vehicle are protected from short circuits by a combination of fuses, circuit breakers and fusible thermal links. This greatly reduces the chance of fires caused by electrical problems.

Look at the silver-colored band inside the fuse. If the band is broken or melted, replace the fuse. Be sure you replace a bad fuse with a new one of the identical size and rating.

Fuses of the same amperage can be temporarily borrowed from another fuse location, if a fuse goes out. Replace the fuse as soon as you can.

Engine Compartment Fuse Block

The underhood fuse block is in the engine compartment, on the passenger side of the vehicle.

10-30 Vehicle Care

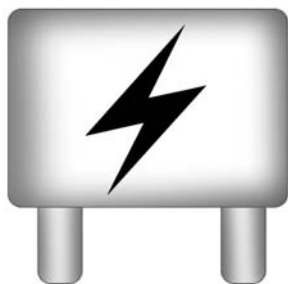

Lift the cover for access to the fuse/relay block.

Caution

Spilling liquid on any electrical component on the vehicle may damage it. Always keep the covers on any electrical component.

To remove fuses, hold the end of the fuse between your thumb and index finger and pull straight out.

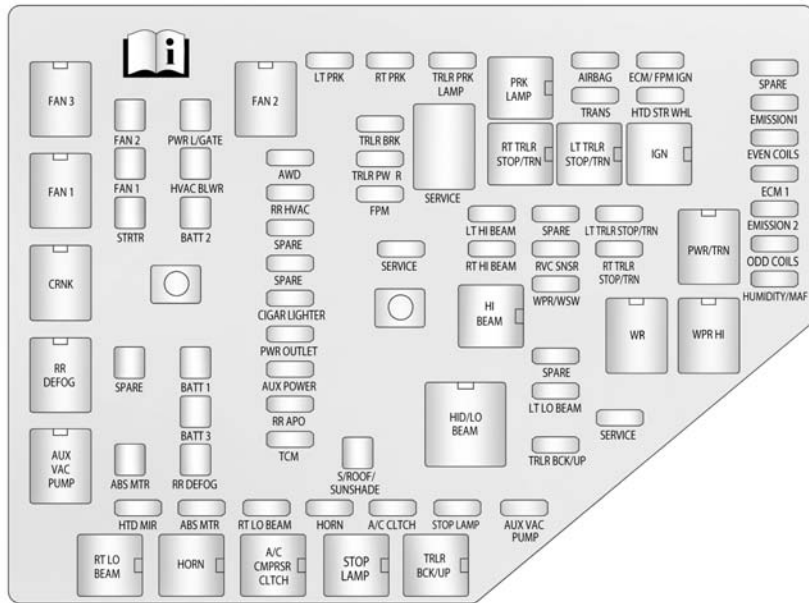

The vehicle may not be equipped with all of the fuses, relays, and features shown.

Fuses	Usage
A/C CLTCH	Air Conditioning Clutch
ABS MTR	Antilock Brake System (ABS) Motor
AIRBAG	Airbag System
AUX POWER	Auxiliary Power
AUX VAC PUMP	Auxiliary Vacuum Pump
AWD	All-Wheel-Drive System
BATT 1	Battery 1
BATT 2	Battery 2
BATT 3	Battery 3
CIGAR LIGHTER	Cigarette Lighter
ECM 1	Engine Control Module 1

Fuses	Usage
ECM/ FPM IGN	Engine Control Module/Fuel Pump Control Module Ignition
EMISSION 1	Emission 1
EMISSION 2	Emission 2
EVEN COILS	Even Injector Coils
FAN 1	Cooling Fan 1
FAN 2	Cooling Fan 2
FPM	Fuel Pump Power Module
HORN	Horn
HTD MIR	Heated Outside Rearview Mirror
HTD STR WHL	Heated Steering Wheel
HUMIDITY/ MAF	Humidity Sensor/ MAF Sensor

Fuses	Usage
HVAC BLWR	Heating, Ventilation, and Air Conditioning Blower
LT HI BEAM	Left High-Beam Headlamp
LT LO BEAM	Left Low-Beam Headlamp
LT PRK	Left Parking Lamp
LT TRLR STOP/TRN	Trailer Left Stoplamp and Turn Signal
ODD COILS	Odd Injector Coils
PWR L/GATE	Power Liftgate
PWR OUTLET	Power Outlet
RR APO	Rear Accessory Power Outlet
RR DEFOG	Rear Defogger
RR HVAC	Rear Climate Control System

10-32 Vehicle Care

Fuses	Usage
RT HI BEAM	Right High-Beam Headlamp
RT LO BEAM	Right Low-Beam Headlamp
RT PRK	Right Parking Lamp
RT TRLR STOP/TRN	Trailer Right Stoplamp and Turn Signal
RVC SNSR	Regulated Voltage Control Sensor
S/ROOF/SUNSHADE	Sunroof
SERVICE	Service Repair
SPARE	Spare
STOP LAMPS	Stoplamps
STRTR	Starter
TCM	Transmission Control Module
TRANS	Transmission

Fuses	Usage
TRLR BCK/UP	Trailer Back-up Lamps
TRLR BRK	Trailer Brake
TRLR PRK LAMP	Trailer Parking Lamps
TRLR PWR	Trailer Power
WPR/WSW	Windshield Wiper/Washer

Relays	Usage
A/C CMPRSR CLTCH	Air Conditioning Compressor Clutch
AUX VAC PUMP	Auxiliary Vacuum Pump
CRNK	Switched Power
FAN 1	Cooling Fan 1
FAN 2	Cooling Fan 2
FAN 3	Cooling Fan 3
HI BEAM	High-Beam Headlamps

Relays	Usage
HID/LO BEAM	High Intensity Discharge (HID) Low-Beam Headlamps
HORN	Horn
IGN	Ignition Main
LT TRLR STOP/TRN	Trailer Left Stoplamp and Turn Signal Lamp
PRK LAMP	Parking Lamp
PWR/TRN	Powertrain
RR DEFOG	Rear Window Defogger
RT LO BEAM	Right Low-Beam Headlamp
RT TRLR STOP/TRN	Trailer Right Stoplamp and Turn Signal Lamp
STOP LAMP	Stop Lamps
TRLR BCK/UP	Trailer Back-up Lamps

Relays	Usage
WPR	Windshield Wiper
WPR HI	Windshield Wiper High Speed

Instrument Panel Fuse Block

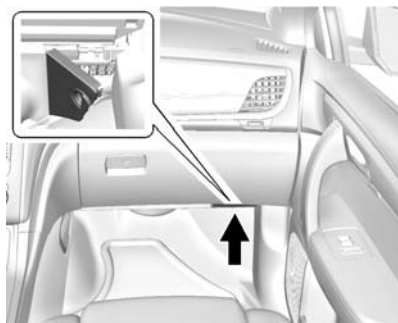

The instrument panel fuse block is under the instrument panel on the passenger side of the vehicle. Pull down on the cover to access the fuse block.



Fuse Side

The vehicle may not be equipped with all of the fuses, relays, and features shown.

Fuses	Usage
#	GMC NON HID = Lo Beam
•	GMC NON HID = High Shutter
••	Chevy = Fog Lamps
•••	Buick China = Rear Fog Lamp
AIRBAG	Airbag
AMP	Amplifier
BCK UP/STOP	Back-up Lamp/ Stoplamp
BCM	Body Control Module
CNSTR VENT	Canister Vent
CTSY	Courtesy Lamps
DR LCK	Door Locks

10-34 Vehicle Care

Fuses	Usage
DRL/ LO BEAM	Daytime Running Lamps Relay/Low Beam Headlamps Relay
DSPLY	Display
FRT WSW	Front Windshield Washer
HTD/ COOL SEAT	Heated/Cooling Seats
HVAC	Heating, Ventilation, and Air Conditioning
INADV PWR INT LAMPS	Inadvertent Power/Interior Light Pipe Lamps
INFOTMNT/ MSM	Infotainment/Memory Seat Module
LT TRN SIG	Driver Side Turn Signal

Fuses	Usage
OBS DET/URS	Rear Park Assist/Side Blind Zone Alert/Forward Collision Alert/Universal Remote System
PDM	Power Mirrors, Liftgate Release
PWR MODE	Power Mode
PWR MIR	Power Mirrors
RDO	Radio
REAR WPR	Rear Wiper
RT TRN SIG	Passenger Side Turn Signal
STR WHL ILLUM	Steering Wheel Illumination
USB CHRGR	USB Charging

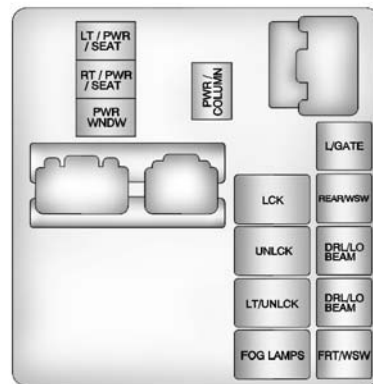

Relay Side

Relays	Usage
LT/ PWR/SEAT	Driver Side Power Seat Relay
RT/ PWR/SEAT	Passenger Side Power Seat Relay
PWR/WNDW	Power Windows Relay
PWR/ COLUMN	Power Steering Column Relay
L/GATE	Liftgate Relay
LCK	Power Lock Relay
REAR/WSW	Rear Window Washer Relay
UNLCK	Power Unlock Relay

Relays	Usage
DRL/ LO BEAM	Daytime Running Lamps Relay/ Low-Beam Headlamps Relay
LT/UNLCK	Driver Side Unlock Relay
DRL/ LO BEAM	Daytime Running Lamps Relay (If Equipped)
FOG LAMPS	Fog Lamps Relay
FRT/WSW	Front Windshield Washer Relay

Wheels and Tires

Tires

Every new GM vehicle has high-quality tires made by a leading tire manufacturer. See the warranty manual for information regarding the tire warranty and where to get service. For additional information refer to the tire manufacturer.

Warning

- Poorly maintained and improperly used tires are dangerous.
- Overloading the tires can cause overheating as a result of too much flexing. There could be a blowout

(Continued)

Warning (Continued)

and a serious crash. See *Vehicle Load Limits on page 9-9*.

- Underinflated tires pose the same danger as overloaded tires. The resulting crash could cause serious injury. Check all tires frequently to maintain the recommended pressure. Tire pressure should be checked when the tires are cold.
- Overinflated tires are more likely to be cut, punctured, or broken by a sudden impact — such as when hitting a pothole. Keep tires at the recommended pressure.

(Continued)

Warning (Continued)

- Worn or old tires can cause a crash. If the tread is badly worn, replace them.
- Replace any tires that have been damaged by impacts with potholes, curbs, etc.
- Improperly repaired tires can cause a crash. Only the dealer or an authorized tire service center should repair, replace, dismount, and mount the tires.
- Do not spin the tires in excess of 56 km/h (35 mph) on slippery surfaces such as snow, mud, ice, etc. Excessive spinning may cause the tires to explode.

All-Season Tires

This vehicle may come with all-season tires. These tires are designed to provide good overall performance on most road surfaces and weather conditions. Original equipment tires designed to GM's specific tire performance criteria have a TPC specification code molded onto the sidewall. Original equipment all-season tires can be identified by the last two characters of this TPC code, which will be "MS."

Consider installing winter tires on the vehicle if frequent driving on snow or ice-covered roads is expected. All-season tires provide adequate performance for most winter driving conditions, but they may not offer the same level of traction or performance as winter tires on snow or ice-covered roads. See *Winter Tires on page 10-37*.

Winter Tires

This vehicle was not originally equipped with winter tires. Winter tires are designed for increased traction on snow and ice-covered roads. Consider installing winter tires on the vehicle if frequent driving on ice or snow covered roads is expected. See your dealer for details regarding winter tire availability and proper tire selection. Also, see *Buying New Tires* on page 10-51.

With winter tires, there may be decreased dry road traction, increased road noise, and shorter tread life. After changing to winter tires, be alert for changes in vehicle handling and braking.

If using winter tires:

- Use tires of the same brand and tread type on all four wheel positions.

- Use only radial ply tires of the same size, load range, and speed rating as the original equipment tires.

Winter tires with the same speed rating as the original equipment tires may not be available for H, V, W, Y, and ZR speed rated tires. If winter tires with a lower speed rating are chosen, never exceed the tire's maximum speed capability.

Summer Tires

This vehicle may come with high performance summer tires. These tires have a special tread and compound that are optimized for maximum dry and wet road performance. This special tread and compound will have decreased performance in cold climates, and on ice and snow. We recommend installing winter tires on the vehicle if frequent driving at temperatures below approximately 5°C (40°F) or on ice or snow covered roads is expected. See *Winter Tires* on page 10-37.

Tire Sidewall Labeling

Useful information about a tire is molded into its sidewall. The examples show a typical passenger vehicle tire and a compact spare tire sidewall.

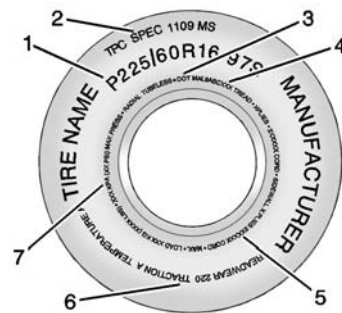

Passenger (P-Metric) Tire Example

(1) Tire Size: The tire size is a combination of letters and numbers used to define a particular tire's width, height, aspect ratio, construction type,

10-38 Vehicle Care

and service description. See the “Tire Size” illustration later in this section.

(2) TPC Spec (Tire Performance Criteria Specification):

Original equipment tires designed to GM's specific tire performance criteria have a TPC specification code molded onto the sidewall. GM's TPC specifications meet or exceed all federal safety guidelines.

(3) DOT (Department of Transportation):

The Department of Transportation (DOT) code indicates that the tire is in compliance with the U.S. Department of Transportation Motor Vehicle Safety Standards.

DOT Tire Date of

Manufacture: The last four digits of the TIN indicate the tire manufactured date. The first two

digits represent the week (01–52) and the last two digits, the year. For example, the third week of the year 2010 would have a four-digit DOT date of 0310.

(4) Tire Identification Number (TIN):

The letters and numbers following the DOT (Department of Transportation) code are the Tire Identification Number (TIN). The TIN shows the manufacturer and plant code, tire size, and date the tire was manufactured. The TIN is molded onto both sides of the tire, although only one side may have the date of manufacture.

(5) Tire Ply Material: The type of cord and number of plies in the sidewall and under the tread.

(6) Uniform Tire Quality Grading (UTQG):

Tire manufacturers are required to grade tires based on three

performance factors: treadwear, traction, and temperature resistance. For more information see *Uniform Tire Quality Grading on page 10-53*.

(7) Maximum Cold Inflation

Load Limit: Maximum load that can be carried and the maximum pressure needed to support that load.

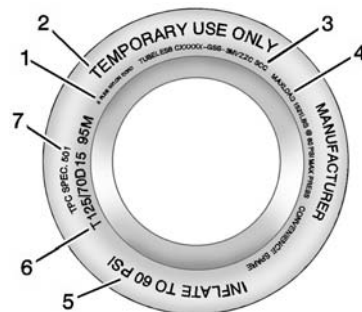

Compact Spare Tire Example

(1) Tire Ply Material: The type of cord and number of plies in the sidewall and under the tread.

(2) Temporary Use Only: The compact spare tire or temporary use tire should not be driven at speeds over 80 km/h (50 mph). The compact spare tire is for emergency use when a regular road tire has lost air and gone flat. If the vehicle has a compact spare tire, see *Compact Spare Tire* on page 10-66 and *If a Tire Goes Flat* on page 10-56.

(3) Tire Identification Number (TIN): The letters and numbers following the DOT (Department of Transportation) code are the Tire Identification Number (TIN). The TIN shows the manufacturer and plant code, tire size, and date the tire was manufactured. The TIN is molded onto both sides of the tire, although only one side may have the date of manufacture.

(4) Maximum Cold Inflation Load Limit: Maximum load that can be carried and the maximum pressure needed to support that load.

(5) Tire Inflation: The temporary use tire or compact spare tire should be inflated to 420 kPa (60 psi). For more information on tire pressure and inflation see *Tire Pressure* on page 10-43.

(6) Tire Size: A combination of letters and numbers define a tire's width, height, aspect ratio, construction type, and service description. The letter T as the first character in the tire size means the tire is for temporary use only.

(7) TPC Spec (Tire Performance Criteria Specification): Original equipment tires designed to GM's specific tire performance

criteria have a TPC specification code molded onto the sidewall. GM's TPC specifications meet or exceed all federal safety guidelines.

Tire Designations

Tire Size

The following is an example of a typical passenger vehicle tire size.

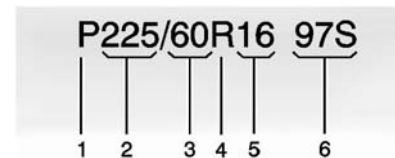

(1) Passenger (P-Metric) Tire: The United States version of a metric tire sizing system. The letter P as the first character in the tire size means a passenger

vehicle tire engineered to standards set by the U.S. Tire and Rim Association.

(2) Tire Width: The three-digit number indicates the tire section width in millimeters from sidewall to sidewall.

(3) Aspect Ratio: A two-digit number that indicates the tire height-to-width measurements. For example, if the tire size aspect ratio is 60, as shown in item 3 of the illustration, it would mean that the tire's sidewall is 60 percent as high as it is wide.

(4) Construction Code: A letter code is used to indicate the type of ply construction in the tire. The letter R means radial ply construction; the letter D means diagonal or bias ply construction; and the letter B means belted-bias ply construction.

(5) Rim Diameter: Diameter of the wheel in inches.

(6) Service Description: These characters represent the load index and speed rating of the tire. The load index represents the load carrying capacity a tire is certified to carry. The speed rating is the maximum speed a tire is certified to carry a load.

Tire Terminology and Definitions

Air Pressure: The amount of air inside the tire pressing outward on each square inch of the tire. Air pressure is expressed in kPa (kilopascal) or psi (pounds per square inch).

Accessory Weight: The combined weight of optional accessories. Some examples of optional accessories are

automatic transmission, power windows, power seats, and air conditioning.

Aspect Ratio: The relationship of a tire's height to its width.

Belt: A rubber coated layer of cords between the plies and the tread. Cords may be made from steel or other reinforcing materials.

Bead: The tire bead contains steel wires wrapped by steel cords that hold the tire onto the rim.

Bias Ply Tire: A pneumatic tire in which the plies are laid at alternate angles less than 90 degrees to the centerline of the tread.

Cold Tire Pressure: The amount of air pressure in a tire, measured in kPa (kilopascal) or psi (pounds per square inch)

before a tire has built up heat from driving. See *Tire Pressure* on page 10-43.

Curb Weight: The weight of a motor vehicle with standard and optional equipment including the maximum capacity of fuel, oil, and coolant, but without passengers and cargo.

DOT Markings: A code molded into the sidewall of a tire signifying that the tire is in compliance with the U.S. Department of Transportation (DOT) Motor Vehicle Safety Standards. The DOT code includes the Tire Identification Number (TIN), an alphanumeric designator which can also identify the tire manufacturer, production plant, brand, and date of production.

GVWR: Gross Vehicle Weight Rating. See *Vehicle Load Limits* on page 9-9.

GAWR FRT: Gross Axle Weight Rating for the front axle. See *Vehicle Load Limits* on page 9-9.

GAWR RR: Gross Axle Weight Rating for the rear axle. See *Vehicle Load Limits* on page 9-9.

Intended Outboard Sidewall: The side of an asymmetrical tire that must always face outward when mounted on a vehicle.

Kilopascal (kPa): The metric unit for air pressure.

Light Truck (LT-Metric) Tire: A tire used on light duty trucks and some multipurpose passenger vehicles.

Load Index: An assigned number ranging from 1 to 279 that corresponds to the load carrying capacity of a tire.

Maximum Inflation Pressure: The maximum air pressure to which a cold tire can be inflated. The maximum air pressure is molded onto the sidewall.

Maximum Load Rating: The load rating for a tire at the maximum permissible inflation pressure for that tire.

Maximum Loaded Vehicle Weight: The sum of curb weight, accessory weight, vehicle capacity weight, and production options weight.

Normal Occupant Weight: The number of occupants a vehicle is designed to seat multiplied by 68 kg (150 lb). See *Vehicle Load Limits* on page 9-9.

Occupant Distribution: Designated seating positions.

Outward Facing Sidewall: The side of an asymmetrical tire that has a particular side that faces outward when mounted on a vehicle. The side of the tire that contains a whitewall, bears white lettering, or bears manufacturer, brand, and/or model name molding that is higher or deeper than the same moldings on the other sidewall of the tire.

Passenger (P-Metric) Tire: A tire used on passenger cars and some light duty trucks and multipurpose vehicles.

Recommended Inflation

Pressure: Vehicle manufacturer's recommended tire inflation pressure as shown on the tire placard. See *Tire Pressure on page 10-43* and *Vehicle Load Limits on page 9-9*.

Radial Ply Tire: A pneumatic tire in which the ply cords that extend to the beads are laid at 90 degrees to the centerline of the tread.

Rim: A metal support for a tire and upon which the tire beads are seated.

Sidewall: The portion of a tire between the tread and the bead.

Speed Rating: An alphanumeric code assigned to a tire indicating the maximum speed at which a tire can operate.

Traction: The friction between the tire and the road surface. The amount of grip provided.

Tread: The portion of a tire that comes into contact with the road.

Treadwear Indicators: Narrow bands, sometimes called wear bars, that show across the tread of a tire when only 1.6 mm (1/16 in) of tread remains. See *When It Is Time for New Tires on page 10-50*.

UTQGS (Uniform Tire Quality Grading Standards): A tire information system that provides consumers with ratings for a tire's traction, temperature, and treadwear. Ratings are determined by tire manufacturers using government testing procedures. The ratings are molded into the sidewall of the tire. See *Uniform Tire Quality Grading on page 10-53*.

Vehicle Capacity Weight: The number of designated seating positions multiplied by 68 kg (150 lb) plus the rated cargo load. See *Vehicle Load Limits on page 9-9*.

Vehicle Maximum Load on the Tire: Load on an individual tire due to curb weight, accessory weight, occupant weight, and cargo weight.

Vehicle Placard: A label permanently attached to a vehicle showing the vehicle capacity weight and the original equipment tire size and recommended inflation pressure. See "Tire and Loading Information Label" under *Vehicle Load Limits on page 9-9*.

Tire Pressure

Tires need the correct amount of air pressure to operate effectively.

Caution

Neither tire underinflation nor overinflation is good. Underinflated tires, or tires that do not have enough air, can result in:

- Tire overloading and overheating which could lead to a blowout.
- Premature or irregular wear.
- Poor handling.
- Reduced fuel economy.

Overinflated tires, or tires that have too much air, can result in:

- Unusual wear.
- Poor handling.
- Rough ride.
- Needless damage from road hazards.

The Tire and Loading Information label on the vehicle indicates the original equipment tires and the correct cold tire inflation pressures. The recommended pressure is the minimum air pressure needed to support the vehicle's maximum load carrying capacity. See *Vehicle Load Limits on page 9-9*.

How the vehicle is loaded affects vehicle handling and ride comfort. Never load the vehicle with more weight than it was designed to carry.

When to Check

Check the tires once a month or more. Do not forget the compact spare, if the vehicle has one. The cold compact spare tire pressure should be at 420 kPa (60 psi). See *Compact Spare Tire on page 10-66*.

How to Check

Use a good quality pocket-type gauge to check tire pressure. Proper tire inflation cannot be determined by looking at the tire. Check the tire inflation pressure when the tires are cold, meaning the vehicle has not been driven for at least three hours or no more than 1.6 km (1 mi).

Remove the valve cap from the tire valve stem. Press the tire gauge firmly onto the valve to get a pressure measurement. If the cold tire inflation pressure matches the recommended pressure on the Tire and Loading Information label, no further adjustment is necessary. If the inflation pressure is low, add air until the recommended pressure is reached. If the inflation pressure is high, press on the metal stem in the center of the tire valve to release air.

Recheck the tire pressure with the tire gauge.

Return the valve caps on the valve stems to prevent leaks and keep out dirt and moisture.

Tire Pressure Monitor System

The Tire Pressure Monitor System (TPMS) uses radio and sensor technology to check tire pressure levels. The TPMS sensors monitor the air pressure in your tires and transmit tire pressure readings to a receiver located in the vehicle.

Each tire, including the spare (if provided), should be checked monthly when cold and inflated to the inflation pressure recommended by the vehicle manufacturer on the vehicle placard or tire inflation pressure label. (If your vehicle has tires of a different size than the size indicated on the vehicle placard or

tire inflation pressure label, you should determine the proper tire inflation pressure for those tires.)

As an added safety feature, your vehicle has been equipped with a tire pressure monitoring system (TPMS) that illuminates a low tire pressure telltale when one or more of your tires is significantly under-inflated.

Accordingly, when the low tire pressure telltale illuminates, you should stop and check your tires as soon as possible, and inflate them to the proper pressure. Driving on a significantly under-inflated tire causes the tire to overheat and can lead to tire failure. Under-inflation also reduces fuel efficiency and tire tread life, and may affect the vehicle's handling and stopping ability.

Please note that the TPMS is not a substitute for proper tire maintenance, and it is the driver's responsibility to maintain correct tire pressure, even if under-inflation has

not reached the level to trigger illumination of the TPMS low tire pressure telltale.

Your vehicle has also been equipped with a TPMS malfunction indicator to indicate when the system is not operating properly. The TPMS malfunction indicator is combined with the low tire pressure telltale. When the system detects a malfunction, the telltale will flash for approximately one minute and then remain continuously illuminated. This sequence will continue upon subsequent vehicle start-ups as long as the malfunction exists.

When the malfunction indicator is illuminated, the system may not be able to detect or signal low tire pressure as intended. TPMS malfunctions may occur for a variety of reasons, including the installation of replacement or alternate tires or wheels on the vehicle that prevent the TPMS from functioning properly.

Always check the TPMS malfunction telltale after replacing one or more tires or wheels on your vehicle to ensure that the replacement or alternate tires and wheels allow the TPMS to continue to function properly.

See *Tire Pressure Monitor Operation* on page 10-45.

See *Radio Frequency Statement* on page 13-12.

Tire Pressure Monitor Operation

This vehicle may have a Tire Pressure Monitor System (TPMS). The TPMS is designed to warn the driver when a low tire pressure condition exists. TPMS sensors are mounted onto each tire and wheel assembly, excluding the spare tire and wheel assembly, if the vehicle has one. The TPMS sensors

monitor the air pressure in the tires and transmits the tire pressure readings to a receiver located in the vehicle.



When a low tire pressure condition is detected, the TPMS illuminates the low tire pressure warning light located on the instrument cluster. If the warning light comes on, stop as soon as possible and inflate the tires to the recommended pressure shown on the tire loading information label. See *Vehicle Load Limits* on page 9-9.

A message to check the pressure in a specific tire displays in the Driver Information Center (DIC). The low tire pressure warning light and the DIC warning message come on at each ignition cycle until the tires are inflated to the correct inflation pressure. Using the DIC, tire pressure levels can be viewed. For additional information and details about the DIC operation and displays see *Driver Information Center (DIC) (With DIC Buttons)* on page 5-25 or *Driver Information Center (DIC) (Without DIC Buttons)* on page 5-31 and *Tire Messages* on page 5-42.

The low tire pressure warning light may come on in cool weather when the vehicle is first started, and then turn off as the vehicle is driven. This could be an early indicator that the air pressure is getting low and needs to be inflated to the proper pressure.

A Tire and Loading Information label shows the size of the original equipment tires and the correct inflation pressure for the tires when they are cold. See *Vehicle Load Limits* on page 9-9, for an example of the Tire and Loading Information label and its location. Also see *Tire Pressure* on page 10-43.

The TPMS can warn about a low tire pressure condition but it does not replace normal tire maintenance. See *Tire Inspection* on page 10-48, *Tire Rotation* on page 10-49 and *Tires* on page 10-35.

Caution

Tire sealant materials are not all the same. A non-approved tire sealant could damage the TPMS sensors. TPMS sensor damage caused by using an incorrect tire sealant is not covered by the vehicle warranty. Always use only
(Continued)

Caution (Continued)

the GM approved tire sealant available through your dealer or included in the vehicle.

TPMS Malfunction Light and Message

The TPMS will not function properly if one or more of the TPMS sensors are missing or inoperable. When the system detects a malfunction, the low tire warning light flashes for about one minute and then stays on for the remainder of the ignition cycle. A DIC warning message displays. The malfunction light and DIC warning message come on at each ignition cycle until the problem is corrected. Some of the conditions that can cause these to come on are:

- One of the road tires has been replaced with the spare tire, if your vehicle has one. The spare tire does not have a

TPMS sensor. The malfunction light and DIC message should go off after the road tire is replaced and the sensor matching process is performed successfully. See "TPMS Sensor Matching Process" later in this section.

- The TPMS sensor matching process was not done or not completed successfully after rotating the tires. The malfunction light and the DIC message should go off after successfully completing the sensor matching process. See "TPMS Sensor Matching Process" later in this section.
- One or more TPMS sensors are missing or damaged. The malfunction light and the DIC message should go off when the TPMS sensors are installed and the sensor matching process is performed successfully. See your dealer for service.

- Replacement tires or wheels do not match the original equipment tires or wheels. Tires and wheels other than those recommended could prevent the TPMS from functioning properly. See *Buying New Tires on page 10-51*.
- Operating electronic devices or being near facilities using radio wave frequencies similar to the TPMS could cause the TPMS sensors to malfunction.

If the TPMS is not functioning properly, it cannot detect or signal a low tire condition. See your dealer for service if the TPMS malfunction light and DIC message comes on and stays on.



TPMS Sensor Matching Process

Each TPMS sensor has a unique identification code. The identification code needs to be matched to a new tire/wheel position after rotating the tires or replacing one or more of the TPMS sensors. The TPMS sensor matching process should also be

performed after replacing a spare tire with a road tire containing the TPMS sensor. The malfunction light and the DIC message should go off at the next ignition cycle. The sensors are matched to the tire/wheel positions, using a TPMS relearn tool, in the following order: driver side front tire, passenger side front tire, passenger side rear tire, and driver side rear. See your dealer for service or to purchase a relearn tool. A TPMS relearn tool can also be purchased. See Tire Pressure Monitor Sensor Activation Tool at www.gmtoolsandequipment.com or call 1-800-GM TOOLS (1-800-468-6657).

There are two minutes to match the first tire/wheel position, and five minutes overall to match all four tire/wheel positions. If it takes longer, the matching process stops and must be restarted.

The TPMS sensor matching process is outlined below:

1. Set the parking brake.
2. Turn the ignition to ON/RUN with the engine off.
3. Press the Remote Keyless Entry (RKE) transmitter's  and  buttons at the same time for approximately five seconds. The horn sounds twice to signal the receiver is in relearn mode and TIRE LEARNING ACTIVE message displays on the DIC screen.
4. Start with the driver side front tire.
5. Place the relearn tool against the tire sidewall, near the valve stem. Then press the button to activate the TPMS sensor. A horn chirp confirms that the sensor identification code has been matched to this tire and wheel position.
6. Proceed to the passenger side front tire, and repeat the procedure in Step 5.
7. Proceed to the passenger side rear tire, and repeat the procedure in Step 5.
8. Proceed to the driver side rear tire, and repeat the procedure in Step 5. The horn sounds two times to indicate the sensor identification code has been matched to the driver side rear tire, and the TPMS sensor matching process is no longer active. The TIRE LEARNING ACTIVE message on the DIC display screen goes off.
9. Turn the ignition to LOCK/OFF.
10. Set all four tires to the recommended air pressure level as indicated on the Tire and Loading Information label.
11. Put the valve caps back on the valve stems.

Tire Inspection

We recommend that the tires, including the spare tire, if the vehicle has one, be inspected for signs of wear or damage at least once a month.

Replace the tire if:

- The indicators at three or more places around the tire can be seen.
- There is cord or fabric showing through the tire's rubber.
- The tread or sidewall is cracked, cut, or snagged deep enough to show cord or fabric.
- The tire has a bump, bulge, or split.

- The tire has a puncture, cut, or other damage that cannot be repaired well because of the size or location of the damage.

Tire Rotation

Tires should be rotated every 12 000 km (7,500 mi). See *Maintenance Schedule* on page 11-2.

Tires are rotated to achieve a uniform wear for all tires. The first rotation is the most important.

Anytime unusual wear is noticed, rotate the tires as soon as possible, check for proper tire inflation pressure, and check for damaged tires or wheels. If the unusual wear continues after the rotation, check the wheel alignment. See *When It Is Time for New Tires* on page 10-50 and *Wheel Replacement* on page 10-55.

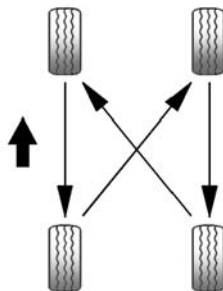

Use this rotation pattern when rotating the tires.

If the vehicle has a compact spare tire, do not include it in the tire rotation.

Adjust the front and rear tires to the recommended inflation pressure on the Tire and Loading Information label after the tires have been rotated. See *Tire Pressure* on page 10-43 and *Vehicle Load Limits* on page 9-9.

Reset the Tire Pressure Monitor System. See *Tire Pressure Monitor Operation* on page 10-45.

Check that all wheel nuts are properly tightened. See “Wheel Nut Torque” under *Capacities and Specifications* on page 12-2.

Warning

Rust or dirt on a wheel, or on the parts to which it is fastened, can make wheel nuts become loose after time. The wheel could come off and cause an accident. When changing a wheel, remove any rust or dirt from places where the wheel attaches to the vehicle. In an emergency, a cloth or a paper towel can be used; however, use a scraper or wire brush later to remove all rust or dirt.

Lightly coat the center of the wheel hub with wheel bearing grease after a wheel change or tire rotation to prevent corrosion or rust build-up. Do not get grease on the flat wheel mounting surface or on the wheel nuts or bolts.

Check that the spare tire, if the vehicle has one, is stored properly. Push, pull, and then try to rotate or turn the tire. If it moves, tighten the cable. See *Tire Changing on page 10-57*.

When It Is Time for New Tires

Factors such as maintenance, temperatures, driving speeds, vehicle loading, and road conditions affect the wear rate of the tires.

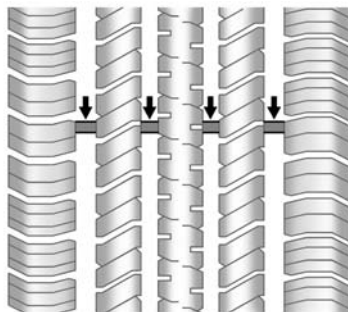

Treadwear indicators are one way to tell when it is time for new tires. Treadwear indicators appear when the tires have only 1.6 mm (1/16 in) or less of tread remaining. See *Tire Inspection on page 10-48* and *Tire Rotation on page 10-49*.

The rubber in tires ages over time. This also applies to the spare tire, if the vehicle has one, even if it is never used. Multiple factors including temperatures, loading conditions, and inflation pressure maintenance affect how fast aging takes place. GM recommends that tires, including the spare if equipped, be replaced after six years, regardless of tread wear. The tire manufacture date is the last four digits of the DOT Tire Identification Number (TIN) which is molded into one side of the tire sidewall. The first two digits represent the week (01–52) and the last two digits, the year. For example, the third week of the year 2010 would have a four-digit DOT date of 0310.

Vehicle Storage

Tires age when stored normally mounted on a parked vehicle. Park a vehicle that will be stored for at least a month in a cool, dry, clean area away from direct sunlight to slow aging. This area should be free of grease, gasoline, or other substances that can deteriorate rubber.

Parking for an extended period can cause flat spots on the tires that may result in vibrations while driving. When storing a vehicle for at least a month, remove the tires or raise the vehicle to reduce the weight from the tires.

Buying New Tires

GM has developed and matched specific tires for the vehicle. The original equipment tires installed were designed to meet General Motors Tire Performance Criteria Specification (TPC Spec) system rating. When

replacement tires are needed, GM strongly recommends buying tires with the same TPC Spec rating.

GM's exclusive TPC Spec system considers over a dozen critical specifications that impact the overall performance of the vehicle, including brake system performance, ride and handling, traction control, and tire pressure monitoring performance. GM's TPC Spec number is molded onto the tire's sidewall near the tire size. If the tires have an all-season tread design, the TPC Spec number will be followed by MS for mud and snow. See *Tire Sidewall Labeling* on page 10-37.

GM recommends replacing worn tires in complete sets of four. Uniform tread depth on all tires will help to maintain the performance of the vehicle.

Braking and handling performance may be adversely affected if all the tires are not replaced at the same time. If proper rotation and maintenance have been done, all four tires should wear out at about the same time. See *Tire Rotation* on page 10-49. However, if it is necessary to replace only one axle set of worn tires, place the new tires on the rear axle.

Winter tires with the same speed rating as the original equipment tires may not be available for H, V, W, Y and ZR speed rated tires. Never exceed the winter tires' maximum speed capability when using winter tires with a lower speed rating.

Warning

Tires could explode during improper service. Attempting to mount or dismount a tire could cause injury or death. Only your dealer or authorized tire service center should mount or dismount the tires.

Warning

Mixing tires of different sizes, brands, or types may cause loss of control of the vehicle, resulting in a crash or other vehicle damage. Use the correct size, brand, and type of tires on all wheels.

Warning

Using bias-ply tires on the vehicle may cause the wheel rim flanges to develop cracks after many miles of driving. A tire and/or wheel could fail suddenly and cause a crash. Use only radial-ply tires with the wheels on the vehicle.

If the vehicle tires must be replaced with a tire that does not have a TPC Spec number, make sure they are the same size, load range, speed rating, and construction (radial) as the original tires.

Vehicles that have a tire pressure monitoring system could give an inaccurate low-pressure warning if non-TPC Spec rated tires are installed. See *Tire Pressure Monitor System* on page 10-44.

The Tire and Loading Information label indicates the original equipment tires on the vehicle. See *Vehicle Load Limits* on page 9-9.

Different Size Tires and Wheels

If wheels or tires are installed that are a different size than the original equipment wheels and tires, vehicle performance, including its braking, ride and handling characteristics, stability, and resistance to rollover may be affected. If the vehicle has electronic systems such as antilock brakes, rollover airbags, traction control, electronic stability control, or All-Wheel Drive, the performance of these systems can also be affected.

 **Warning**

If different sized wheels are used, there may not be an acceptable level of performance and safety if tires not recommended for those wheels are selected. This increases the chance of a crash and serious injury. Only use GM specific wheel and tire systems developed for the vehicle, and have them properly installed by a GM certified technician.

See *Buying New Tires on page 10-51* and *Accessories and Modifications on page 10-2*.

Uniform Tire Quality Grading

Quality grades can be found where applicable on the tire sidewall between tread shoulder and maximum section width. For example:

Treadwear 200 Traction AA Temperature A

The following information relates to the system developed by the United States National Highway Traffic Safety Administration (NHTSA), which grades tires by treadwear, traction, and temperature performance. This applies only to vehicles sold in the United States. The grades are molded on the sidewalls of most passenger car tires. The Uniform Tire Quality Grading (UTQG) system does not apply to deep tread, winter tires, compact spare tires, tires with nominal rim diameters of 10 to 12 inches (25 to 30 cm), or to some limited-production tires.

While the tires available on General Motors passenger cars and light trucks may vary with respect to these grades, they

must also conform to federal safety requirements and additional General Motors Tire Performance Criteria (TPC) standards.

All Passenger Car Tires Must Conform to Federal Safety Requirements In Addition To These Grades.

Treadwear

The treadwear grade is a comparative rating based on the wear rate of the tire when tested under controlled conditions on a specified government test course. For example, a tire graded 150 would wear one and one-half (1½) times as well on the government course as a tire graded 100. The relative performance of tires depends upon the actual conditions of their use, however, and may depart significantly from the norm due to variations in driving

habits, service practices and differences in road characteristics and climate.

Traction

The traction grades, from highest to lowest, are AA, A, B, and C. Those grades represent the tire's ability to stop on wet pavement as measured under controlled conditions on specified government test surfaces of asphalt and concrete. A tire marked C may have poor traction performance. **Warning:** The traction grade assigned to this tire is based on straight-ahead braking traction tests, and does not include acceleration, cornering, hydroplaning, or peak traction characteristics.

Temperature

The temperature grades are A (the highest), B, and C, representing the tire's resistance to the generation of heat and its ability to dissipate heat when tested under controlled conditions on a specified indoor laboratory test wheel. Sustained high temperature can cause the material of the tire to degenerate and reduce tire life, and excessive temperature can lead to sudden tire failure. The grade C corresponds to a level of performance which all passenger car tires must meet under the Federal Motor Safety Standard No. 109. Grades B and A represent higher levels of performance on the laboratory test wheel than the minimum required by law. **Warning:** The temperature grade for this tire is established for a tire that is properly inflated and not

overloaded. Excessive speed, underinflation, or excessive loading, either separately or in combination, can cause heat buildup and possible tire failure.

Wheel Alignment and Tire Balance

The tires and wheels were aligned and balanced at the factory to provide the longest tire life and best overall performance. Adjustments to wheel alignment and tire balancing are not necessary on a regular basis. Consider an alignment check if there is unusual tire wear or the vehicle is significantly pulling to one side or the other. Some slight pull to the left or right, depending on the crown of the road and/or other road surface variations such as troughs or ruts, is normal. If the vehicle is vibrating when driving on a smooth road, the tires and wheels may need to be rebalanced. See your dealer for proper diagnosis.

Wheel Replacement

Replace any wheel that is bent, cracked, or badly rusted or corroded. If wheel nuts keep coming loose, the wheel, wheel bolts, and wheel nuts should be replaced. If the wheel leaks air, replace it. Some aluminum wheels can be repaired. See your dealer if any of these conditions exist.

Your dealer will know the kind of wheel that is needed.

Each new wheel should have the same load-carrying capacity, diameter, width, offset, and be mounted the same way as the one it replaces.

Replace wheels, wheel bolts, wheel nuts, or Tire Pressure Monitor System (TPMS) sensors with new GM original equipment parts.

Warning

Using the wrong replacement wheels, wheel bolts, or wheel nuts can be dangerous. It could affect the braking and handling of the vehicle. Tires can lose air, and cause loss of control, causing a crash. Always use the correct wheel, wheel bolts, and wheel nuts for replacement.

Caution

The wrong wheel can also cause problems with bearing life, brake cooling, speedometer or odometer calibration, headlamp aim, bumper height, vehicle ground clearance, and tire or tire chain clearance to the body and chassis.

Used Replacement Wheels

Warning

Replacing a wheel with a used one is dangerous. How it has been used or how far it has been driven may be unknown. It could fail suddenly and cause a crash. When replacing wheels, use a new GM original equipment wheel.

Tire Chains

Warning

Do not use tire chains. There is not enough clearance. Tire chains used on a vehicle without the proper amount of clearance can cause damage to the brakes, suspension, or other vehicle

(Continued)

Warning (Continued)

parts. The area damaged by the tire chains could cause loss of control and a crash.

Use another type of traction device only if its manufacturer recommends it for the vehicle's tire size combination and road conditions. Follow that manufacturer's instructions. To avoid vehicle damage, drive slow and readjust or remove the traction device if it contacts the vehicle. Do not spin the wheels. If traction devices are used, install them on the front tires.

If a Tire Goes Flat

It is unusual for a tire to blow out while driving, especially if the tires are maintained properly. See *Tires on page 10-35*. If air goes out of a tire, it is much more likely to leak out slowly. But if there ever is a blowout, here are a few tips about what to expect and what to do:

If a front tire fails, the flat tire creates a drag that pulls the vehicle toward that side. Take your foot off the accelerator pedal and grip the steering wheel firmly. Steer to maintain lane position, and then gently brake to a stop, well off the road, if possible.

A rear blowout, particularly on a curve, acts much like a skid and may require the same correction as used in a skid. Stop pressing the accelerator pedal and steer to straighten the vehicle. It may be very bumpy and noisy. Gently brake to a stop, well off the road, if possible.

 **Warning**

Driving on a flat tire will cause permanent damage to the tire. Re-inflating a tire after it has been driven on while severely underinflated or flat may cause a blowout and a serious crash. Never attempt to re-inflate a tire that has been driven on while severely underinflated or flat. Have your dealer or an authorized tire service center repair or replace the flat tire as soon as possible.

 **Warning**

Lifting a vehicle and getting under it to do maintenance or repairs is dangerous without the appropriate safety equipment and training. If a jack is provided with the vehicle, it is designed only for

(Continued)

Warning (Continued)

changing a flat tire. If it is used for anything else, you or others could be badly injured or killed if the vehicle slips off the jack. If a jack is provided with the vehicle, only use it for changing a flat tire.

If a tire goes flat, avoid further tire and wheel damage by driving slowly to a level place, well off the road, if possible. Turn on the hazard warning flashers. See *Hazard Warning Flashers* on page 6-3.

⚠ Warning

Changing a tire can be dangerous. The vehicle can slip off the jack and roll over or fall causing injury or death. Find a level place to change the tire. To help prevent the vehicle from moving:

1. Set the parking brake firmly.
2. Put an automatic transmission in P (Park) or a manual transmission in 1 (First) or R (Reverse).
3. Turn off the engine and do not restart while the vehicle is raised.
4. Do not allow passengers to remain in the vehicle.
5. Place wheel blocks on both sides of the tire at the opposite corner of the tire being changed.

When the vehicle has a flat tire (2), use the following example as a guide to assist in the placement of the wheel blocks (1).

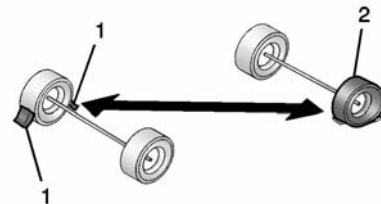

1. Wheel Block
2. Flat Tire

The following information explains how to repair or change a tire.

Tire Changing

Removing Tools

The tools needed to remove the spare tire are located in the storage compartment on the driver side, at the rear of the vehicle.

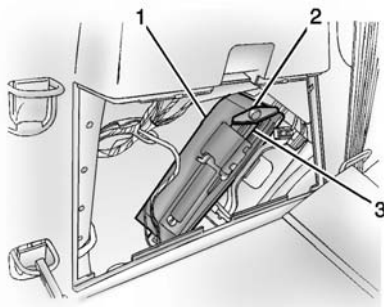

1. Tool Bag
2. Wing Bolt
3. Jack

1. Open the jack storage compartment by pulling on the latch tab, located toward the rear of the vehicle, and pulling the cover off.
2. Remove the wing bolt (2) by turning it counterclockwise.
3. Push the jack (3) up out of the holding bracket and remove the tool bag (1).

4. Turn the jack on its side, with the bottom facing toward you.
5. Pull the jack straight out, bottom first.

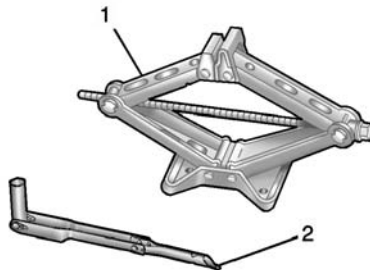

1. Jack
2. Wrench (Three-Piece Shown, One-Piece Similar)

The tools you will be using include the jack (1) and wrench (2).

Removing the Spare Tire

The compact spare tire is located under the vehicle, in front of the rear bumper. See *Compact Spare Tire* on page 10-66 for more information.

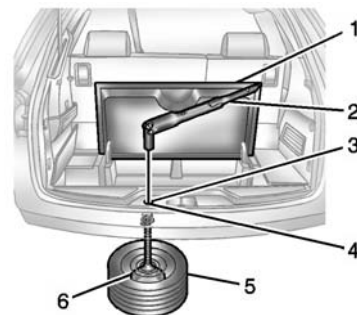

1. Rear Convenience Center
2. Wrench (Three-Piece Shown, One-Piece Similar)
3. Carpet Cutout
4. Hoist Shaft
5. Compact Spare Tire
6. Retainer

1. Open the storage compartment door of the convenience center (1) that is nearest the liftgate.
2. Open the carpet cutout (3) that is located through the hole of the storage compartment.
3. Attach the wrench (2) into the hoist shaft (4).
4. Turn the wrench (2) counterclockwise to lower the spare tire (5) to the ground. Continue turning the wrench until the spare tire can be pulled out from under the vehicle.



5. Tilt the retainer and slip it through the wheel opening to remove the spare tire from the cable.
6. Turn the wrench clockwise to raise the cable back up after removing the spare tire.

Do not store a full-size or a flat road tire under the vehicle. See "Storing the Spare Tire" and "Storing the Flat Tire" later in this section.

Removing the Flat Tire and Installing the Spare Tire

1. Do a safety check before proceeding. See *If a Tire Goes Flat* on page 10-56 for more information.

2. If the vehicle has a wheel cover, loosen the plastic nut caps with the wheel wrench. They will not come off. Then, using the flat end of the wheel wrench, pry along the edge of the cover until it comes off. Be careful; the edges may be sharp. Do not try to remove the cover with your bare hands.

Store the wheel cover securely in the rear of the vehicle until you have the flat tire repaired or replaced.

If the vehicle has aluminum wheels, remove the wheel nut caps using the wheel wrench.

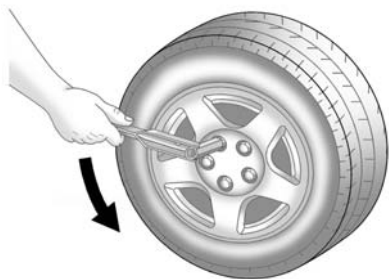

3. Loosen the wheel nuts — but do not remove them — using the wrench. For wheels with a wheel lock key, use the wheel lock key between the lock nut and wrench. The key is supplied in the front passenger door pocket.

⚠ Caution

If this vehicle has wheel locks and an impact wrench is used to remove the wheel nuts, the lock nut or wheel lock key could be

(Continued)

Caution (Continued)

damaged. Do not use an impact wrench to remove the wheel nuts if this vehicle has wheel locks.

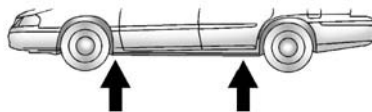

4. To identify the appropriate jacking location, find the triangle or rectangular notch about 30.5 cm (12 in) from the front tire or about 27 cm (10.5 in) from the rear tire.

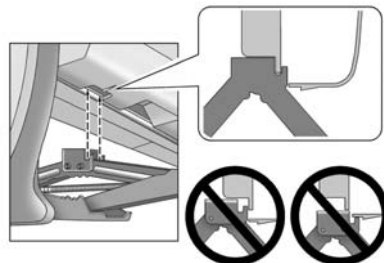

Triangle Shown, Without Similar

The triangle may be located near each wheel on the vehicle's exterior.

⚠ Caution

If a jack is used to raise the vehicle without positioning it correctly, the vehicle could be damaged. When raising the vehicle on a jack, avoid contact with the rear axle control arms.

5. Attach the wrench to the jack, and turn the wrench clockwise to raise the jack head 7.6 cm (3 in).
6. Do not raise the vehicle yet. Put the compact spare tire near you.

⚠ Warning

Getting under a vehicle when it is lifted on a jack is dangerous. If the vehicle slips off the jack, you could be badly injured or killed. Never get under a vehicle when it is supported only by a jack.

⚠ Warning

Raising the vehicle with the jack improperly positioned can damage the vehicle and even make the vehicle fall. To help avoid personal injury and vehicle

(Continued)

Warning (Continued)

damage, be sure to fit the jack lift head into the proper location before raising the vehicle.

7. Raise the vehicle by turning the wrench clockwise in the jack. Raise the vehicle far enough off the ground so that there is enough room for the spare tire to fit under the wheel well.
8. Remove all the wheel nuts and the flat tire.

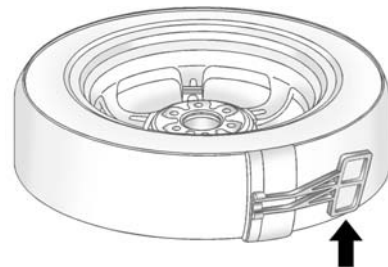

9. Remove the plastic spare tire heat shield by pulling the rubber latch. Store the plastic spare tire heat shield. See “Storing the Spare Tire” later in this section for more information.

⚠ Warning

Rust or dirt on a wheel, or on the parts to which it is fastened, can make wheel nuts become loose after time. The wheel could come off and cause an accident. When

(Continued)

Warning (Continued)

changing a wheel, remove any rust or dirt from places where the wheel attaches to the vehicle. In an emergency, a cloth or a paper towel can be used; however, use a scraper or wire brush later to remove all rust or dirt.

Warning

Never use oil or grease on bolts or nuts because the nuts might come loose. The vehicle's wheel could fall off, causing a crash.

10. Remove any rust or dirt from the wheel bolts, mounting surfaces, and spare wheel.
11. Place the spare tire on the wheel mounting surface.
12. Put the nuts on by hand by turning them clockwise until the wheel is held against the

mounting surface. Make sure the rounded end is toward the wheel.

13. Lower the vehicle by attaching the wrench to the jack and turning the wrench counterclockwise. Lower the jack completely.

Warning

Wheel nuts that are improperly or incorrectly tightened can cause the wheels to become loose or come off. The wheel nuts should be tightened with a torque wrench to the proper torque specification after replacing. Follow the torque specification supplied by the aftermarket manufacturer when using accessory locking wheel nuts. See *Capacities and Specifications* on page 12-2 for original equipment wheel nut torque specifications.

Caution

Improperly tightened wheel nuts can lead to brake pulsation and rotor damage. To avoid expensive brake repairs, evenly tighten the wheel nuts in the proper sequence and to the proper torque specification. See *Capacities and Specifications* for the wheel nut torque specification.

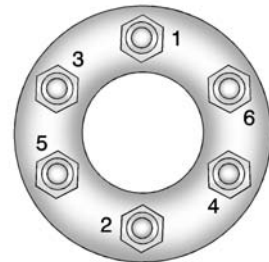

- Tighten the wheel nuts firmly in a crisscross sequence, as shown.

 **Caution**

Wheel covers will not fit on the vehicle's compact spare. If you try to put a wheel cover on the compact spare, the cover or the spare could be damaged.

Storing the Spare Tire

 **Warning**

The underbody-mounted spare tire needs to be stored with the valve stem pointing down. If the spare tire is stored with the valve stem pointing upwards, the secondary latch will not work properly and the spare tire could loosen and suddenly fall from the vehicle. If this happened when

(Continued)

Warning (Continued)

the vehicle was being driven, the tire might contact a person or another vehicle, causing injury and damage to itself. Be sure the underbody-mounted spare tire is stored with the valve stem pointing down.

 **Warning**

Storing a jack, a tire, or other equipment in the passenger compartment of the vehicle could cause injury. In a sudden stop or collision, loose equipment could strike someone. Store all these in the proper place.

To store the spare tire:

- Lay the compact spare tire near the rear of the vehicle with the valve stem down.

- Reinstall the plastic spare tire heat shield on the compact spare tire.
- Slide the cable retainer through the center of the wheel and start to raise the compact spare tire. Make sure the retainer is fully seated across the underside of the wheel.
- When the compact spare tire is almost in the stored position, turn the tire so the valve is toward the rear of the vehicle. This position helps when checking the air pressure in the compact spare tire.
- Raise the tire fully against the underside of the vehicle. Continue turning the wrench until you feel more than two clicks. This indicates that the compact spare tire is secure and the cable is tight. The spare tire hoist cannot be overtightened.

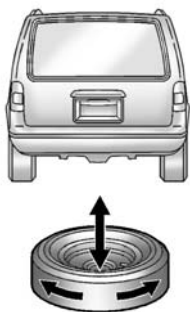

6. Make sure the tire is stored securely. Push, pull, and then try to turn the tire. If the tire moves, use the wrench to tighten the cable.

Storing the Flat Tire

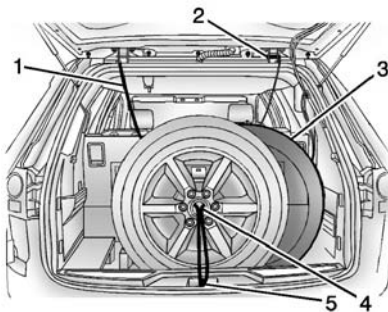

1. Cable
 2. Liftgate Hinges
 3. Spare Tire Heat Shield
 4. Center of the Wheel
 5. Door Striker
1. Remove the cable package from the jack storage area.
 2. Remove the small center cap by tapping the back of the cap with the extension of the shaft, if the vehicle has aluminum wheels.

3. Put the flat tire in the rear storage area with the valve stem pointing toward the rear of the vehicle.
4. Pull the cable (1) through the door striker (5), the center of the wheel (4), and the plastic spare tire heat shield (3), as shown.

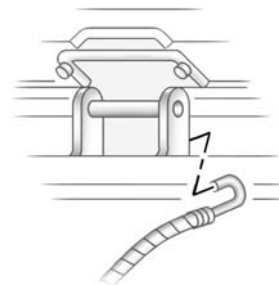

5. Hook the cable onto the outside portion of the liftgate hinges (2).
6. Hook the other end of the cable onto the outside portion of the liftgate hinge on the other side of the vehicle.

- Pull on the cable to make sure it is secure.

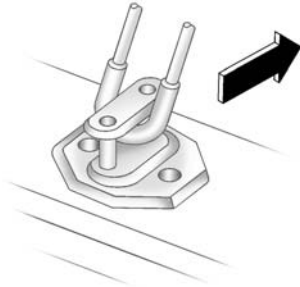

- Make sure the metal tube is centered at the striker. Push the tube toward the front of the vehicle.
- Close the liftgate and make sure it is latched properly.

Storing the Tools

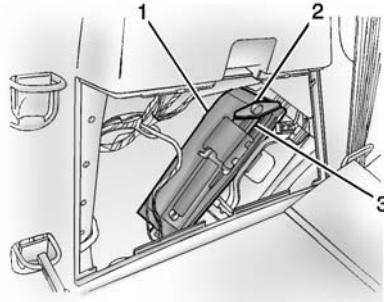

- Tool Bag
- Wing Bolt
- Jack

Put back all tools as they were stored in the jack storage compartment and put the compartment cover back on.

- Ensure that the bottom of the jack is facing toward you.
- Replace the tool bag (1).

- Turn the jack (3) on its side and place down on the holding bracket.
- Reinstall the wing bolt (2) by turning clockwise.
- To replace the cover, line up the tab at the front of the cover with the notch in the cover opening. Push the cover in place and make sure that the rear clips are in the slots and push the cover closed.

Store the center cap or the plastic bolt-on wheel covers until a full size tire is put back on the vehicle. When you replace the compact spare with a full-size tire, reinstall the bolt-on wheel covers or the center cap. Hand-tighten them over the wheel nuts, using the wrench.

Compact Spare Tire

Warning

Driving with more than one compact spare tire at a time could result in loss of braking and handling. This could lead to a crash and you or others could be injured. Use only one compact spare tire at a time.

If this vehicle has a compact spare tire, it was fully inflated when new; however, it can lose air over time. Check the inflation pressure regularly. It should be 420 kPa (60 psi).

Stop as soon as possible and check that the spare tire is correctly inflated after being installed on the vehicle. The compact spare tire is designed for temporary use only. The vehicle will perform differently with the spare tire installed and it is recommended that the vehicle speed be limited to 80 km/h

(50 mph). To conserve the tread of the spare tire, have the standard tire repaired or replaced as soon as convenient and return the spare tire to the storage area.

When using a compact spare tire, the ABS and Traction Control systems may engage until the spare tire is recognized by the vehicle, especially on slippery roads. Adjust driving to reduce possible wheel slip.

Performance of the All-Wheel Drive (AWD) system will be automatically reduced to protect the system when using the compact spare. To restore the AWD and prevent excessive wear on the clutch in the AWD, replace the compact spare tire with a full-size tire as soon as possible.

Caution

When the compact spare is installed, do not take the vehicle through an automatic car wash with guide rails. The compact spare can get caught on the rails which can damage the tire, wheel, and other parts of the vehicle.

Do not use the compact spare on other vehicles.

Do not mix the compact spare tire or wheel with other wheels or tires. They will not fit. Keep the spare tire and its wheel together.

Caution

Tire chains will not fit the compact spare. Using them can damage the vehicle and the chains. Do not use tire chains on the compact spare.

Jump Starting

For more information about the vehicle battery, see *Battery* on page 10-23.

If the vehicle battery has run down, you may want to use another vehicle and some jumper cables to start your vehicle. Be sure to use the following steps to do it safely.

Warning

Batteries can hurt you. They can be dangerous because:

- They contain acid that can burn you.
- They contain gas that can explode or ignite.
- They contain enough electricity to burn you.

If you do not follow these steps exactly, some or all of these things can hurt you.

Caution

Ignoring these steps could result in costly damage to the vehicle that would not be covered by the vehicle warranty. Trying to start the vehicle by pushing or pulling it will not work, and it could damage the vehicle.

1. Check the other vehicle. It must have a 12-volt battery with a negative ground system.

Caution

If the other vehicle does not have a 12-volt system with a negative ground, both vehicles can be damaged. Only use a vehicle that has a 12-volt system with a negative ground for jump starting.

2. Get the vehicles close enough so the jumper cables can reach, but be sure the vehicles are not touching each other. If they are, it could cause a ground connection you do not want. You would not be able to start your vehicle, and the bad grounding could damage the electrical systems.

To avoid the possibility of the vehicles rolling, set the parking brake firmly on both vehicles involved in the jump start procedure. Put an automatic transmission in P (Park) or a manual transmission in Neutral before setting the parking brake. If one of the vehicles is a four-wheel-drive vehicle, be sure the transfer case is not in Neutral.

 **Caution**

If any accessories are left on or plugged in during the jump starting procedure, they could be damaged. The repairs would not be covered by the vehicle warranty. Whenever possible, turn off or unplug all accessories on either vehicle when jump starting.

3. Turn off the ignition on both vehicles. Unplug unnecessary accessories plugged into the cigarette lighter or the accessory power outlets. Turn off the radio and all lamps that are not needed. This will avoid sparks and help save both batteries. And it could save the radio!

4. Open the hoods and locate the positive (+) and negative (-) terminal locations on the other vehicle. Your vehicle has a remote positive (+) and a remote negative (-) jump starting terminal. See *Engine Compartment Overview on page 10-5* for the terminal locations.

 **Warning**

Using a match near a battery can cause battery gas to explode. People have been hurt doing this, and some have been blinded. Use a flashlight if you need more light.

Be sure the batteries have enough water. You do not need to add water to the ACDelco[®] battery (or batteries) installed in your new vehicle. But if a battery has filler caps, be sure the right amount of fluid is there. If it is low,

(Continued)

Warning (Continued)

add water to take care of that first. If you do not, explosive gas could be present.

Battery fluid contains acid that can burn you. Do not get it on you. If you accidentally get it in your eyes or on your skin, flush the place with water and get medical help immediately.

 **Warning**

Fans or other moving engine parts can injure you badly. Keep your hands away from moving parts once the engine is running.

5. Check that the jumper cables do not have loose or missing insulation. If they do, you could get a shock. The vehicles could be damaged too.

Before you connect the cables, here are some basic things you should know. Positive (+) will go to positive (+) or to a remote positive (+) terminal if the vehicle has one. Negative (-) will go to a heavy, unpainted metal engine part or to a remote negative (-) terminal if the vehicle has one.

Do not connect positive (+) to negative (-) or you will get a short that would damage the battery and maybe other parts too. And do not connect the negative (-) cable to the negative (-) terminal on the dead battery because this can cause sparks.

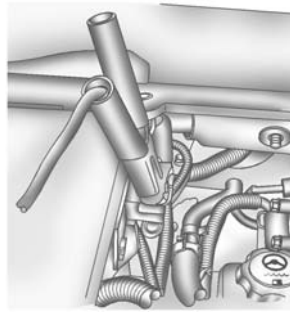

6. Connect the red positive (+) cable to the positive (+) terminal of the dead battery. Use a remote positive (+) terminal if the vehicle has one.
7. Do not let the other end touch metal. Connect it to the positive (+) terminal of the good battery. Use a remote positive (+) terminal if the vehicle has one.

8. Now connect the black negative (-) cable to the negative (-) terminal of the good battery. Use a remote negative (-) terminal if the vehicle has one.

Do not let the other end touch anything until the next step. The other end of the negative (-) cable does not go to the dead battery. It goes to a heavy, unpainted metal engine part, or to a remote negative (-) terminal on the vehicle with the dead battery.

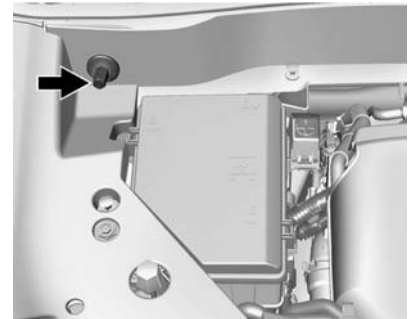

9. Connect the other end of the negative (-) cable to the remote negative (-) terminal of the dead battery.

Your vehicle has a remote negative (-) terminal for this purpose.

10. Now start the vehicle with the good battery and run the engine for a while.
11. Try to start the vehicle that had the dead battery. If it will not start after a few tries, it probably needs service.

Caution

If the jumper cables are connected or removed in the wrong order, electrical shorting may occur and damage the vehicle. The repairs would not be covered by the vehicle warranty. Always connect and remove the jumper cables in the correct order, making sure that the cables do not touch each other or other metal.

Jumper Cable Removal

Reverse the sequence exactly when removing the jumper cables.

Towing the Vehicle

Caution

Incorrectly towing a disabled vehicle may cause damage. The damage would not be covered by the vehicle warranty.

Have the vehicle towed on a flatbed car carrier or a wheel lift tow truck. If a wheel lift tow truck is used, the drive wheels cannot contact the road while the vehicle is being towed. A wheel dolly must be used to lift all drive wheels off the ground.

Consult your dealer or a professional towing service if the disabled vehicle must be towed.

Recreational Vehicle Towing

Recreational vehicle towing means towing the vehicle behind another vehicle – such as behind a motor home. The two most common types of recreational vehicle towing are known as dinghy towing and dolly towing. Dinghy towing is towing the vehicle with all four wheels on the ground. Dolly towing is towing the vehicle with two wheels on the ground and two wheels up on a device known as a dolly.

Here are some important things to consider before recreational vehicle towing:

- The towing capacity of the towing vehicle. Be sure to read the tow vehicle manufacturer's recommendations.
- How far the vehicle will be towed. Some vehicles have restrictions on how far and how long they can be towed.

- The proper towing equipment. See your dealer or trailering professional for additional advice and equipment recommendations.
- If the vehicle is ready to be towed. Just as preparing the vehicle for a long trip, make sure the vehicle is prepared to be towed.

Dinghy Towing

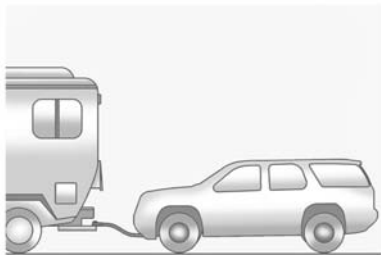

If the vehicle is front-wheel-drive, it can be dinghy towed from the front. These vehicles may also be towed

by putting the front wheels on a dolly. See “Dolly Towing” later in this section.

If the vehicle is all-wheel-drive, it can be dinghy towed from the front. These vehicles can also be towed by placing them on a platform trailer with all four wheels off of the ground. These vehicles cannot be towed using a dolly.

For vehicles being dinghy towed, the vehicle should be run at the beginning of each day and at each RV fuel stop for about five minutes. This will ensure proper lubrication of transmission components. Reinstall the fuse to start the vehicle.

To tow the vehicle from the front with all four wheels on the ground:

1. Position the vehicle to be towed, shift the transmission to P (Park), and turn the ignition to LOCK/OFF.
2. Secure the vehicle to the towing vehicle.
3. Set the parking brake.

10-72 Vehicle Care

- Turn the ignition to ACC/ACCESSORY.
- Shift the transmission to N (Neutral).
- To prevent the battery from draining while the vehicle is being towed, remove the 15 amp ECM fuse and the 15 amp Onstar fuse. These are in the battery compartment behind the passenger seat on the floor. Also, remove the 50 amp BATT1 fuse from the underhood fuse block and store all fuses in a safe location. See *Engine Compartment Fuse Block on page 10-29*.
- Release the parking brake.

Caution

If the vehicle is towed without performing each of the steps listed under “Dinghy Towing,” the automatic transmission could be

(Continued)

Caution (Continued)

damaged. Be sure to follow all steps of the dinghy towing procedure prior to and after towing the vehicle.

Caution

If 105 km/h (65 mph) is exceeded while towing the vehicle, it could be damaged. Never exceed 105 km/h (65 mph) while towing the vehicle.

Once the destination is reached:

- Set the parking brake.
- Reinstall the fuses.
- Shift the transmission to P (Park), turn the ignition to LOCK/OFF and remove the key from the ignition.
- Disconnect the vehicle from the towing vehicle.

Caution

Do not tow a vehicle with the front drive wheels on the ground if one of the front tires is a compact spare tire. Towing with two different tire sizes on the front of the vehicle can cause severe damage to the transmission.

Dolly Towing (All-Wheel-Drive Vehicles)

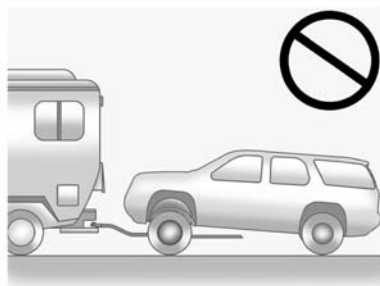

All-wheel-drive vehicles must not be towed with two wheels on the ground. To properly tow these vehicles, they should be placed on a platform trailer with all four wheels off of the ground or dinghy towed from the front.

Dolly Towing (Front-Wheel-Drive Vehicles Only)



To tow a front-wheel-drive vehicle from the front with two wheels on the ground:

1. Put the front wheels on a dolly.

2. Move the shift lever to P (Park).
3. Set the parking brake.
4. Clamp the steering wheel in a straight-ahead position with a clamping device designed for towing.
5. Remove the key from the ignition.
6. Secure the vehicle to the dolly.
7. Release the parking brake.

Towing the Vehicle From the Rear

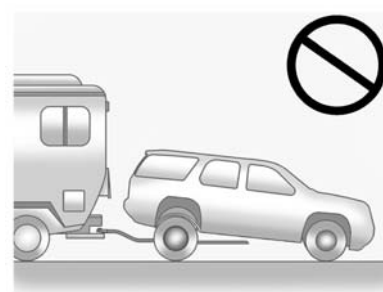
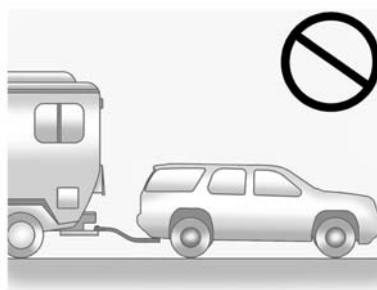

Caution

Towing the vehicle from the rear could damage it. Also, repairs would not be covered by the vehicle warranty. Never have the vehicle towed from the rear.

Do not tow the vehicle from the rear.

Appearance Care

Exterior Care

Locks

Locks are lubricated at the factory. Use a de-icing agent only when absolutely necessary, and have the locks greased after using. See *Recommended Fluids and Lubricants* on page 11-12.

Washing the Vehicle

To preserve the vehicle's finish, wash it often and out of direct sunlight.

Caution

Do not use petroleum-based, acidic, or abrasive cleaning agents as they can damage the vehicle's paint, metal, or plastic parts. If damage occurs, it would not be covered by the vehicle warranty. Approved cleaning

(Continued)

Caution (Continued)

products can be obtained from your dealer. Follow all manufacturer directions regarding correct product usage, necessary safety precautions, and appropriate disposal of any vehicle care product.

Caution

Avoid using high-pressure washes closer than 30 cm (12 in) to the surface of the vehicle. Use of power washers exceeding 8,274 kPa (1,200 psi) can result in damage or removal of paint and decals.

The  symbol is on any underhood compartment electrical center that should not be power

washed. This could cause damage that would not be covered by the vehicle warranty.

If using an automatic car wash, follow the car wash instructions. The windshield wiper and rear window wiper, if equipped, must be off. Remove any accessories that may be damaged or interfere with the car wash equipment.

Rinse the vehicle well, before washing and after, to remove all cleaning agents completely. If they are allowed to dry on the surface, they could stain.

Dry the finish with a soft, clean chamois or an all-cotton towel to avoid surface scratches and water spotting.

Finish Care

Application of aftermarket clearcoat sealant/wax materials is not recommended. If painted surfaces are damaged, see your dealer to have the damage assessed and repaired. Foreign materials such as

calcium chloride and other salts, ice melting agents, road oil and tar, tree sap, bird droppings, chemicals from industrial chimneys, etc., can damage the vehicle's finish if they remain on painted surfaces. Wash the vehicle as soon as possible. If necessary, use non-abrasive cleaners that are marked safe for painted surfaces to remove foreign matter.

Occasional hand waxing or mild polishing should be done to remove residue from the paint finish. See your dealer for approved cleaning products.

Do not apply waxes or polishes to uncoated plastic, vinyl, rubber, decals, simulated wood, or flat paint as damage can occur.

 Caution
Machine compounding or aggressive polishing on a basecoat/clearcoat paint finish (Continued)

Caution (Continued)
may damage it. Use only non-abrasive waxes and polishes that are made for a basecoat/clearcoat paint finish on the vehicle.

To keep the paint finish looking new, keep the vehicle garaged or covered whenever possible.

Protecting Exterior Bright Metal Moldings

 Caution
Failure to clean and protect the bright metal moldings can result in a hazy white finish or pitting. This damage would not be covered by the vehicle warranty.

The bright metal moldings on the vehicle are aluminum or stainless steel. To prevent damage always follow these cleaning instructions:

- Be sure the molding is cool to the touch before applying any cleaning solution.
- Use a cleaning solution approved for aluminum or stainless steel. Some cleaners are highly acidic or contain alkaline substances and can damage the moldings.
- Always dilute a concentrated cleaner according to the manufacturer's instructions.
- Do not use chrome cleaners.
- Do not use cleaners that are not intended for automotive use.
- Use a nonabrasive wax on the vehicle after washing to protect and extend the molding finish.

Cleaning Exterior Lamps/ Lenses, Emblems, Decals and Stripes

Use only lukewarm or cold water, a soft cloth, and a car washing soap to clean exterior lamps, lenses, emblems, decals and stripes. Follow instructions under "Washing the Vehicle" previously in this section.

Lamp covers are made of plastic, and some have a UV protective coating. Do not clean or wipe them when dry.

Do not use any of the following on lamp covers:

- Abrasive or caustic agents.
- Washer fluids and other cleaning agents in higher concentrations than suggested by the manufacturer.
- Solvents, alcohols, fuels, or other harsh cleaners.
- Ice scrapers or other hard items.

- Aftermarket appearance caps or covers while the lamps are illuminated, due to excessive heat generated.

 **Caution**

Failure to clean lamps properly can cause damage to the lamp cover that would not be covered by the vehicle warranty.

 **Caution**

Using wax on low gloss black finish stripes can increase the gloss level and create a non-uniform finish. Clean low gloss stripes with soap and water only.

Air Intakes

Clear debris from the air intakes, between the hood and windshield when washing the vehicle.

Windshield and Wiper Blades

Clean the outside of the windshield with glass cleaner.

Clean rubber blades using a lint-free cloth or paper towel soaked with windshield washer fluid or a mild detergent. Wash the windshield thoroughly when cleaning the blades. Bugs, road grime, sap, and a buildup of vehicle wash/wax treatments may cause wiper streaking.

Replace the wiper blades if they are worn or damaged. Damage can be caused by extreme dusty conditions, sand, salt, heat, sun, snow, and ice.

Weatherstrips

Apply Dielectric silicone grease on weatherstrips to make them last longer, seal better, and not stick or squeak. Lubricate weatherstrips at least once a year. Hot, dry climates may require more frequent application. Black marks from rubber material on painted surfaces can be removed by rubbing with a clean cloth. See *Recommended Fluids and Lubricants* on page 11-12.

Tires

Use a stiff brush with tire cleaner to clean the tires.

Caution

Using petroleum-based tire dressing products on the vehicle may damage the paint finish and/or tires. When applying a tire dressing, always wipe off any overspray from all painted surfaces on the vehicle.

Wheels and Trim — Aluminum or Chrome

Use a soft, clean cloth with mild soap and water to clean the wheels. After rinsing thoroughly with clean water, dry with a soft, clean towel. A wax may then be applied.

Caution

Chrome wheels and other chrome trim may be damaged if the vehicle is not washed after driving on roads that have been sprayed with magnesium, calcium, or sodium chloride. These chlorides are used on roads for conditions such as ice and dust. Always wash the chrome with soap and water after exposure.

Caution

To avoid surface damage, do not use strong soaps, chemicals, abrasive polishes, cleaners, brushes, or cleaners that contain acid on aluminum or chrome-plated wheels. Use only approved cleaners. Also, never drive a vehicle with aluminum or chrome-plated wheels through an automatic car wash that uses silicone carbide tire cleaning brushes. Damage could occur and the repairs would not be covered by the vehicle warranty.

Steering, Suspension, and Chassis Components

Visually inspect steering, suspension, and chassis components for damaged, loose, or missing parts or signs of wear at least once a year.

Inspect power steering for proper hook-up, binding, leaks, cracks, chafing, etc.

Visually check constant velocity joint boots and axle seals for leaks.

Body Component Lubrication

Lubricate all key lock cylinders, hood hinges, liftgate hinges, steel fuel door hinge, unless the components are plastic. Applying silicone grease on weatherstrips with a clean cloth will make them last longer, seal better, and not stick or squeak.

Underbody Maintenance

At least twice a year, spring and fall use plain water to flush any corrosive materials from the underbody. Take care to thoroughly clean any areas where mud and other debris can collect.

Sheet Metal Damage

If the vehicle is damaged and requires sheet metal repair or replacement, make sure the body

repair shop applies anti-corrosion material to parts repaired or replaced to restore corrosion protection.

Original manufacturer replacement parts will provide the corrosion protection while maintaining the vehicle warranty.

Finish Damage

Quickly repair minor chips and scratches with touch-up materials available from your dealer to avoid corrosion. Larger areas of finish damage can be corrected in your dealer's body and paint shop.

Chemical Paint Spotting

Airborne pollutants can fall upon and attack painted vehicle surfaces causing blotchy, ring-shaped discolorations, and small, irregular dark spots etched into the paint surface. See "Finish Care" previously in this section.

Interior Care

To prevent dirt particle abrasions, regularly clean the vehicle's interior. Immediately remove any soils. Note that newspapers or dark garments that can transfer color to home furnishings can also permanently transfer color to the vehicle's interior.

Use a soft bristle brush to remove dust from knobs and crevices on the instrument cluster. Using a mild soap solution, immediately remove hand lotions, sunscreen, and insect repellent from all interior surfaces or permanent damage may result.

Your dealer may have products for cleaning the interior. Use cleaners specifically designed for the surfaces being cleaned to prevent permanent damage. Apply all cleaners directly to the cleaning cloth. Do not spray cleaners directly on any switches or controls. Cleaners should be removed quickly. Never allow cleaners to

remain on the surface being cleaned for extended periods of time.

Cleaners may contain solvents that can become concentrated in the interior. Before using cleaners, read and adhere to all safety instructions on the label. While cleaning the interior, maintain adequate ventilation by opening the doors and windows.

To prevent damage, do not clean the interior using the following cleaners or techniques:

- Never use a razor or any other sharp object to remove a soil from any interior surface.
- Never use a brush with stiff bristles.
- Never rub any surface aggressively or with excessive pressure.

- Do not use laundry detergents or dishwashing soaps with degreasers. For liquid cleaners, use approximately 20 drops per 3.8 L (1 gal) of water. A concentrated soap solution will leave a residue that creates streaks and attracts dirt. Do not use solutions that contain strong or caustic soap.
- Do not heavily saturate the upholstery when cleaning.
- Do not use solvents or cleaners containing solvents.

Interior Glass

To clean, use a terry cloth fabric dampened with water. Wipe droplets left behind with a clean dry cloth. Commercial glass cleaners may be used, if necessary, after cleaning the interior glass with plain water.

Caution

To prevent scratching, never use abrasive cleaners on automotive glass. Abrasive cleaners or aggressive cleaning may damage the rear window defogger.

Cleaning the windshield with water during the first three to six months of ownership will reduce tendency to fog.

Speaker Covers

Vacuum around a speaker cover gently, so that the speaker will not be damaged. Clean spots with just water and mild soap.

Coated Moldings

Coated moldings should be cleaned.

- When lightly soiled, wipe with a sponge or soft lint-free cloth dampened with water.
- When heavily soiled, use warm soapy water.

Fabric/Carpet/Suede

Start by vacuuming the surface using a soft brush attachment. If a rotating brush attachment is being used during vacuuming, only use it on the floor carpet. Before cleaning, gently remove as much of the soil as possible using one of the following techniques:

- Gently blot liquids with a paper towel. Continue blotting until no more soil can be removed.
- For solid soils, remove as much as possible prior to vacuuming.

To clean:

1. Saturate a clean lint-free colorfast cloth with water. Microfiber cloth is recommended to prevent lint transfer to the fabric or carpet.
2. Remove excess moisture by gently wringing until water does not drip from the cleaning cloth.

3. Start on the outside edge of the soil and gently rub toward the center. Fold the cleaning cloth to a clean area frequently to prevent forcing the soil in to the fabric.
4. Continue gently rubbing the soiled area until there is no longer any color transfer from the soil to the cleaning cloth.
5. If the soil is not completely removed, use a mild soap solution followed only by plain water.

If the soil is not completely removed, it may be necessary to use a commercial upholstery cleaner or spot lifter. Test a small hidden area for colorfastness before using a commercial upholstery cleaner or spot lifter. If ring formation occurs, clean the entire fabric or carpet.

Following the cleaning process, a paper towel can be used to blot excess moisture.

Cleaning High Gloss Surfaces and Vehicle Information and Radio Displays

For vehicles with high gloss surfaces or vehicle displays, use a microfiber cloth to wipe surfaces. Before wiping the surface with the microfiber cloth, use a soft bristle brush to remove dirt that could scratch the surface. Then use the microfiber cloth by gently rubbing to clean. Never use window cleaners or solvents. Periodically hand wash the microfiber cloth separately, using mild soap. Do not use bleach or fabric softener. Rinse thoroughly and air dry before next use.

 Caution
Do not attach a device with a suction cup to the display. This may cause damage and would not be covered by the warranty.

Instrument Panel, Leather, Vinyl, Other Plastic Surfaces, Low Gloss Paint Surfaces and Natural Open Pore Wood Surfaces

Use a soft microfiber cloth dampened with water to remove dust and loose dirt. For a more thorough cleaning, use a soft microfiber cloth dampened with a mild soap solution.

 **Caution**

Soaking or saturating leather, especially perforated leather, as well as other interior surfaces, may cause permanent damage. Wipe excess moisture from these surfaces after cleaning and allow them to dry naturally. Never use heat, steam, spot lifters, or spot removers. Do not use cleaners that contain silicone or wax-based products. Cleaners containing

(Continued)

Caution (Continued)

these solvents can permanently change the appearance and feel of leather or soft trim and are not recommended.

Do not use cleaners that increase gloss, especially on the instrument panel. Reflected glare can decrease visibility through the windshield under certain conditions.

 **Caution**

Use of air fresheners may cause permanent damage to plastics and painted surfaces. If an air freshener comes in contact with any plastic or painted surface in the vehicle, blot immediately and clean with a soft cloth dampened with a mild soap solution. Damage caused by air fresheners would not be covered by the vehicle warranty.

Cargo Cover and Convenience Net

Wash with warm water and mild detergent. Do not use chlorine bleach. Rinse with cold water, and then dry completely.

Care of Safety Belts

Keep belts clean and dry.

 **Warning**

Do not bleach or dye safety belts. It may severely weaken them. In a crash, they might not be able to provide adequate protection. Clean safety belts only with mild soap and lukewarm water.

Floor Mats

Warning

If a floor mat is the wrong size or is not properly installed, it can interfere with the pedals. Interference with the pedals can cause unintended acceleration and/or increased stopping distance which can cause a crash and injury. Make sure the floor mat does not interfere with the pedals.

Use the following guidelines for proper floor mat usage.

- The original equipment floor mats were designed for your vehicle. If the floor mats need replacing, it is recommended that GM certified floor mats be purchased. Non-GM floor mats may not fit properly and may interfere with the accelerator or

brake pedal. Always check that the floor mats do not interfere with the pedals.

- Use the floor mat with the correct side up. Do not turn it over.
- Do not place anything on top of the driver side floor mat.
- Use only a single floor mat on the driver side.
- Do not place one floor mat on top of another.

Button Retainer

Some vehicles have floor mats with a button-type retainer.

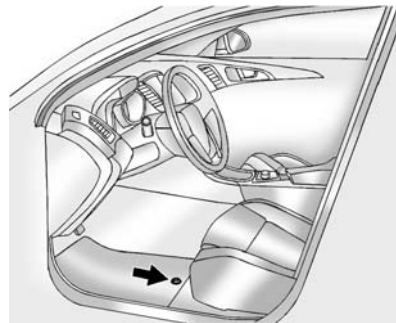

Removing and Replacing the Floor Mat

1. Pull up on the rear of the mat to unlock and remove.
2. Reinstall the floor mat by lining up the floor mat openings over the carpet retainers and snapping into position.
3. Make sure the floor mat is properly secured and verify that it does not interfere with the pedals.

Knob Retainer

Some vehicles have floor mats with a knob retainer.

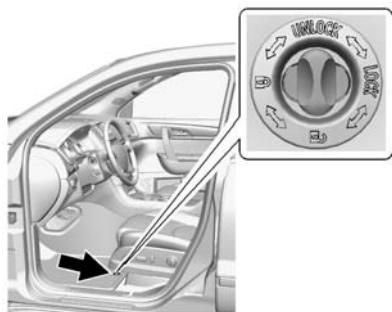

Removing and Replacing the Floor Mat

1. Turn the knob until it is aligned with the slot in the floor mat grommet.

2. Pull up on the floor mat.
3. Center the slot in the floor mat grommet with the knob on the floor and set into position.
4. Turn the knob until it is perpendicular to the slot in the grommet to lock the mat in place.
5. Make sure the floor mat is properly secured and verify that it does not interfere with the pedals.

Service and Maintenance

General Information

General Information 11-1

Maintenance Schedule

Maintenance Schedule 11-2

Special Application Services

Special Application
Services 11-8

Additional Maintenance and Care

Additional Maintenance
and Care 11-8

Recommended Fluids, Lubricants, and Parts

Recommended Fluids and
Lubricants 11-12
Maintenance Replacement
Parts 11-13

Maintenance Records

Maintenance Records 11-14

General Information

Your vehicle is an important investment. This section describes the required maintenance for the vehicle. Follow this schedule to help protect against major repair expenses resulting from neglect or inadequate maintenance. It may also help to maintain the value of the vehicle if it is sold. It is the responsibility of the owner to have all required maintenance performed.

Your dealer has trained technicians who can perform required maintenance using genuine replacement parts. They have up-to-date tools and equipment for fast and accurate diagnostics. Many dealers have extended evening and Saturday hours, courtesy transportation, and online scheduling to assist with service needs.

Your dealer recognizes the importance of providing competitively priced maintenance and repair services. With trained

technicians, the dealer is the place for routine maintenance such as oil changes and tire rotations and additional maintenance items like tires, brakes, batteries, and wiper blades.

Caution

Damage caused by improper maintenance can lead to costly repairs and may not be covered by the vehicle warranty.

Maintenance intervals, checks, inspections, recommended fluids, and lubricants are important to keep the vehicle in good working condition.

The Tire Rotation and Required Services are the responsibility of the vehicle owner. It is recommended to have your dealer perform these services every 12 000 km/7,500 mi. Proper vehicle maintenance helps to keep the vehicle in good working condition, improves fuel economy, and reduces vehicle emissions.

11-2 Service and Maintenance

Because of the way people use vehicles, maintenance needs vary. There may need to be more frequent checks and services. The Additional Required Services - Normal are for vehicles that:

- Carry passengers and cargo within recommended limits on the Tire and Loading Information label. See *Vehicle Load Limits on page 9-9*.
- Are driven on reasonable road surfaces within legal driving limits.
- Use the recommended fuel. See *Fuel on page 9-42*.

Refer to the information in the Maintenance Schedule Additional Required Services - Normal chart.

The Additional Required Services - Severe are for vehicles that are:

- Mainly driven in heavy city traffic in hot weather.
- Mainly driven in hilly or mountainous terrain.

- Frequently towing a trailer.
- Used for high speed or competitive driving.
- Used for taxi, police, or delivery service.

Refer to the information in the Maintenance Schedule Additional Required Services - Severe chart.

Warning

Performing maintenance work can be dangerous and can cause serious injury. Perform maintenance work only if the required information, proper tools, and equipment are available. If they are not, see your dealer to have a trained technician do the work. See *Doing Your Own Service Work on page 10-3*.

Maintenance Schedule

Owner Checks and Services

At Each Fuel Stop

- Check the engine oil level. See *Engine Oil on page 10-7*.

Once a Month

- Check the tire inflation pressures. See *Tire Pressure on page 10-43*.
- Inspect the tires for wear. See *Tire Inspection on page 10-48*.
- Check the windshield washer fluid level. See *Washer Fluid on page 10-19*.

Engine Oil Change

When the CHANGE ENGINE OIL SOON message displays, have the engine oil and filter changed within the next 1 000 km/600 mi. If driven under the best conditions, the engine oil life system may not indicate the need for vehicle service for up to a year.

The engine oil and filter must be changed at least once a year and the oil life system must be reset. Your trained dealer technician can perform this work. If the engine oil life system is reset accidentally, service the vehicle within 5 000 km/3,000 mi since the last service. Reset the oil life system when the oil is changed. See *Engine Oil Life System on page 10-9*.

Tire Rotation and Required Services Every 12 000 km/7,500 mi

Rotate the tires, if recommended for the vehicle, and perform the following services. See *Tire Rotation on page 10-49*.

- Check engine oil level and oil life percentage. If needed, change engine oil and filter, and reset oil life system. See *Engine Oil on page 10-7* and *Engine Oil Life System on page 10-9*.
- Check engine coolant level. See *Engine Coolant on page 10-12*.
- Check windshield washer fluid level. See *Washer Fluid on page 10-19*.

- Visually inspect windshield wiper blades for wear, cracking, or contamination. See *Exterior Care on page 10-74*. Replace worn or damaged wiper blades. See *Wiper Blade Replacement on page 10-25*.
- Check tire inflation pressures. See *Tire Pressure on page 10-43*.
- Inspect tire wear. See *Tire Inspection on page 10-48*.
- Visually check for fluid leaks.
- Inspect engine air cleaner filter. See *Engine Air Cleaner/Filter on page 10-11*.
- Inspect brake system.

11-4 Service and Maintenance

- Visually inspect steering, suspension, and chassis components for damaged, loose, or missing parts or signs of wear. See *Exterior Care* on page 10-74.
- Check restraint system components. See *Safety System Check* on page 3-21.
- Visually inspect fuel system for damage or leaks.
- Visually inspect exhaust system and nearby heat shields for loose or damaged parts.
- Lubricate body components. See *Exterior Care* on page 10-74.
- Check starter switch. See *Starter Switch Check* on page 10-23.
- Check automatic transmission shift lock control function. See *Automatic Transmission Shift Lock Control Function Check* on page 10-24.
- Check ignition transmission lock. See *Ignition Transmission Lock Check* on page 10-24.
- Check parking brake and automatic transmission park mechanism. See *Park Brake and P (Park) Mechanism Check* on page 10-24.
- Check accelerator pedal for damage, high effort, or binding. Replace if needed.
- Visually inspect gas strut for signs of wear, cracks, or other damage. Check the hold open ability of the strut. See your dealer if service is required.
- Inspect sunroof track and seal, if equipped. See *Sunroof* on page 2-19.

11-6 Service and Maintenance

Footnotes — Maintenance Schedule Additional Required Services - Normal

(1) Or every two years, whichever comes first. More frequent replacement may be needed if the vehicle is driven in areas with heavy traffic, areas with poor air quality, or areas with high dust levels. Replacement may also be needed if there is a reduction in air flow, excessive window fogging, or odors.

(2) Check all fuel and vapor lines and hoses for proper hook-up, routing, and condition.

(3) Or every four years, whichever comes first.

(4) Do not directly power wash the transfer case output seals. High pressure water can overcome the seals and contaminate the transfer case fluid. Contaminated fluid will decrease the life of the transfer case and should be replaced.

(5) Or every five years, whichever comes first. See *Cooling System* on page 10-12.

(6) Or every 10 years, whichever comes first. Inspect for fraying, excessive cracking, or damage; replace, if needed.

(7) Or every 10 years, whichever comes first.

Maintenance Schedule Additional Required Services - Severe	12 000 km/7,500 mi	24 000 km/15,000 mi	36 000 km/22,500 mi	48 000 km/30,000 mi	60 000 km/37,500 mi	72 000 km/45,000 mi	84 000 km/52,500 mi	96 000 km/60,000 mi	108 000 km/67,500 mi	120 000 km/75,000 mi	132 000 km/82,500 mi	144 000 km/90,000 mi	156 000 km/97,500 mi	168 000 km/105,000 mi	180 000 km/112,500 mi	192 000 km/120,000 mi	204 000 km/127,500 mi	216 000 km/135,000 mi	228 000 km/142,500 mi	240 000 km/150,000 mi
Rotate tires and perform Required Services. Check engine oil level and oil life percentage. Change engine oil and filter, if needed.	✓	✓	✓	✓	✓	✓	✓	✓	✓	✓	✓	✓	✓	✓	✓	✓	✓	✓	✓	✓
Replace passenger compartment air filter. (1)			✓			✓			✓			✓			✓			✓		
Inspect evaporative control system. (2)						✓						✓							✓	
Replace engine air cleaner filter. (3)						✓						✓							✓	
Change automatic transmission fluid.						✓						✓							✓	
Change transfer case fluid, if equipped with AWD. (4)						✓						✓							✓	
Replace spark plugs. Inspect spark plug wires.													✓							
Drain and fill engine cooling system. (5)																				✓
Visually inspect accessory drive belts. (6)																				✓
Replace brake fluid. (7)																				✓

Footnotes — Maintenance Schedule Additional Required Services - Severe

(1) Or every two years, whichever comes first. More frequent replacement may be needed if the

vehicle is driven in areas with heavy traffic, areas with poor air quality, or areas with high dust levels. Replacement may also be needed if there is a reduction in air flow, excessive window fogging, or odors.

(2) Check all fuel and vapor lines and hoses for proper hook-up, routing, and condition.

(3) Or every four years, whichever comes first.

(4) Do not directly power wash the transfer case output seals. High pressure water can overcome the seals and contaminate the transfer case fluid. Contaminated fluid will decrease the life of the transfer case and should be replaced.

(5) Or every five years, whichever comes first. See *Cooling System on page 10-12*.

(6) Or every 10 years, whichever comes first. Inspect for fraying, excessive cracking, or damage; replace, if needed.

(7) Or every 10 years, whichever comes first.

Special Application Services

- Severe Commercial Use Vehicles Only: Lubricate chassis components every 5 000 km/ 3,000 mi.
- Have underbody flushing service performed. See "Underbody Maintenance" in *Exterior Care on page 10-74*.

Additional Maintenance and Care

Your vehicle is an important investment and caring for it properly may help to avoid future costly repairs. To maintain vehicle performance, additional maintenance services may be required.

It is recommended that your dealer perform these services — their trained dealer technicians know your vehicle best. Your dealer can also perform a thorough assessment with a multi-point inspection to recommend when your vehicle may need attention.

The following list is intended to explain the services and conditions to look for that may indicate services are required.

Battery

The battery supplies power to start the engine and operate any additional electrical accessories.

- To avoid break-down or failure to start the vehicle, maintain a battery with full cranking power.
- Trained dealer technicians have the diagnostic equipment to test the battery and ensure that the connections and cables are corrosion-free.

Belts

- Belts may need replacing if they squeak or show signs of cracking or splitting.
- Trained dealer technicians have access to tools and equipment to inspect the belts and recommend adjustment or replacement when necessary.

Brakes

Brakes stop the vehicle and are crucial to safe driving.

- Signs of brake wear may include chirping, grinding, or squealing noises, or difficulty stopping.
- Trained dealer technicians have access to tools and equipment to inspect the brakes and recommend quality parts engineered for the vehicle.

Fluids

Proper fluid levels and approved fluids protect the vehicle's systems and components. See *Recommended Fluids and Lubricants on page 11-12* for GM approved fluids.

- Engine oil and windshield washer fluid levels should be checked at every fuel fill.
- Instrument cluster lights may come on to indicate that fluids may be low and need to be filled.

Hoses

Hoses transport fluids and should be regularly inspected to ensure that there are no cracks or leaks. With a multi-point inspection, your dealer can inspect the hoses and advise if replacement is needed.

Lamps

Properly working headlamps, taillamps, and brake lamps are important to see and be seen on the road.

- Signs that the headlamps need attention include dimming, failure to light, cracking, or damage. The brake lamps need to be checked periodically to ensure that they light when braking.
- With a multi-point inspection, your dealer can check the lamps and note any concerns.

11-10 Service and Maintenance

Shocks and Struts

Shocks and struts help aid in control for a smoother ride.

- Signs of wear may include steering wheel vibration, bounce/sway while braking, longer stopping distance, or uneven tire wear.
- As part of the multi-point inspection, trained dealer technicians can visually inspect the shocks and struts for signs of leaking, blown seals, or damage, and can advise when service is needed.

Tires

Tires need to be properly inflated, rotated, and balanced. Maintaining the tires can save money and fuel, and can reduce the risk of tire failure.

- Signs that the tires need to be replaced include three or more visible treadwear indicators; cord or fabric showing through the rubber; cracks or cuts in the tread or sidewall; or a bulge or split in the tire.

- Trained dealer technicians can inspect and recommend the right tires. Your dealer can also provide tire/wheel balancing services to ensure smooth vehicle operation at all speeds. Your dealer sells and services name brand tires.

Vehicle Care

To help keep the vehicle looking like new, vehicle care products are available from your dealer. For information on how to clean and protect the vehicle's interior and exterior, see *Interior Care* on page 10-78 and *Exterior Care* on page 10-74.

Wheel Alignment

Wheel alignment is critical for ensuring that the tires deliver optimal wear and performance.

- Signs that the alignment may need to be adjusted include pulling, improper vehicle handling, or unusual tire wear.
- Your dealer has the required equipment to ensure proper wheel alignment.

Windshield

For safety, appearance, and the best viewing, keep the windshield clean and clear.

- Signs of damage include scratches, cracks, and chips.
- Trained dealer technicians can inspect the windshield and recommend proper replacement if needed.

Wiper Blades

Wiper blades need to be cleaned and kept in good condition to provide a clear view.

- Signs of wear include streaking, skipping across the windshield, and worn or split rubber.
- Trained dealer technicians can check the wiper blades and replace them when needed.

Recommended Fluids, Lubricants, and Parts

Recommended Fluids and Lubricants

Usage	Fluid/Lubricant
Engine Oil	Use only engine oil licensed to the dexos1 [®] specification of the proper SAE viscosity grade. ACDelco dexos1 Synthetic Blend is recommended. See <i>Engine Oil on page 10-7</i> .
Engine Coolant	50/50 mixture of clean, drinkable water and use only DEX-COOL [®] Coolant. See <i>Engine Coolant on page 10-12</i> .
Hydraulic Brake System	DOT 3 Hydraulic Brake Fluid (GM Part No. 19299818, in Canada 19299819).
Windshield Washer	Automotive windshield washer fluid that meets regional freeze protection requirements.
Hydraulic Power Steering System	DEXRON [®] -VI Automatic Transmission Fluid.
Automatic Transmission	DEXRON [®] -VI Automatic Transmission Fluid.
Carrier Assembly – Differential (Rear Drive Module) and Transfer Case (Power Transfer Unit)	SAE 75W-90 Synthetic Axle Lubricant (GM Part No. 88900401, in Canada 89021678).
Key Lock Cylinders	Multi-Purpose Lubricant, Superlube (GM Part No. 12346241, in Canada 10953474).

Usage	Fluid/Lubricant
Hood Latch Assembly, Secondary Latch, Pivots, Spring Anchor, and Release Pawl	Lubriplate Lubricant Aerosol (GM Part No. 89021668, in Canada 89021674) or lubricant meeting requirements of NLGI #2, Category LB or GC-LB.
Hood and Door Hinges	Multi-Purpose Lubricant, Superlube (GM Part No. 12346241, in Canada 10953474).
Weatherstrip Conditioning	Weatherstrip Lubricant (GM Part No. 3634770, in Canada 10953518) or Dielectric Silicone Grease (GM Part No. 12345579, in Canada 10953481).

Maintenance Replacement Parts

Replacement parts identified below by name, part number, or specification can be obtained from your dealer.

Part	GM Part Number	ACDelco Part Number
Engine Air Cleaner/Filter	15278634	A3083C
Engine Oil Filter	89017525	PF63
Passenger Compartment Air Filter	20958479	CF179C
Spark Plugs	12622561	41-109
Wiper Blades		
Front Driver – 62.5 cm (24.6 in)	25941805	—
Front Passenger – 53.0 cm (20.8 in)	25941804	—
Rear – 30.0 cm (11.6 in)	20865139	—

11-14 Service and Maintenance

Maintenance Records

After the scheduled services are performed, record the date, odometer reading, who performed the service, and the type of services performed in the boxes provided. Retain all maintenance receipts.

Date	Odometer Reading	Serviced By	Services Performed

Technical Data

Vehicle Identification

Vehicle Identification Number (VIN)	12-1
Service Parts Identification Label	12-1

Vehicle Data

Capacities and Specifications	12-2
Engine Drive Belt Routing ...	12-4

Vehicle Identification

Vehicle Identification Number (VIN)



This legal identifier is in the front corner of the instrument panel, on the left side of the vehicle. It can be seen through the windshield from outside. The VIN also appears on the Vehicle Certification and Service Parts labels and certificates of title and registration.

Engine Identification

The eighth character in the VIN is the engine code. This code identifies the vehicle's engine, specifications, and replacement parts. See "Engine Specifications" under *Capacities and Specifications* on page 12-2 for the vehicle's engine code.

Service Parts Identification Label

This label, on the inside of the glove box, has the following information:

- Vehicle Identification Number (VIN).
- Model designation.
- Paint information.
- Production options and special equipment.

Do not remove this label from the vehicle.

Vehicle Data

Capacities and Specifications

The following approximate capacities are given in metric and English conversions. See *Recommended Fluids and Lubricants on page 11-12* for more information.

Application	Capacities	
	Metric	English
Air Conditioning Refrigerant	For the air conditioning system refrigerant type and charge amount, see the refrigerant label under the hood. See your dealer for more information.	
Cooling System	11.3 L	11.9 qt
Engine Oil with Filter	5.7 L	6.0 qt
Fuel Tank	83.3 L	22.0 gal
Transfer Case Fluid	1.0 L	1.0 qt
Wheel Nut Torque	190 N•m	140 lb ft

All capacities are approximate. When adding, be sure to fill to the approximate level, as recommended in this manual. Recheck fluid level after filling.

Engine Specifications

Engine	VIN Code	Transmission	Spark Plug Gap
3.6L V6 Engine	D	Automatic	0.95–1.10 mm (0.037–0.043 in)

12-4 Technical Data

Engine Drive Belt Routing

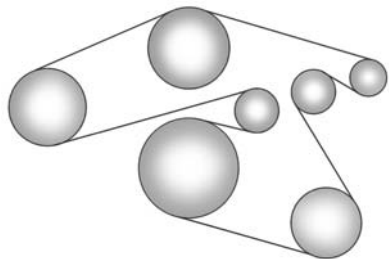

Customer Information

Customer Information

Customer Satisfaction Procedure	13-1
Customer Assistance Offices	13-3
Customer Assistance for Text Telephone (TTY) Users	13-4
Online Owner Center	13-4
GM Mobility Reimbursement Program	13-5
Roadside Assistance Program	13-5
Scheduling Service Appointments	13-7
Courtesy Transportation Program	13-7
Collision Damage Repair	13-8
Service Publications Ordering Information	13-11
Radio Frequency Identification (RFID)	13-12
Radio Frequency Statement	13-12

Reporting Safety Defects

Reporting Safety Defects to the United States Government	13-12
Reporting Safety Defects to the Canadian Government	13-13
Reporting Safety Defects to General Motors	13-13

Vehicle Data Recording and Privacy

Vehicle Data Recording and Privacy	13-14
Event Data Recorders	13-14
OnStar®	13-15
Infotainment System	13-15

Customer Information

Customer Satisfaction Procedure

Your satisfaction and goodwill are important to your dealer and to Chevrolet. Normally, any concerns with the sales transaction or the operation of the vehicle will be resolved by your dealer's sales or service departments. Sometimes, however, despite the best intentions of all concerned, misunderstandings can occur. If your concern has not been resolved to your satisfaction, the following steps should be taken:

STEP ONE: Discuss your concern with a member of dealership management. Normally, concerns can be quickly resolved at that level. If the matter has already been reviewed with the sales, service, or parts manager, contact the owner of your dealership or the general manager.

13-2 Customer Information

STEP TWO: If after contacting a member of dealership management, it appears your concern cannot be resolved by your dealership without further help, in the U.S., call the Chevrolet Customer Assistance Center at 1-800-222-1020. In Canada, call General Motors of Canada Customer Care Centre at 1-800-263-3777 (English), or 1-800-263-7854 (French).

We encourage you to call the toll-free number in order to give your inquiry prompt attention. Have the following information available to give the Customer Assistance representative:

- Vehicle Identification Number (VIN). This is available from the vehicle registration or title, or the plate at the top left of the instrument panel and visible through the windshield.
- Dealership name and location.
- Vehicle delivery date and present mileage.

When contacting Chevrolet, remember that your concern will likely be resolved at a dealer's facility. That is why we suggest following Step One first.

STEP THREE — U.S. Owners: Both General Motors and your dealer are committed to making sure you are completely satisfied with your new vehicle. However, if you continue to remain unsatisfied after following the procedure outlined in Steps One and Two, you can file with the Better Business Bureau (BBB) Auto Line[®] Program to enforce your rights.

The BBB Auto Line Program is an out-of-court program administered by the Council of Better Business Bureaus to settle automotive disputes regarding vehicle repairs or the interpretation of the New Vehicle Limited Warranty. Although you may be required to resort to this informal dispute resolution program prior to filing a court action, use of the program is free of charge and your case will generally be heard within

40 days. If you do not agree with the decision given in your case, you may reject it and proceed with any other venue for relief available to you.

You may contact the BBB Auto Line Program using the toll-free telephone number or write them at the following address:

BBB Auto Line Program
Council of Better Business Bureaus,
Inc.

4200 Wilson Boulevard
Suite 800
Arlington, VA 22203-1838

Telephone: 1-800-955-5100
www.dr.bbb.org/goauto

This program is available in all 50 states and the District of Columbia. Eligibility is limited by vehicle age, mileage, and other factors. General Motors reserves the right to change eligibility limitations and/or discontinue its participation in this program.

STEP THREE — Canadian

Owners: In the event that you do not feel your concerns have been addressed after following the procedure outlined in Steps One and Two, General Motors of Canada Limited wants you to be aware of its participation in a no-charge Mediation/Arbitration Program. General Motors of Canada Limited has committed to binding arbitration of owner disputes involving factory-related vehicle service claims. The program provides for the review of the facts involved by an impartial third party arbiter, and may include an informal hearing before the arbiter. The program is designed so that the entire dispute settlement process, from the time you file your complaint to the final decision, should be completed in about 70 days. We believe our impartial program offers advantages over courts in most jurisdictions because it is informal, quick, and free of charge.

For further information concerning eligibility in the Canadian Motor Vehicle Arbitration Plan (CAMVAP), call toll-free 1-800-207-0685, or call the General Motors Customer Care Centre, 1-800-263-3777 (English), 1-800-263-7854 (French), or write to:

The Mediation/Arbitration Program
c/o Customer Care Centre
General Motors of Canada Limited
Mail Code: CA1-163-005
1908 Colonel Sam Drive
Oshawa , Ontario L1H 8P7

Your inquiry should be accompanied by the Vehicle Identification Number (VIN).

Customer Assistance Offices

Chevrolet encourages customers to call the toll-free number for assistance. However, if a customer wishes to write or e-mail Chevrolet, the letter should be addressed to:

United States and Puerto Rico

Chevrolet Motor Division
Chevrolet Customer Assistance
Center
P.O. Box 33170
Detroit, MI 48232-5170
www.Chevrolet.com

1-800-222-1020
1-800-833-2438 (For Text
Telephone Devices (TTYs))
Roadside Assistance:
1-800-243-8872

From U.S. Virgin Islands:
1-800-496-9994

13-4 Customer Information

Canada

General Motors of Canada Limited
Customer Care Centre,
Mail Code: CA1-163-005
1908 Colonel Sam Drive
Oshawa, Ontario L1H 8P7
www.gm.ca

1-800-263-3777 (English)
1-800-263-7854 (French)
1-800-263-3830 (For Text
Telephone devices (TTYs))
Roadside Assistance:
1-800-268-6800

Overseas

Please contact the local General
Motors Business Unit.

Customer Assistance for Text Telephone (TTY) Users

To assist customers who are deaf,
hard of hearing, or speech-impaired
and who use Text Telephones
(TTYs), Chevrolet has TTY
equipment available at its Customer

Assistance Center. Any TTY user in
the U.S. can communicate with
Chevrolet by dialing:
1-800-833-2438. TTY users in
Canada can dial 1-800-263-3830.

Online Owner Center

Online Owner Experience (U.S.) my.chevrolet.com

The Chevrolet online owner
experience is a one-stop resource
that allows interaction with
Chevrolet and keeps important
vehicle-specific information in one
place.

Membership Benefits

 **(Vehicle Information):**
Download owner manuals and view
vehicle-specific how-to videos.

 **(Maintenance Information):**
View maintenance schedules,
alerts, OnStar onboard vehicle
diagnostic information, and
schedule service appointments.

 **(Service History):** View and
print dealer-recorded service
records and self-recorded service
records.

 **(Preferred Dealer
Information):** Select a preferred
dealer and view dealer location,
maps, phone numbers, and hours.

 **(Warranty Tracking
Information):** Track the vehicle's
warranty information.

 **(Recall Information):** View
active recalls by Vehicle
Identification Number (VIN). See
Vehicle Identification Number (VIN)
on page 12-1.

 **(Other Account Information):**
View GM Card, SiriusXM Satellite
radio (if equipped), and OnStar
account information.

 **(Live Chat Support):** Chat live
with online help representatives.

Visit my.chevrolet.com to register
your vehicle.

Chevrolet Owner Centre (Canada) chevroletowner.ca

Take a trip to the Chevrolet Owner Centre:

- Chat live with online help representatives.
- Use the Vehicle Tools section.
- Access third party enthusiast sites and social media networks.
- Locate owner resources such as lease-end, financing, and warranty information.
- Retrieve your favorite articles, quizzes, tips, and multimedia galleries organized into the Features and Auto Care Sections.
- Download the owner manual for your vehicle, quickly and easily.
- Find the Chevrolet-recommended maintenance services for your vehicle.

GM Mobility Reimbursement Program



This program is available to qualified applicants for cost reimbursement of eligible aftermarket adaptive equipment required for the vehicle, such as hand controls or a wheelchair/scooter lift for the vehicle.

For more information on the limited offer, visit www.gmmobility.com or call the GM Mobility Assistance Center at 1-800-323-9935. Text Telephone (TTY) users, call 1-800-833-9935.

General Motors of Canada also has a Mobility Program. Visit www.gm.ca or call 1-800-GM-DRIVE (463-7483) for details. TTY users call 1-800-263-3830.

Roadside Assistance Program

For U.S.-purchased vehicles, call 1-800-243-8872. (Text Telephone (TTY): 1-888-889-2438.)

For Canadian-purchased vehicles, call 1-800-268-6800.

Service is available 24 hours a day, 365 days a year.

Calling for Assistance

When calling Roadside Assistance, have the following information ready:

- Your name, home address, and home telephone number.
- Telephone number of your location.
- Location of the vehicle.

13-6 Customer Information

- Model, year, color, and license plate number of the vehicle.
- Odometer reading, Vehicle Identification Number (VIN), and delivery date of the vehicle.
- Description of the problem.

Coverage

Services are provided up to 5 years/160 000 km (100,000 mi), whichever comes first.

In the U.S., anyone driving the vehicle is covered. In Canada, a person driving the vehicle without permission from the owner is not covered.

Roadside Assistance is not a part of the New Vehicle Limited Warranty. General Motors North America and Chevrolet reserve the right to make any changes or discontinue the Roadside Assistance program at any time without notification.

General Motors North America and Chevrolet reserve the right to limit services or payment to an owner or

driver if they decide the claims are made too often, or the same type of claim is made many times.

Services Provided

- **Emergency Fuel Delivery:** Delivery of enough fuel for the vehicle to get to the nearest service station.
- **Lock-Out Service:** Service to unlock the vehicle if you are locked out. A remote unlock may be available if you have OnStar. For security reasons, the driver must present identification before this service is given.
- **Emergency Tow from a Public Road or Highway:** Tow to the nearest Chevrolet dealer for warranty service, or if the vehicle was in a crash and cannot be driven. Assistance is not given when the vehicle is stuck in the sand, mud, or snow.
- **Flat Tire Change:** Service to change a flat tire with the spare tire. The spare tire, if equipped,

must be in good condition and properly inflated. It is the owner's responsibility for the repair or replacement of the tire if it is not covered by the warranty.

- **Battery Jump Start:** Service to jump start a dead battery.

Services Not Included in Roadside Assistance

- Impound towing caused by violation of any laws.
- Legal fines.
- Mounting, dismounting, or changing of snow tires, chains, or other traction devices.

Service is not provided if a vehicle is in an area that is not accessible to the service vehicle or is not a regularly traveled or maintained public road, which includes ice and winter roads. Off-road use is not covered.

Services Specific to Canadian-Purchased Vehicles

- **Fuel Delivery:** Reimbursement is up to 7 liters. Diesel fuel delivery may be restricted. Propane and other fuels are not provided through this service.
- **Lock-Out Service:** Vehicle registration is required.
- **Trip Interruption Benefits and Assistance:** Must be over 150 kilometers from where your trip was started to qualify. General Motors of Canada Limited requires pre-authorization, original detailed receipts, and a copy of the repair orders. Once authorization has been received, the Roadside Assistance advisor will help to make arrangements and explain how to receive payment.
- **Alternative Service:** If assistance cannot be provided right away, the Roadside Assistance advisor may give

permission to get local emergency road service. You will receive payment, up to \$100, after sending the original receipt to Roadside Assistance. Mechanical failures may be covered, however any cost for parts and labor for repairs not covered by the warranty are the owner responsibility.

Scheduling Service Appointments

When the vehicle requires warranty service, contact your dealer and request an appointment. By scheduling a service appointment and advising the service consultant of your transportation needs, your dealer can help minimize your inconvenience.

If the vehicle cannot be scheduled into the service department immediately, keep driving it until it can be scheduled for service, unless, of course, the problem is

safety related. If it is, please call your dealership, let them know this, and ask for instructions.

If your dealer requests you to bring the vehicle for service, you are urged to do so as early in the work day as possible to allow for same-day repair.

Courtesy Transportation Program

To enhance your ownership experience, we and our participating dealers are proud to offer Courtesy Transportation, a customer support program for vehicles with the Bumper-to-Bumper (Base Warranty Coverage period in Canada), extended powertrain, and/or hybrid-specific warranties in both the U.S. and Canada.

Several Courtesy Transportation options are available to assist in reducing inconvenience when warranty repairs are required.

13-8 Customer Information

Courtesy Transportation is not a part of the New Vehicle Limited Warranty. A separate booklet entitled "Limited Warranty and Owner Assistance Information" furnished with each new vehicle provides detailed warranty coverage information.

Transportation Options

Warranty service can generally be completed while you wait. However, if you are unable to do so, your dealer may offer the following transportation options:

Shuttle Service

This includes one-way or round-trip shuttle service within reasonable time and distance parameters of your dealer's area.

Public Transportation or Fuel Reimbursement

If overnight warranty repairs are needed, and public transportation is used, the expense must be supported by original receipts and within the maximum amount allowed

by GM for shuttle service. If U.S. customers arrange their own transportation, limited reimbursement for reasonable fuel expenses may be available. Claim amounts should reflect actual costs and be supported by original receipts. See your dealer for information.

Courtesy Rental Vehicle

For an overnight warranty repair, the dealer may provide an available courtesy rental vehicle or provide for reimbursement of a rental vehicle. Reimbursement is limited and must be supported by original receipts as well as a signed and completed rental agreement and meet state/provincial, local, and rental vehicle provider requirements. Requirements vary and may include minimum age requirements, insurance coverage, credit card, etc. Additional fees such as fuel usage charges, taxes, levies, usage fees, excessive mileage, or rental usage beyond the completion of the repair are also your responsibility.

It may not be possible to provide a like vehicle as a courtesy rental.

Additional Program Information

All program options, such as shuttle service, may not be available at every dealer. Contact your dealer for specific availability.

General Motors reserves the right to unilaterally modify, change, or discontinue Courtesy Transportation at any time and to resolve all questions of claim eligibility pursuant to the terms and conditions described herein at its sole discretion.

Collision Damage Repair

If the vehicle is involved in a collision and it is damaged, have the damage repaired by a qualified technician using the proper equipment and quality replacement parts. Poorly performed collision repairs diminish the vehicle resale

value, and safety performance can be compromised in subsequent collisions.

Collision Parts

Genuine GM Collision parts are new parts made with the same materials and construction methods as the parts with which the vehicle was originally built. Genuine GM Collision parts are the best choice to ensure that the vehicle's designed appearance, durability, and safety are preserved. The use of Genuine GM parts can help maintain the GM New Vehicle Limited Warranty.

Recycled original equipment parts may also be used for repair. These parts are typically removed from vehicles that were total losses in prior crashes. In most cases, the parts being recycled are from undamaged sections of the vehicle. A recycled original equipment GM part may be an acceptable choice to maintain the vehicle's originally designed appearance and safety performance; however, the history of

these parts is not known. Such parts are not covered by the GM New Vehicle Limited Warranty, and any related failures are not covered by that warranty.

Aftermarket collision parts are also available. These are made by companies other than GM and may not have been tested for the vehicle. As a result, these parts may fit poorly, exhibit premature durability/corrosion problems, and may not perform properly in subsequent collisions. Aftermarket parts are not covered by the GM New Vehicle Limited Warranty, and any vehicle failure related to such parts is not covered by that warranty.

Repair Facility

GM also recommends that you choose a collision repair facility that meets your needs before you ever need collision repairs. Your dealer may have a collision repair center with GM-trained technicians and state-of-the-art equipment, or be able to recommend a collision repair

center that has GM-trained technicians and comparable equipment.

Insuring the Vehicle

Protect your investment in the GM vehicle with comprehensive and collision insurance coverage. There are significant differences in the quality of coverage afforded by various insurance policy terms. Many insurance policies provide reduced protection to the GM vehicle by limiting compensation for damage repairs through the use of aftermarket collision parts. Some insurance companies will not specify aftermarket collision parts. When purchasing insurance, we recommend that you ensure that the vehicle will be repaired with GM original equipment collision parts. If such insurance coverage is not available from your current insurance carrier, consider switching to another insurance carrier.

13-10 Customer Information

If the vehicle is leased, the leasing company may require you to have insurance that ensures repairs with Genuine GM Original Equipment Manufacturer (OEM) parts or Genuine Manufacturer replacement parts. Read the lease carefully, as you may be charged at the end of the lease for poor quality repairs.

If a Crash Occurs

If there has been an injury, call emergency services for help. Do not leave the scene of a crash until all matters have been taken care of. Move the vehicle only if its position puts you in danger, or you are instructed to move it by a police officer.

Give only the necessary information to police and other parties involved in the crash.

For emergency towing see *Roadside Assistance Program on page 13-5*.

Gather the following information:

- Driver name, address, and telephone number.
- Driver license number.
- Owner name, address, and telephone number.
- Vehicle license plate number.
- Vehicle make, model, and model year.
- Vehicle Identification Number (VIN).
- Insurance company and policy number.
- General description of the damage to the other vehicle.

Choose a reputable repair facility that uses quality replacement parts. See “Collision Parts” earlier in this section.

If the airbag has inflated, see *What Will You See after an Airbag Inflates?* on page 3-28.

Managing the Vehicle Damage Repair Process

In the event that the vehicle requires damage repairs, GM recommends that you take an active role in its repair. If you have a pre-determined repair facility of choice, take the vehicle there, or have it towed there. Specify to the facility that any required replacement collision parts be original equipment parts, either new Genuine GM parts or recycled original GM parts. Remember, recycled parts will not be covered by the GM vehicle warranty.

Insurance pays the bill for the repair, but you must live with the repair. Depending on your policy limits, your insurance company may initially value the repair using aftermarket parts. Discuss this with the repair professional, and insist on Genuine GM parts. Remember, if the vehicle is leased, you may be obligated to have the vehicle repaired with Genuine GM parts, even if your insurance coverage does not pay the full cost.

If another party's insurance company is paying for the repairs, you are not obligated to accept a repair valuation based on that insurance company's collision policy repair limits, as you have no contractual limits with that company. In such cases, you can have control of the repair and parts choices as long as the cost stays within reasonable limits.

Service Publications Ordering Information

Service Manuals

Service Manuals have the diagnosis and repair information on the engines, transmission, axle, suspension, brakes, electrical, steering, body, etc.

Service Bulletins

Service Bulletins give additional technical service information needed to knowledgeable service General Motors cars and trucks.

Each bulletin contains instructions to assist in the diagnosis and service of the vehicle.

Owner Information

Owner publications are written specifically for owners and intended to provide basic operational information about the vehicle. The Owner Manual includes the Maintenance Schedule for all models.

In-Portfolio: Includes a Portfolio, Owner Manual, and Warranty Manual.

RETAIL SELL PRICE: \$35.00 – \$40.00 (U.S.) plus handling and shipping fees.

Without Pouch: Owner Manual only.

RETAIL SELL PRICE:
\$25.00 (U.S.) plus handling and shipping fees.

Current and Past Models

Technical Service Bulletins and Manuals are available for current and past model GM vehicles.

ORDER TOLL FREE:

1-800-551-4123 Monday – Friday
8:00 AM – 6:00 PM Eastern Time

For Credit Card Orders Only
(VISA-MasterCard-Discover), see
Helm, Inc. at: www.helminc.com.

Or write to:

Helm, Incorporated
Attention: Customer Service
47911 Halyard Drive
Plymouth, MI 48170

Prices are subject to change without notice and without incurring obligation. Allow ample time for delivery.

All listed prices are quoted in U.S. funds. Make checks payable in U.S. funds.

Radio Frequency Identification (RFID)

RFID technology is used in some vehicles for functions such as tire pressure monitoring and ignition system security, as well as in connection with conveniences such as Remote Keyless Entry (RKE) transmitters for remote door locking/unlocking and starting, and in-vehicle transmitters for garage door openers. RFID technology in GM vehicles does not use or record personal information or link with any other GM system containing personal information.

Radio Frequency Statement

This vehicle has systems that operate on a radio frequency that complies with Part 15/Part 18 of the Federal Communications Commission (FCC) rules and with Industry Canada Standards RSS-GEN/210/220/310.

Operation is subject to the following two conditions:

1. The device may not cause harmful interference.
2. The device must accept any interference received, including interference that may cause undesired operation of the device.

Changes or modifications to any of these systems by other than an authorized service facility could void authorization to use this equipment.

Reporting Safety Defects

Reporting Safety Defects to the United States Government

If you believe that your vehicle has a defect which could cause a crash or could cause injury or death, you should immediately inform the National Highway Traffic Safety Administration (NHTSA) in addition to notifying General Motors.

If NHTSA receives similar complaints, it may open an investigation, and if it finds that a safety defect exists in a group of vehicles, it may order a recall and remedy campaign. However, NHTSA cannot become involved in individual problems between you, your dealer, or General Motors.

To contact NHTSA, you may call the Vehicle Safety Hotline toll-free at 1-888-327-4236 (TTY: 1-800-424-9153); go to <http://www.safercar.gov>; or write to:

Administrator, NHTSA
1200 New Jersey Avenue, S.E.
Washington, D.C. 20590

You can also obtain other information about motor vehicle safety from <http://www.safercar.gov>.

Reporting Safety Defects to the Canadian Government

If you live in Canada, and you believe that the vehicle has a safety defect, notify Transport Canada immediately, and notify General Motors of Canada Limited. Call Transport Canada at 1-800-333-0510 or write to:

Transport Canada
Road Safety Branch
80 rue Noel
Gatineau , QC J8Z 0A1

Reporting Safety Defects to General Motors

In addition to notifying NHTSA (or Transport Canada) in a situation like this, notify General Motors.

Call 1-800-222-1020, or write:

Chevrolet Motor Division
Chevrolet Customer Assistance
Center
P.O. Box 33170
Detroit, MI 48232-5170

In Canada, call 1-800-263-3777 (English) or 1-800-263-7854 (French), or write:

General Motors of Canada Limited
Customer Care Centre,
Mail Code: CA1-163-005
1908 Colonel Sam Drive
Oshawa, Ontario L1H 8P7

Vehicle Data Recording and Privacy

The vehicle has a number of computers that record information about the vehicle's performance and how it is driven. For example, the vehicle uses computer modules to monitor and control engine and transmission performance, to monitor the conditions for airbag deployment and deploy them in a crash, and, if equipped, to provide antilock braking to help the driver control the vehicle. These modules may store data to help the dealer technician service the vehicle.

Some modules may also store data about how the vehicle is operated, such as rate of fuel consumption or average speed. These modules may retain personal preferences, such as radio presets, seat positions, and temperature settings.

Event Data Recorders

This vehicle is equipped with an event data recorder (EDR). The main purpose of an EDR is to record, in certain crash or near crash-like situations, such as an air bag deployment or hitting a road obstacle, data that will assist in understanding how a vehicle's systems performed. The EDR is designed to record data related to vehicle dynamics and safety systems for a short period of time, typically 30 seconds or less. The EDR in this vehicle is designed to record such data as:

- How various systems in your vehicle were operating;
- Whether or not the driver and passenger safety belts were buckled/fastened;
- How far (if at all) the driver was depressing the accelerator and/or brake pedal; and,
- How fast the vehicle was traveling.

These data can help provide a better understanding of the circumstances in which crashes and injuries occur. NOTE: EDR data are recorded by your vehicle only if a non-trivial crash situation occurs; no data are recorded by the EDR under normal driving conditions and no personal data (e.g., name, gender, age, and crash location) are recorded. However, other parties, such as law enforcement, could combine the EDR data with the type of personally identifying data routinely acquired during a crash investigation.

To read data recorded by an EDR, special equipment is required, and access to the vehicle or the EDR is needed. In addition to the vehicle manufacturer, other parties, such as law enforcement, that have the special equipment, can read the information if they have access to the vehicle or the EDR.

GM will not access this data or share it with others except: with the consent of the vehicle owner or, if the vehicle is leased, with the consent of the lessee; in response to an official request by police or similar government office; as part of GM's defense of litigation through the discovery process; or, as required by law. Data that GM collects or receives may also be used for GM research needs or may be made available to others for research purposes, where a need is shown and the data is not tied to a specific vehicle or vehicle owner.

OnStar®

If the vehicle is equipped with OnStar® and has an active subscription, additional data may be collected through the OnStar system. This includes information about the vehicle's operation; collisions involving the vehicle; the use of the vehicle and its features; and, in certain situations, the location and approximate GPS speed of the vehicle. Refer to the OnStar Terms and Conditions and Privacy Statement on the OnStar website.

Infotainment System

If the vehicle is equipped with a navigation system as part of the infotainment system, use of the system may result in the storage of destinations, addresses, telephone numbers, and other trip information. See the infotainment manual for information on stored data and for deletion instructions.

OnStar

OnStar Overview

OnStar Overview 14-1

OnStar Services

Emergency 14-2

Security 14-3

Navigation 14-3

Connections 14-4

Vehicle Diagnostics 14-6

OnStar Additional Information

OnStar Additional
Information 14-6

OnStar Overview



 Voice Command Button



 Blue OnStar Button



 Emergency Button

This vehicle may be equipped with a comprehensive, in-vehicle system that can connect to a live OnStar Advisor for Emergency, Security, Navigation, Connection, and Diagnostic Services. OnStar services may require a paid subscription. OnStar requires the vehicle battery and electrical system, cellular service, and GPS satellite signals to be available and operating. OnStar acts as a link to

existing public emergency service providers. OnStar may collect information about you and your vehicle, including location information. See OnStar's Terms and Conditions and Privacy Statement for more details including system limitations at www.onstar.com (U.S.) or www.onstar.ca (Canada).

The OnStar system status light is next to the OnStar buttons. If the status light is:

- Solid Green: System is on.
- Flashing Green: On a call.
- Red: Indicates a problem.
- Off: System is off. Press the blue OnStar button twice to speak with an OnStar Advisor.

Press  or call 1-888-4-ONSTAR (1-888-466-7827) to speak to an Advisor.

Press  to:

- Make a call, end a call, or answer an incoming call.
- Give OnStar Hands-Free Calling voice commands.
- Give OnStar Turn-by-Turn Navigation voice commands. Requires a specific OnStar subscription plan.
- Obtain the WiFi network name, or Service Set Identifier or SSID, and passphrase (if equipped).

Press  to connect to a live Advisor to:

- Verify account information or update contact information.
- Get driving directions. Requires a specific OnStar subscription plan..

- Receive On-Demand Diagnostics for a check of the vehicle's key operating systems.
- Receive Roadside Assistance.
- Manage WiFi Settings (if equipped).

Press  to get a priority connection to an OnStar Emergency Advisor available 24/7 to:

- Get help for an emergency.
- Be a Good Samaritan or respond to an AMBER Alert.
- Get assistance in severe weather or other crisis and evacuation routes.

OnStar Services

Emergency

With Automatic Crash Response, the OnStar system can automatically connect to an OnStar Emergency Advisor. The built-in system can automatically connect to help in certain crashes.

Press  to connect to an OnStar Emergency Advisor. GPS technology is used to identify the vehicle location and can provide important information to emergency personnel. OnStar Emergency Advisors are trained to provide assistance and link to existing public emergency service providers in emergency situations.

With OnStar Crisis Assist, specially trained Crisis Advisors are available 24 hours a day, 7 days a week, to provide a central point of contact, assistance, and information if a crisis occurs.

Security

OnStar provides services including Stolen Vehicle Assistance, Remote Ignition Block, and Roadside Assistance, if equipped. OnStar can unlock the vehicle doors remotely, if equipped with automatic door locks, and can help police locate the vehicle if it is stolen.

Navigation

OnStar navigation requires a specific OnStar subscription plan.

Press  to receive directions or have them sent to the vehicle navigation screen, if equipped. Destinations can also be forwarded to the vehicle from MapQuest.com.

Turn-by-Turn Navigation

1. Press  to connect to a live Advisor.
2. Request directions.
3. Directions are downloaded to the vehicle.

4. Follow the voice-guided commands.

Using Voice Commands During a Planned Route

Cancel Route

1. Press . System responds: “OnStar ready,” then a tone. Say “Cancel route.” System responds: “Do you want to cancel directions?”
2. Say “Yes.” System responds: “OK, request completed, thank you, goodbye.”

Route Preview

1. Press . System responds: “OnStar ready,” then a tone.
2. Say “Route preview.” System responds with the next three maneuvers.

Repeat

1. Press . System responds: “OnStar ready,” then a tone.

2. Say “Repeat.” System responds with the last direction given, then responds with “OnStar ready,” then a tone.

Get My Destination

1. Press . System responds: “OnStar ready,” then a tone.
2. Say “Get my destination.” System responds with the address and the distance to the destination, then responds with “OnStar ready,” then a tone.

Other Navigation Services Available from OnStar

OnStar eNav: Subscribers can send destinations from MapQuest.com to the vehicle Turn-by-Turn Navigation or screen-based navigation system (if equipped). When ready, the directions will be downloaded to the vehicle.

Destination Download: Press , then request the Advisor to download directions to the navigation system in the vehicle (if equipped). After the call ends, press the "Go" button on the navigation screen to begin driving directions.

If directions are downloaded to the navigation system, the route can only be canceled through the navigation system.

Destinations can also be downloaded on the go. For information about eNav or Destination Download, see www.onstar.com (U.S.) or www.onstar.ca (Canada).



Connections

The required specific Onstar subscription plan includes the services that follow to help customers stay connected.

For coverage maps, see www.onstar.com (U.S.) or www.onstar.ca (Canada).

WiFi Connectivity (If Equipped)

The vehicle has a WiFi hotspot that provides a high-speed, wireless Internet connection to connect multiple mobile devices (data plan required).

1. To retrieve WiFi hotspot information, press  and select or say "WiFi settings."
2. The WiFi settings will display the WiFi network name/SSID, passphrase, and level of encryption.
3. To change the SSID or passphrase, press  or call 1-888-4-ONSTAR to connect with an Advisor.

OnStar RemoteLink® Mobile App (If Equipped)

Download the OnStar RemoteLink mobile app to select Apple®, Android™, and BlackBerry® or Windows 7 or 8 mobile devices. From the mobile device, check the vehicle's fuel level, oil life, or tire

pressure (if the vehicle is equipped with the tire pressure monitoring system); or activate remote horn and lights. Also remote start the vehicle (if factory equipped) or unlock the doors from anywhere with a wireless connection (if equipped with automatic locks). With a required specific OnStar subscription plan, a destination can be sent to the vehicle. For OnStar RemoteLink information and compatibility, see www.onstar.com (U.S.) or www.onstar.ca (Canada).

OnStar RemoteLink® Key Fob Services

This feature is included for five years and allows for remote door lock/unlock (if equipped with automatic locks), remote start (if factory equipped), or activation of horn and lights from anywhere with a wireless signal. Download the app and start using it any time during the trial period to get started.

OnStar Hands-Free Calling

This service allows calls to be made and received from the vehicle.

To Make a Call

1. Press . System responds: "OnStar ready."
2. Say "Call." System responds: "Please say the name or number to call."
3. Say the entire number without pausing, including a "1" and the area code. System responds: "OK calling."

Calling 911 Emergency

1. Press . System responds: "OnStar Ready," followed by a tone.
2. Say "Call." System responds: "Please say the name or number to call."
3. Say "911" without pausing. System responds: "911."

4. Say "Call." System responds: "OK, dialing 911."

Retrieve My Number

1. Press . System responds: "OnStar ready."
2. Say "My number." System responds: "Your OnStar Hands-Free Calling number is," then says the number.

End a Call

Press . System responds: "Call ended."

Store a Name Tag for Speed Dialing

1. Press . System responds: "OnStar ready."
2. Say "Store." System responds: "Please say the number you would like to store."
3. Say the entire number without pausing. System responds: "Please say the name tag."

4. Pick a name tag. System responds: "About to store <name tag>. Does that sound OK?"
5. Say "Yes" or say "No" to try again. System responds: "OK, storing <name tag>."

Place a Call Using a Stored Number

1. Press . System responds: "OnStar ready."
2. Say "Call <name tag>." System responds: "OK, calling <name tag>."

Verify Minutes and Expiration

Press  and say "Minutes" then "Verify" to check how many minutes remain and their expiration date.

Vehicle Diagnostics

OnStar Vehicle Diagnostics can perform a vehicle check every month. It will check the engine, transmission, antilock brakes, and other major vehicle systems. It also checks the tire pressures, if the vehicle is equipped with the Tire Pressure Monitoring System. If an On-Demand Diagnostics check is needed, press **On**, and an Advisor can run a check.

OnStar Additional Information

Transferring Service

Press **On** to request account transfer eligibility information. The Advisor can assist in canceling or removing account information.

Selling/Transferring the Vehicle

Call 1-888-4-ONSTAR immediately to terminate your OnStar services if the vehicle is disposed of, sold, transferred, or if the lease ends.

Reactivation for Subsequent Owners

Press **On** and follow the prompts to speak to an Advisor as soon as possible. The Advisor will update vehicle records and explain the OnStar service options available.

How OnStar Service Works

Automatic Crash Response, Emergency Services, Crisis Assist, Stolen Vehicle Assistance, Vehicle Diagnostics, Remote Door Unlock, Roadside Assistance, Turn-by-Turn Navigation, and Hands-Free Calling are available on most vehicles. Not all OnStar services are available everywhere or on all vehicles. For more information, a full description of OnStar services, system limitations, and OnStar terms and conditions:

- Call 1-888-4-ONSTAR (1-888-466-7827).
- See www.onstar.com (U.S.).
- See www.onstar.ca (Canada).
- Call TTY 1-877-248-2080.
- Press **On** to speak with an Advisor.

OnStar services cannot work unless the vehicle is in a place where OnStar has an agreement with a wireless service provider for service

in that area. The wireless service provider must also have coverage, network capacity, reception, and technology compatible with OnStar services. Service involving location information about the vehicle cannot work unless GPS signals are available, unobstructed, and compatible with the OnStar hardware. OnStar services may not work if the OnStar equipment is not properly installed or it has not been properly maintained. If equipment or software is added, connected, or modified, OnStar services may not work. Other problems beyond the control of OnStar may prevent service such as hills, tall buildings, tunnels, weather, electrical system design and architecture of the vehicle, damage to the vehicle in a crash, or wireless phone network congestion or jamming.

See *Radio Frequency Statement on page 13-12*.

Services for People with Disabilities

Advisors provide services to help subscribers with physical disabilities and medical conditions.

Press  for help with:

- Locating a gas station with an attendant to pump gas.
- Finding a hotel, restaurant, etc., that meets accessibility needs.
- Providing directions to the closest hospital or pharmacy in urgent situations.

TTY Users

OnStar has the ability to communicate to deaf, hard-of-hearing, or speech-impaired customers while in the vehicle. The available dealer-installed TTY system can provide in-vehicle access to all of the OnStar services, except Virtual Advisor and OnStar Turn-by-Turn Navigation.

OnStar Personal Identification Number (PIN)

A PIN is needed to access some of the OnStar services, like Remote Door Unlock and Stolen Vehicle Assistance. The PIN will need to be changed the first time when speaking with an Advisor. To change the OnStar PIN, contact an OnStar Advisor by pressing  or calling 1-888-4-ONSTAR.

Warranty

OnStar equipment may be warranted as part of the vehicle warranty.

Languages

The vehicle can be programmed to respond in multiple languages.

Press  and ask for an Advisor. Advisors are available in English, Spanish, and French. Available languages may vary by country.

Potential Issues

OnStar cannot perform Remote Door Unlock or Stolen Vehicle Assistance after the vehicle has been off continuously for five days. After five days, OnStar can contact Roadside Assistance and a locksmith to help gain access to the vehicle.

Global Positioning System (GPS)

- Obstruction of the GPS can occur in a large city with tall buildings; in parking garages; around airports; in tunnels, underpasses; or in an area with very dense trees. If GPS signals are not available, the OnStar system should still operate to call OnStar. However, OnStar could have difficulty identifying the exact location.
- In emergency situations, OnStar can use the last stored GPS location to send to emergency responders.

A temporary loss of GPS can cause loss of the ability to send a Turn-by-Turn Navigation route. The Advisor may give a verbal route or may ask for a call back after the vehicle is driven into an open area.

Cellular and GPS Antennas

Do not place items over or near the antenna to prevent blocking cellular and GPS signal reception. Cellular reception is required for OnStar to send remote signals to the vehicle.

Unable to Connect to OnStar Message

If there is limited cellular coverage or the cellular network has reached maximum capacity, this message may come on. Press  to try the call again or try again after driving a few miles into another cellular area.

Vehicle and Power Issues

OnStar services require a vehicle electrical system, wireless service, and GPS satellite technologies to be available and operating for features

to function properly. These systems may not operate if the battery is discharged or disconnected.

Add-on Electrical Equipment

The OnStar system is integrated into the electrical architecture of the vehicle. Do not add any electrical equipment. See *Add-On Electrical Equipment on page 9-54*. Added electrical equipment may interfere with the operation of the OnStar system and cause it to not operate.

Privacy

The complete OnStar Privacy Statement may be found at www.onstar.com (U.S.), or www.onstar.ca (Canada). We recommend that you review it. If you have any questions, call 1-888-4-ONSTAR (1-888-466-7827) or press  to speak with an Advisor. Users of wireless communications are cautioned that the privacy of any information sent via wireless cellular communications cannot be assured.

Third parties may unlawfully intercept or access transmissions and private communications without consent.

OnStar - libcurl and unzip acknowledgments

Certain OnStar components include libcurl and unzip software. Below are the notices and licenses associated with this software:

libcurl:

COPYRIGHT AND PERMISSION NOTICE

Copyright (c) 1996 - 2010, Daniel Stenberg, <daniel@haxx.se>.

All rights reserved.

Permission to use, copy, modify, and distribute this software for any purpose with or without fee is hereby granted, provided that the above copyright notice and this permission notice appear in all copies.

THE SOFTWARE IS PROVIDED "AS IS," WITHOUT WARRANTY OF ANY KIND, EXPRESS OR IMPLIED, INCLUDING BUT NOT LIMITED TO THE WARRANTIES OF MERCHANTABILITY, FITNESS FOR A PARTICULAR PURPOSE AND NONINFRINGEMENT OF THIRD PARTY RIGHTS. IN NO EVENT SHALL THE AUTHORS OR COPYRIGHT HOLDERS BE LIABLE FOR ANY CLAIM, DAMAGES OR OTHER LIABILITY, WHETHER IN AN ACTION OF CONTRACT, TORT OR OTHERWISE, ARISING FROM, OUT OF OR IN CONNECTION WITH THE SOFTWARE OR THE USE OR OTHER DEALINGS IN THE SOFTWARE.

Except as contained in this notice, the name of a copyright holder shall not be used in advertising or otherwise to promote the sale, use or other dealings in this Software without prior written authorization of the copyright holder.

unzip:

This is version 2005-Feb-10 of the Info-ZIP copyright and license. The definitive version of this document should be available at <ftp://ftp.info-zip.org/pub/infozip/license.html> indefinitely.

Copyright (c) 1990-2005 Info-ZIP. All rights reserved.

For the purposes of this copyright and license, "Info-ZIP" is defined as the following set of individuals:

Mark Adler, John Bush, Karl Davis, Harald Denker, Jean-Michel Dubois, Jean-loup Gailly, Hunter Goatley, Ed Gordon, Ian Gorman, Chris Herborth, Dirk Haase, Greg Hartwig, Robert Heath, Jonathan Hudson, Paul Kienitz, David Kirschbaum, Johnny Lee, Onno van der Linden, Igor Mandrichenko, Steve P. Miller, Sergio Monesi, Keith Owens, George Petrov, Greg Roelofs, Kai Uwe Rommel, Steve Salisbury, Dave Smith, Steven M. Schweda,

Christian Spieler, Cosmin Truta, Antoine Verheijen, Paul von Behren, Rich Wales, Mike White.

This software is provided “as is,” without warranty of any kind, express or implied. In no event shall Info-ZIP or its contributors be held liable for any direct, indirect, incidental, special or consequential damages arising out of the use of or inability to use this software.

Permission is granted to anyone to use this software for any purpose, including commercial applications, and to alter it and redistribute it freely, subject to the following restrictions:

1. Redistributions of source code must retain the above copyright notice, definition, disclaimer, and this list of conditions.
2. Redistributions in binary form (compiled executables) must reproduce the above copyright notice, definition, disclaimer, and this list of conditions in documentation and/or other

materials provided with the distribution. The sole exception to this condition is redistribution of a standard UnZipSFX binary (including SFXWiz) as part of a self-extracting archive; that is permitted without inclusion of this license, as long as the normal SFX banner has not been removed from the binary or disabled.

3. Altered versions—including, but not limited to, ports to new operating systems, existing ports with new graphical interfaces, and dynamic, shared, or static library versions—must be plainly marked as such and must not be misrepresented as being the original source. Such altered versions also must not be misrepresented as being Info-ZIP releases—including, but not limited to, labeling of the altered versions with the names “Info-ZIP” (or any variation thereof, including, but not limited to, different capitalizations),

“Pocket UnZip,” “WiZ” or “MacZip” without the explicit permission of Info-ZIP. Such altered versions are further prohibited from misrepresentative use of the Zip-Bugs or Info-ZIP e-mail addresses or of the Info-ZIP URL(s).

4. Info-ZIP retains the right to use the names “Info-ZIP,” “Zip,” “UnZip,” “UnZipSFX,” “WiZ,” “Pocket UnZip,” “Pocket Zip,” and “MacZip” for its own source and binary releases.

A

Accessories and
Modifications 10-2

Accessory Power 9-18

Add-On Electrical
Equipment 9-54

Additional Information
OnStar® 14-6

Additional Maintenance
and Care 11-8

Adjustments
Lumbar, Front Seats 3-4

Air Cleaner/Filter, Engine 10-11

Air Filter, Passenger
Compartment 8-12

Air Vents 8-11

Airbag System
Check 3-35

How Does an Airbag
Restrain? 3-28

Passenger Sensing
System 3-30

What Makes an Airbag
Inflate? 3-28

Airbag System (cont'd)
What Will You See after an
Airbag Inflates? 3-28

When Should an Airbag
Inflate? 3-27

Where Are the Airbags? 3-25

Airbags
Adding Equipment to the
Vehicle 3-35

Passenger Status Indicator 5-17

Readiness Light 5-16

Servicing Airbag-Equipped
Vehicles 3-34

System Check 3-23

Alarm
Vehicle Security 2-12

Alert
Side Blind Zone (SBZA) 9-36

All-Season Tires 10-36

All-Wheel Drive 9-25, 10-23

AM-FM Radio 7-10, 7-12

Antenna
Multi-band 7-19

Antilock Brake
System (ABS) 9-26

Warning Light 5-21

Appearance Care
Exterior 10-74

Interior 10-78

Armrest Storage 4-2

Assistance Program,
Roadside 13-5

Audio Players 7-20, 7-22

CD 7-20, 7-22

MP3 7-24, 7-29

Audio System
Radio Reception 7-19

Rear Seat (RSA) 7-32

Theft-Deterrent Feature 7-2

Automatic
Door Locks 2-7

Transmission 9-22

Transmission Fluid 10-10

Automatic Transmission
Manual Mode 9-24

Shift Lock Control
Function Check 10-24

Auxiliary
Devices 7-31

B

Battery	10-23
Jump Starting	10-67
Load Management	6-7
Power Protection	6-8
Voltage and Charging Messages	5-34
Blade Replacement, Wiper ...	10-25
Bluetooth Overview	7-34
Brake System Warning Light	5-20
Brakes	10-20
Antilock	9-26
Assist	9-27
Fluid	10-21
Parking	9-27
System Messages	5-35
Braking	9-3
Break-In, New Vehicle	9-14

Bulb Replacement	10-28
Fog Lamps	6-4
Headlamp Aiming	10-26
Headlamps	10-26
License Plate Lamps	10-27
Taillamps, Turn Signal, and Stoplamps	10-26
Buying New Tires	10-51

C

Calibration	5-6
California Fuel Requirements	9-43
Perchlorate Materials Requirements	10-2
Warning	10-2
Camera Rear Vision (RVC)	9-38
Canadian Vehicle Owners	iii
Capacities and Specifications	12-2
Carbon Monoxide Engine Exhaust	9-21
Liftgate	2-8
Winter Driving	9-7

Cargo Cover	4-3
Management System	4-3
Tie-Downs	4-3
Cautions, Danger, and Warnings	iv
CD Player	7-20, 7-22
Center Console Storage	4-2
Chains, Tire	10-55
Charging System Light	5-17
Check Engine Light	5-18
Ignition Transmission Lock	10-24
Child Restraints Infants and Young Children	3-38
Lower Anchors and Tethers for Children	3-44
Older Children	3-36
Securing	3-51, 3-53
Systems	3-41
Circuit Breakers	10-29
Cleaning Exterior Care	10-74
Interior Care	10-78

Climate Control Systems 8-1
 Air Conditioning 8-1
 Dual Automatic 8-4
 Heating 8-1
 Rear 8-9, 8-10
 Clock 5-7, 5-8
 Cluster, Instrument 5-12
 Collision Damage Repair 13-8
 Compact Spare Tire 10-66
 Compartments
 Storage 4-1
 Compass 5-6
 Connections
 OnStar® 14-4
 Control
 Traction and Electronic
 Stability 9-28
 Control of a Vehicle 9-3
 Convenience Net 4-4
 Convex Mirrors 2-14
 Coolant
 Engine 10-12
 Engine Temperature
 Gauge 5-14
 Engine Temperature
 Warning Light 5-23

Cooling System 10-12
 Engine Messages 5-36
 Courtesy Lamps 6-5
 Courtesy Transportation
 Program 13-7
 Cover
 Cargo 4-3
 Engine 10-6
 Cruise Control 9-30
 Light 5-25
 Messages 5-35
 Cupholders 4-2
 Customer Assistance 13-4
 Offices 13-3
 Text Telephone (TTY)
 Users 13-4
 Customer Information
 Service Publications
 Ordering Information 13-11
 Customer Satisfaction
 Procedure 13-1

D

Damage Repair, Collision 13-8
 Danger, Warnings, and
 Cautions iv
 Data Recorders, Event 13-14
 Daytime Running Lamps/
 Automatic Headlamp
 System 6-2
 Defensive Driving 9-3
 Delayed Entry Lighting 6-7
 Delayed Exit Lighting 6-7
 Delayed Headlamps 6-3
 Delayed Locking 2-7
 Devices
 Auxiliary 7-31
 Distracted Driving 9-2
 Dome Lamps 6-5
 Door
 Ajar Messages 5-35
 Delayed Locking 2-7
 Locks 2-6
 Power Locks 2-7
 Drive Belt Routing, Engine 12-4

Drive Systems	
All-Wheel Drive	9-25, 10-23
Driver Information	
Center (DIC)	5-25, 5-31
Driving	
Characteristics and	
Towing Tips	9-47
Defensive	9-3
Drunk	9-3
For Better Fuel Economy	1-27
Hill and Mountain Roads	9-6
If the Vehicle is Stuck	9-9
Loss of Control	9-5
Off-Road Recovery	9-5
Vehicle Load Limits	9-9
Wet Roads	9-6
Winter	9-7
Dual Automatic Climate	
Control System	8-4

E

Electrical Equipment,	
Add-On	9-54
Electrical System	
Engine Compartment	
Fuse Block	10-29
Fuses and Circuit	
Breakers	10-29
Instrument Panel Fuse	
Block	10-33
Overload	10-29
Emergency	
OnStar®	14-2
Engine	
Air Cleaner/Filter	10-11
Check and Service Engine	
Soon Light	5-18
Compartment Overview	10-5
Coolant	10-12
Coolant Temperature	
Gauge	5-14
Coolant Temperature	
Warning Light	5-23

Engine (cont'd)	
Cooling System	10-12
Cooling System Messages	5-36
Cover	10-6
Drive Belt Routing	12-4
Exhaust	9-21
Heater	9-17
Oil Life System	10-9
Oil Messages	5-37
Overheated Protection	
Operating Mode	10-18
Overheating	10-16
Power Messages	5-37
Pressure Light	5-24
Running While Parked	9-21
Starting	9-16
Entry Lighting	6-6
Equipment, Towing	9-52
Event Data Recorders	13-14
Extender, Safety Belt	3-21
Exterior Lamp Controls	6-1

F

Features
 Memory 1-8
 Filter,
 Engine Air Cleaner 10-11
 Flash-to-Pass 6-2
 Flashers, Hazard Warning 6-3
 Flat Tire 10-56
 Changing 10-57
 Floor Mats 10-82
 Fluid
 Automatic Transmission 10-10
 Brakes 10-21
 Power Steering 10-19
 Washer 10-19
 Fog Lamps
 Bulb Replacement 6-4
 Folding Mirrors 2-15
 Forward Collision Alert
 (FCA) System 9-32
 Frequency Statement
 Radio 13-12
 Front Seats
 Adjustment 3-3
 Heated and Cooled 3-8

Fuel 9-42
 Additives 9-44
 Economy Driving 1-27
 Filling a Portable Fuel
 Container 9-46
 Filling the Tank 9-44
 Foreign Countries 9-44
 Gauge 5-13
 Requirements, California 9-43
 System Messages 5-38
 Fuses
 Engine Compartment
 Fuse Block 10-29
 Fuses and Circuit
 Breakers 10-29
 Instrument Panel Fuse
 Block 10-33

G

Garage Door Opener 5-52
 Programming 5-52
 Gauges
 Engine Coolant
 Temperature 5-14
 Fuel 5-13
 Odometer 5-13

Gauges (cont'd)
 Speedometer 5-13
 Tachometer 5-13
 Voltmeter 5-15
 Warning Lights and
 Indicators 5-11
 General Information
 Service and Maintenance 11-1
 Towing 9-46
 Vehicle Care 10-2
 Glove Box 4-2
 GM Mobility Reimbursement
 Program 13-5

H

Hazard Warning Flashers 6-3
 Head Restraints 3-2
 Headlamps
 Aiming 10-26
 Bulb Replacement 10-26
 Daytime Running Lamps/
 Automatic Headlamp
 System 6-2
 Delayed 6-3

Headlamps (cont'd)	
Flash-to-Pass	6-2
High-Beam On Light	5-25
High/Low Beam Changer	6-2
Heated	
Steering Wheel	5-4
Heated and Cooled Front	
Seats	3-8
Heated Mirrors	2-16
Heater	
Engine	9-17
Heating and Air Conditioning ...	8-1
High Voltage Devices and	
Wiring	10-28
High-Beam On Light	5-25
Hill and Mountain Roads	9-6
Hill Start Assist (HSA)	9-28
Hood	10-4
Horn	5-5
How to Wear Safety Belts	
Properly	3-15

I

Ignition Positions	9-14
Ignition Transmission Lock	
Check	10-24
Immobilizer	2-13
Indicator	
Vehicle Ahead	5-22
Infants and Young Children,	
Restraints	3-38
Infotainment	7-1
Infotainment System	13-15
Instrument Cluster	5-12
Instrument Panel	
Storage Area	4-1
Interior Rearview Mirrors	2-16
Introduction	iii

J

Jump Starting	10-67
---------------------	-------

K

Key and Lock Messages	5-38
Keyless Entry	
Remote (RKE) System	2-2
Keys	2-1

L

Labeling, Tire Sidewall	10-37
Lamps	
Courtesy	6-5
Dome	6-5
Exterior Controls	6-1
License Plate	10-27
Malfunction Indicator	5-18
Messages	5-38
Reading	6-6
Lane Departure	
Warning (LDW)	9-41
Lane Departure Warning	
Light	5-22
Lap-Shoulder Belt	3-16
LATCH System	
Replacing Parts after a	
Crash	3-51
LATCH, Lower Anchors and	
Tethers for Children	3-44
Liftgate	2-8

Lighting
 Delayed Entry 6-7
 Delayed Exit 6-7
 Entry 6-6
 Illumination Control 6-5
 Parade Dimming 6-7

Lights
 Airbag Readiness 5-16
 Antilock Brake System
 (ABS) Warning 5-21
 Brake System Warning 5-20
 Charging System 5-17
 Cruise Control 5-25
 Engine Coolant
 Temperature Warning 5-23
 Engine Oil Pressure 5-24
 Flash-to-Pass 6-2
 High-Beam On 5-25
 High/Low Beam Changer 6-2
 Lane Departure Warning 5-22
 Safety Belt Reminders 5-15
 Security 5-24
 StabiliTrak® Indicator 5-23
 Tire Pressure 5-23
 Tow/Haul Mode 5-22

Locks
 Automatic Door 2-7
 Delayed Locking 2-7
 Door 2-6
 Lockout Protection 2-7
 Power Door 2-7
 Safety 2-8
 Loss of Control 9-5
 Lower Anchors and Tethers
 for Children (LATCH
 System) 3-44
 Lumbar Adjustment 3-4
 Front Seats 3-4

M

Maintenance
 Records 11-14
 Maintenance and Care
 Additional 11-8
 Maintenance Schedule 11-2
 Recommended Fluids
 and Lubricants 11-12
 Malfunction Indicator Lamp 5-18
 Manual Mode 9-24
 Memory Features 1-8
 Memory Seats 3-6

Messages
 Airbag System 5-41
 Battery Voltage and
 Charging 5-34
 Brake System 5-35
 Door Ajar 5-35
 Engine Cooling System 5-36
 Engine Oil 5-37
 Engine Power 5-37
 Fuel System 5-38
 Key and Lock 5-38
 Lamp 5-38
 Object Detection System 5-39
 Ride Control System 5-41
 Security 5-41
 Service Vehicle 5-42
 Tire 5-42
 Transmission 5-43
 Vehicle 5-34
 Vehicle Reminder 5-44
 Vehicle Speed 5-44
 Washer Fluid 5-44

Mirrors	
Automatic Dimming	
Rearview	2-17
Convex	2-14
Folding	2-15
Heated	2-16
Manual Rearview	2-17
Park Tilt	2-16
Power	2-15
Mirrors, Interior Rearview	2-16
Monitor System, Tire	
Pressure	10-44
MP3	7-24, 7-29
Multi-band Antenna	7-19

N

Navigation	
OnStar®	14-3
Net, Convenience	4-4
New Vehicle Break-In	9-14

O

Object Detection System	
Messages	5-39
Odometer	5-13
Off-Road	
Recovery	9-5
Oil	
Engine	10-7
Engine Oil Life System	10-9
Messages	5-37
Pressure Light	5-24
Older Children, Restraints	3-36
Online Owner Center	13-4
OnStar	13-15
OnStar®	
System, In Brief	1-28
OnStar® Additional	
Information	14-6
OnStar® Connections	14-4
OnStar® Emergency	14-2
OnStar® Navigation	14-3
OnStar® Overview	14-1
OnStar® Security	14-3
OnStar® Vehicle	
Diagnostics	14-6

Operating Mode	
Overheated Engine	
Protection	10-18
Operation, Infotainment	
System	7-5, 7-8
Ordering	
Service Publications	13-11
Outlets	
Power	5-9
Overheated Engine	
Protection	
Operating Mode	10-18
Overheating, Engine	10-16
Overview, Infotainment	
System	7-3, 7-5

P

Parade Dimming	6-7
Park	
Shifting Into	9-19
Shifting Out of	9-20
Tilt Mirrors	2-16

Parking
 Brake 9-27
 Brake and P (Park)
 Mechanism Check 10-24
 Over Things That Burn 9-20
 Parking Assist 9-34
 Passenger Airbag Status
 Indicator 5-17
 Passenger Compartment Air
 Filter 8-12
 Passenger Sensing System ... 3-30
 Perchlorate Materials
 Requirements, California 10-2
 Personalization
 Vehicle 5-45
 Phone
 Bluetooth 7-34
 Power
 Door Locks 2-7
 Mirrors 2-15
 Outlets 5-9
 Protection, Battery 6-8
 Retained Accessory (RAP) ... 9-18
 Seat Adjustment 3-4
 Steering Fluid 10-19
 Windows 2-17

Pregnancy, Using Safety
 Belts 3-21
 Privacy
 Vehicle Data Recording 13-14
 Program
 Courtesy Transportation 13-7
 Proposition 65 Warning,
 California 10-2

R

Radio Frequency
 Identification (RFID) 13-12
 Radio Frequency
 Statement 13-12
 Radios
 AM-FM Radio 7-10, 7-12
 Reception 7-19
 Satellite 7-15, 7-18
 Reading Lamps 6-6
 Rear Climate Control
 System 8-9, 8-10
 Rear Seat Audio (RSA)
 System 7-32
 Rear Seat Entertainment System
 Rear Seat Audio (RSA) 7-32
 Rear Seats 3-9

Rear Vision Camera (RVC) 9-38
 Rear Window Washer/Wiper 5-5
 Rearview Mirrors 2-17
 Automatic Dimming 2-17
 Reclining Seatbacks 3-5
 Recommended Fluids and
 Lubricants 11-12
 Records
 Maintenance 11-14
 Recreational Vehicle
 Towing 10-71
 Reimbursement Program,
 GM Mobility 13-5
 Remote Keyless Entry (RKE)
 System 2-2
 Remote Vehicle Start 2-4
 Replacement Bulbs 10-28
 Replacement Parts
 Airbags 3-36
 Maintenance 11-13
 Replacing Airbag System 3-36
 Replacing LATCH System
 Parts after a Crash 3-51
 Replacing Safety Belt
 System Parts after a Crash ... 3-22

Reporting Safety Defects	
Canadian Government	13-13
General Motors	13-13
U.S. Government	13-12
Restraints	
Where to Put	3-43
Retained Accessory	
Power (RAP)	9-18
Ride Control Systems	
Messages	5-41
Roads	
Driving, Wet	9-6
Roadside Assistance	
Program	13-5
Roof	
Sunroof	2-19
Roof Rack System	4-5
Rotation, Tires	10-49
Routing, Engine Drive Belt	12-4
Running the Vehicle While	
Parked	9-21

S

Safety Belts	3-13
Care	3-22
Extender	3-21
How to Wear Safety Belts	
Properly	3-15
Lap-Shoulder Belt	3-16
Reminders	5-15
Replacing after a Crash	3-22
Use During Pregnancy	3-21
Safety Defects Reporting	
Canadian Government	13-13
General Motors	13-13
U.S. Government	13-12
Safety Locks	2-8
Safety System Check	3-21
Satellite Radio	7-15, 7-18
Scheduling Appointments	13-7
Seats	
Adjustment, Front	3-3
Head Restraints	3-2
Lumbar Adjustment, Front	3-4
Memory	3-6
Power Adjustment, Front	3-4

Seats (cont'd)	
Rear	3-9
Reclining Seatbacks	3-5
Third Row Seat	3-11
Securing Child	
Restraints	3-51, 3-53
Security	
Light	5-24
Messages	5-41
OnStar®	14-3
Vehicle	2-12
Vehicle Alarm	2-12
Service	
Accessories and	
Modifications	10-2
Doing Your Own Work	10-3
Engine Soon Light	5-18
Maintenance Records	11-14
Maintenance, General	
Information	11-1
Parts Identification Label	12-1
Publications Ordering	
Information	13-11
Scheduling Appointments	13-7
Vehicle Messages	5-42
Services	
Special Application	11-8

Servicing the Airbag 3-34
 Settings 7-41
 Shift Lock Control Function
 Check, Automatic
 Transmission 10-24
 Shifting
 Into Park 9-19
 Out of Park 9-20
 Side Blind Zone
 Alert (SBZA) 9-36
 Signals, Turn and
 Lane-Change 6-4
 Spare Tire
 Compact 10-66
 Special Application Services ... 11-8
 Specifications and
 Capacities 12-2
 Speedometer 5-13
 StabiliTrak
 Indicator Light 5-23
 Start Assist, Hills 9-28
 Start Vehicle, Remote 2-4
 Starter Switch Check 10-23
 Starting the Engine 9-16

Steering 9-4
 Fluid, Power 10-19
 Heated Wheel 5-4
 Wheel Adjustment 5-2
 Wheel Controls 5-2, 5-3
 Storage Areas
 Armrest 4-2
 Cargo Cover 4-3
 Cargo Management System ... 4-3
 Center Console 4-2
 Convenience Net 4-4
 Glove Box 4-2
 Instrument Panel 4-1
 Roof Rack System 4-5
 Storage Compartments 4-1
 Stuck Vehicle 9-9
 Summer Tires 10-37
 Sun Visors 2-19
 Sunroof 2-19
 Symbols iv
 System
 Forward Collision
 Alert (FCA) 9-32
 Infotainment 7-1, 13-15
 Roof Rack 4-5

T

Tachometer 5-13
 Taillamps
 Turn Signal and
 Stoplamps 10-26
 Text Telephone (TTY) Users ... 13-4
 Theft-Deterrent Systems 2-13
 Immobilizer 2-13
 Third-Row Seats 3-11
 Time 5-7, 5-8
 Tires 10-35
 All-Season 10-36
 Buying New Tires 10-51
 Chains 10-55
 Changing 10-57
 Compact Spare 10-66
 Designations 10-39
 Different Size 10-52
 If a Tire Goes Flat 10-56
 Inflation Monitor System ... 10-45
 Inspection 10-48
 Messages 5-42
 Pressure Light 5-23
 Pressure Monitor System ... 10-44
 Rotation 10-49
 Sidewall Labeling 10-37

Tires (cont'd)	
Terminology and Definitions	10-40
Uniform Tire Quality Grading	10-53
Wheel Alignment and Tire Balance	10-54
Wheel Replacement	10-55
When It Is Time for New Tires	10-50
Winter	10-37
Tow/Haul Mode	9-25
Tow/Haul Mode Light	5-22
Towing	
Driving Characteristics	9-47
Equipment	9-52
General Information	9-46
Recreational Vehicle	10-71
Trailer	9-50
Vehicle	10-70
Traction Control/Electronic Stability Control	9-28
Trademarks and License Agreements	7-43
Trailer Towing	9-50

Transmission	
Automatic	9-22
Fluid, Automatic	10-10
Messages	5-43
Transportation Program, Courtesy	13-7
Turn and Lane-Change Signals	6-4

U

Uniform Tire Quality Grading	10-53
Universal Remote System	5-52
Operation	5-55
Programming	5-52
Using This Manual	iii

V

Vehicle	
Alarm System	2-12
Canadian Owners	iii
Control	9-3
Identification	
Number (VIN)	12-1

Vehicle (cont'd)	
Load Limits	9-9
Messages	5-34
Personalization	5-45
Reminder Messages	5-44
Remote Start	2-4
Security	2-12
Speed Messages	5-44
Towing	10-70
Vehicle Ahead Indicator	5-22
Vehicle Care	
Tire Pressure	10-43
Vehicle Data Recording and Privacy	13-14
Vehicle Diagnostics	
OnStar®	14-6
Ventilation, Air	8-11
Visors	2-19
Voltage Devices and Wiring	10-28
Voltmeter Gauge	5-15

W

Warning		Wiper Blade Replacement	10-25
Brake System Light	5-20	Wipers	
Lane Departure (LDW)	9-41	Rear Washer	5-5
Warning Lights, Gauges,		Wiring, High Voltage	
and Indicators	5-11	Devices	10-28
Warnings	iv		
Cautions and Danger	iv		
Hazard Flashers	6-3		
Washer Fluid	10-19		
Messages	5-44		
Wheels			
Alignment and Tire			
Balance	10-54		
Different Size	10-52		
Replacement	10-55		
When It Is Time for New			
Tires	10-50		
Where to Put the Restraint	3-43		
Windows	2-17		
Power	2-17		
Windshield			
Wiper/Washer	5-5		
Winter			
Driving	9-7		
Winter Tires	10-37		

